

# CorkSport Performance

## AXO-3-469-1X Rear Big Brake Kit

Installation Instructions for the CorkSport Performance Rear Big Brake Kit for the 2019+ Mazda3

Written By: Quintin Gunn



## INTRODUCTION

In this installation guide we have provided step by step instructions to remove the OEM rear brakes and install the CorkSport Performance Big Brake Kit.

### Advisory:

- Working under the vehicle requires a safe and sturdy location for the vehicle to sit on jackstands.
- Brake bleeding & pad bedding must be done properly to prevent braking issues. Follow the instructions carefully to prevent vehicle damage or personal injury.
- Proper inspection of the wheel clearance to the brake caliper must be performed to prevent damage to the caliper and/or wheel

The following brake pads series may operate with the CorkSport Rear BBK. Other brake pad manufacturers may have pad designs for this configuration that is not listed here:

Hawk – HB107

Alcon - 1749

AP Racing – CP23400D40, CP23400D38, CP23400D43

Ferodo - FRP3091

 **TOOLS:**

- Hydraulic Jack (1)
- Jack Stand (2)
- 3/8" Drive Ratchet (1)
- 1/2" Drive Breaker Bar (1)
- 1/2" Torque Wrench (1)
- 14mm Socket - Deep (1)
- 17mm Socket - Deep (1)
- 21mm Socket - Deep (1)
- 7mm Allen Key Socket (1)
- 10mm Allen Key Socket (1)
- 12mm Allen Key Socket (1)
- Wrench, 10mm (1)
- Wrench, 14mm (1)
- Wrench, 17mm (1)
- Wrench, 19mm (1)
- 10mm Line Wrench (1)
- Small Needle Nose Pliers (1)
- Flathead Screwdriver (1)
- Shop Towels/Rags (1)
- Drip Pan (1)
- Gloves (1)
- Blue Threadlocker (1)
- Plastic Bottle (1)
- 5/32" Hose (1)
- Brake Fluid - DOT3 (1)
- Friend (1)

 **PARTS:**

- CorkSport Left Side 330mm Brake Rotor (1)
- CorkSport Right Side 330mm Brake Rotor (1)
- CorkSport Left Side Brake Caliper (1)
- CorkSport Right Side Brake Caliper (1)
- CorkSport Stainless Steel Brake Lines (2)
- M10 Banjo Bolt (2)
- M10 Crush Washer (4)
- M14x35mm Socket Head Cap Screw (4)
- M12x60mm Socket Head Cap Screw (4)
- M12 Washers (4)
- M14 Washers (4)
- Touch Up Paint (1)

## Step 1 — Getting Started



- First and foremost; **THANK YOU** for becoming a part of the CorkSport Family. We hope to bring you the highest level of Parts, Customer Service, & Support
- ⓘ How To Use These Instructions
  - The instruction format will relate colored marking in the image to the color dot in the text to the right of the image
- ⓘ **A wheel fitment template can be found at the end of this document if you want to check wheel fitment with the rear big brake kit before beginning the install**

## Step 2 — Lifting the Car & Removing the Rear Wheels



**⚠️ Ensure the vehicle is parked on a level surface before proceeding.**

- Start by lifting up the rear of the car using the hydraulic jack and jack stands.

**⚠️ Be sure to reference your owners manual for jack points and the jack manufacturer's instructions for proper practices.**

- Remove the rear wheels from the vehicle

### Step 3 — Activate Maintenance Mode



- ① This step must be performed to increase the clearance between the brake pads and discs to make disassembly easier
- Turn the ignition ON (no brake, engine off)
- Release the Parking Brake as normal
- Push the Accelerator Pedal all the way down (past the Kickdown switch on AT cars), and continue to hold
- Push and hold down the Parking Brake Switch
- Press the Start Button 3 times rapidly (Off -> Acc -> Ignition on again)
- Verify that the Amber Brake Control System Warning Light is on the Dashboard and the Parking Brake Motor made noise for longer than usual
- Turn the ignition off

## Step 4 — Disconnect the Battery

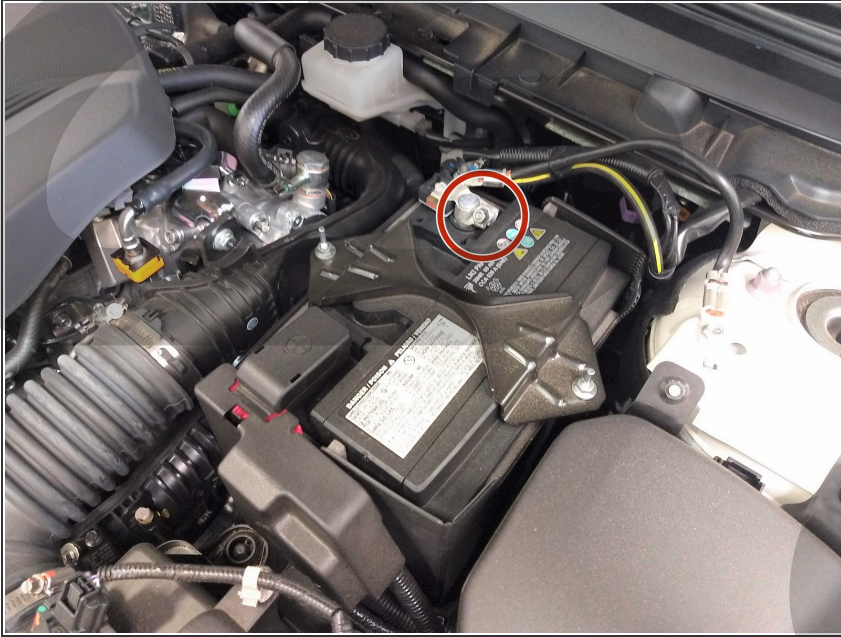

- With a 10mm socket and ratchet, disconnect the negative terminal of the battery and tuck out of the way

## Step 5 — Disconnect the Brake Line

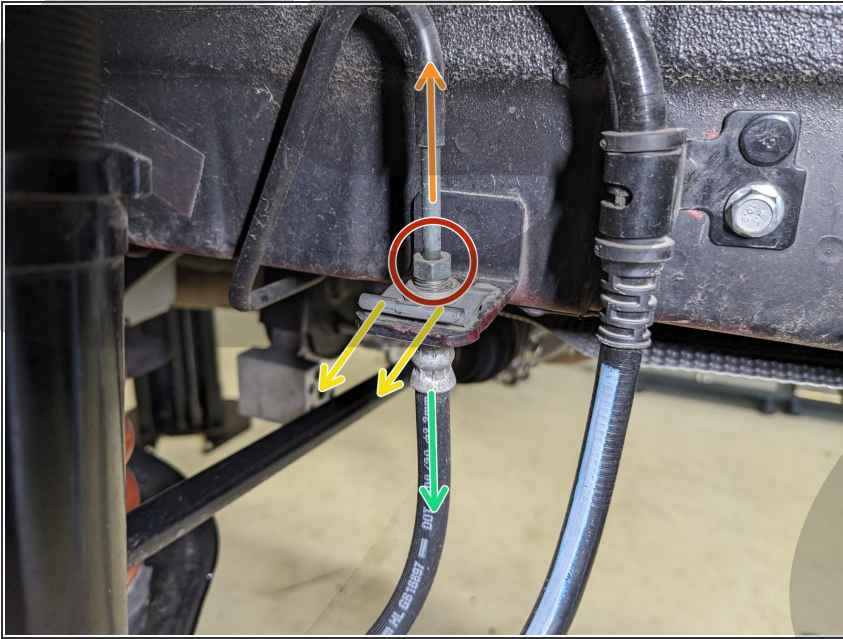

**⚠** Ensure to catch brake fluid with a drip pan once the line is loosened. Brake fluid can remove paint and coatings, and damage clothing. Be cautious if the fluid is spilled. Using a small vacuum cap to block the end of the hardline will prevent any unnecessary fluid leakage

- Using a 10mm Flare Nut wrench, unscrew the flare nut from the brake line
- Free the rear brake line from the mounting bracket by pulling it upwards and out of the rubber hose
- With a pair of pliers or a flathead screwdriver, remove the retaining clip shown
- Pull the brake line out of the bracket

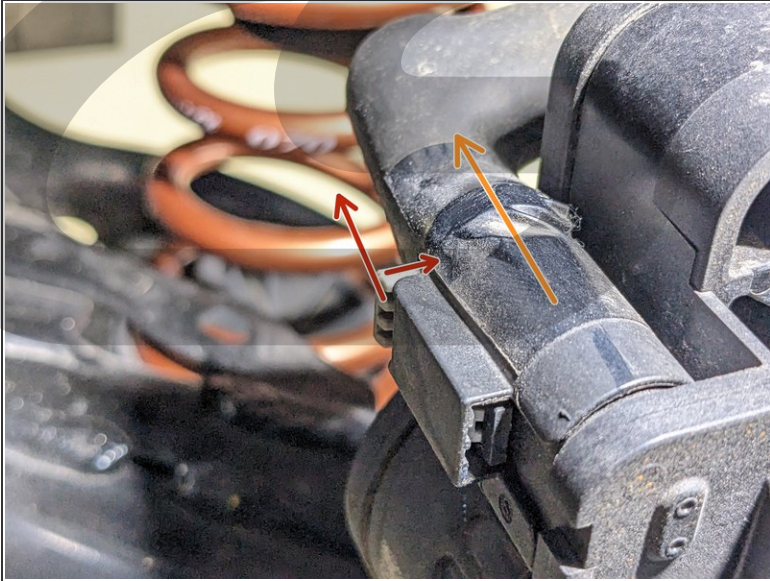

**Step 6 — Disconnect the Parking Brake Cable Wire**

- Unplug the Parking Brake Cable Wire by pushing the Grey Tab in the direction shown until it clicks, then pinch inwards
- Pull on the Connector to disconnect it from the Motor
- Place in a position that is clear and out of the way

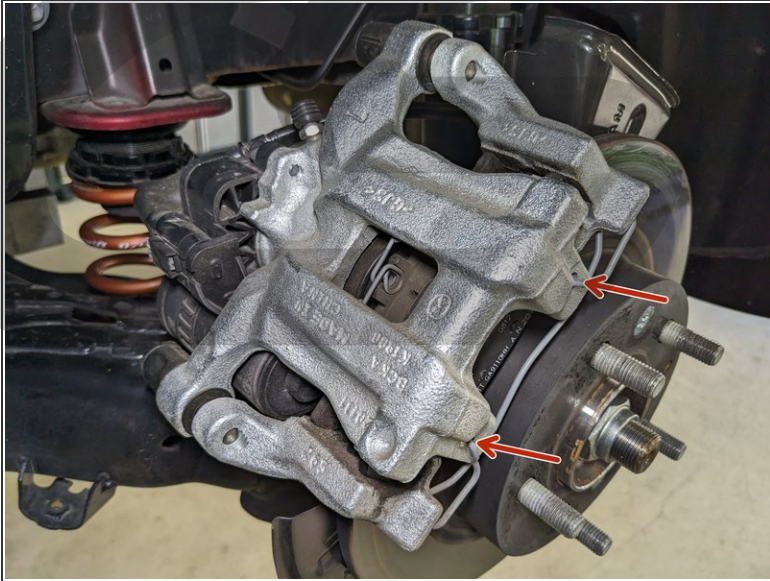
**Step 7 — Removing the OEM Rear Brake Caliper & Rotor - Part 1**

- Remove the Spring Clip from the Brake Caliper with a pair of pliers. Pull outward, away from the vehicle

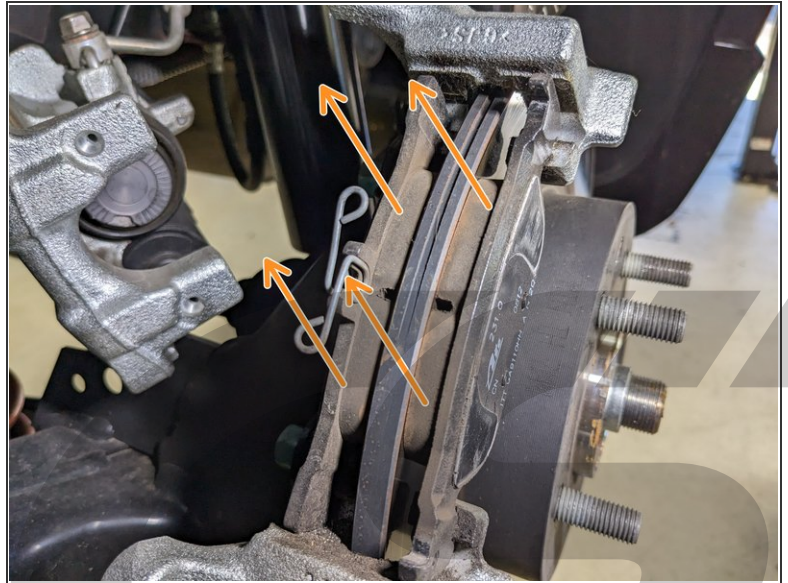
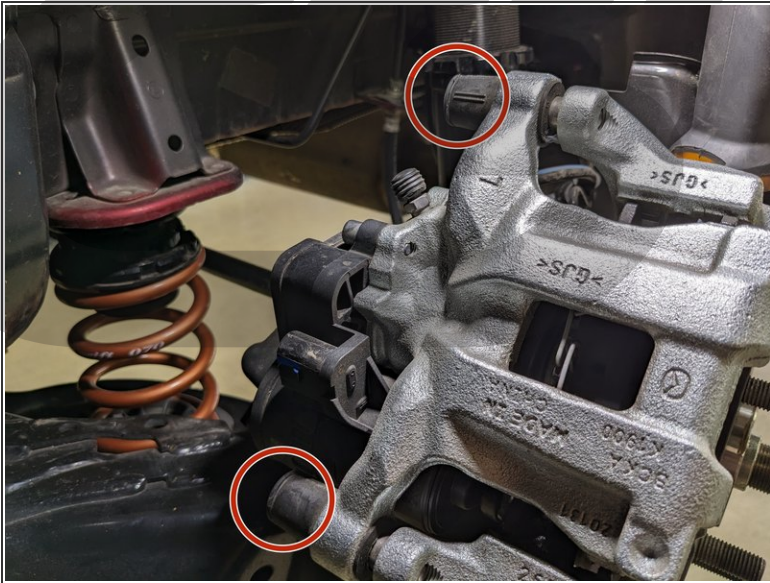
**Step 8 — Removing the OEM Rear Brake Caliper & Rotor - Part 2**

- Remove the Dust Caps covering the Two(2) Brake Caliper Bolts
  - With a 7mm Allen Key or Allen Key socket, remove the Two(2) Brake Caliper Bolts
- Remove the Brake Caliper from the vehicle by pulling away from the brake rotor
  - ⓘ Ensure to have a firm grip on the caliper to prevent dropping it
- Remove the Brake Pads by pulling away from the brake rotor

## Step 9 — Removing the OEM Rear Brake Caliper & Rotor - Part 3



- With a 14mm Socket and Ratchet, remove the bolts securing the Brake Caliper Bracket
  - Remove the bracket from the vehicle
- Remove the two Philips Head screws with a Large Screwdriver
  - Remove the Brake Rotor from the Vehicle

## Step 10 — CorkSport Caliper Bracket and Parking Brake Installation

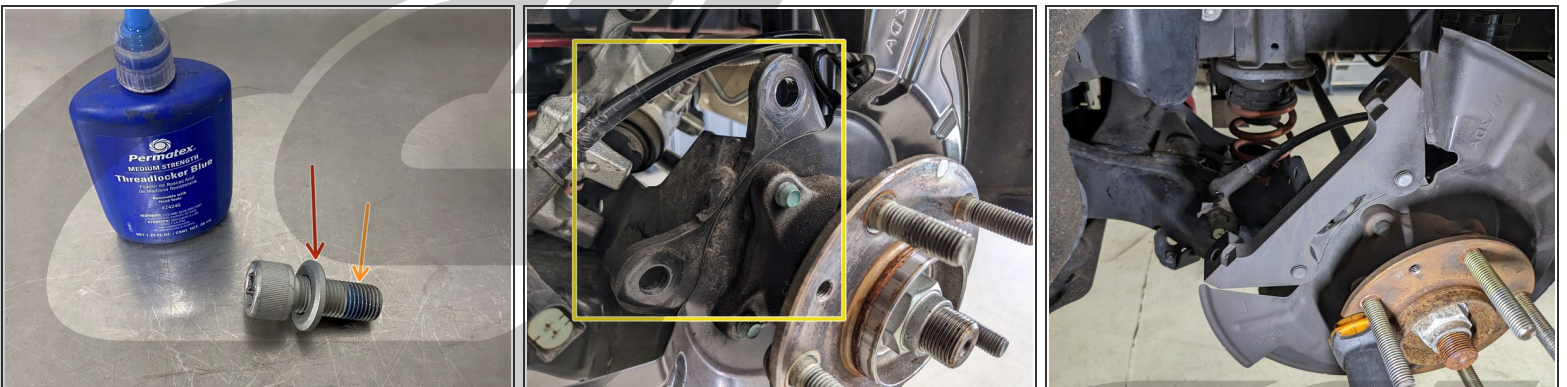

- Locate two of the M14 bolts and ensure they each have an M14 washer
- Apply blue threadlocker to the two M14 bolts
- Install the Brake Caliper Bracket and Parking Brake assembly in the OEM bracket location, as shown
- ⓘ The bracket must be oriented so the Tab Protrusions face the inside of the vehicle
- Secure the caliper bracket from the backside with the M14 bolts and using a 12mm Allen socket torque to **64-71ft-lbs**

## Step 11 — CorkSport Brake Rotor Installation

### ROTOR ROTATION IDENTIFICATION:



- Locate the driver's side (left side) brake rotor
  - ⚠ The orientation of the slots in the brake rotor changes for driver and passenger side. Ensure you get the correct rotor.
- Install the CorkSport brake rotor onto the vehicle
  - ⓘ If needed to help keep the brake rotor in position for the next step, you can loosely tighten a lug nut against the brake rotor
  - ⚠ If the brake rotor is hitting the caliper bracket installed earlier, the caliper bracket was installed in the incorrect orientation

## Step 12 — CorkSport Brake Caliper Installation



- Locate the driver's side (left side) CorkSport brake caliper
- Notice that the Brake Caliper will have a "direction of rotation" sticker
  - ⚠ Ensure the caliper is installed with the arrow in this sticker pointing in the direction of forward wheel rotation
- Locate two of the M12 bolts. If not already present, install one M12 washer on each bolt
- Apply blue threadlocker to the two M12 bolts
- Lift the driver's side caliper into position with the installed Caliper Bracket and secure with the two M12 bolts using a 10mm Allen socket
  - Torque to **64-71 ft-lbs**

## Step 13 — Brake Caliper Alignment



- ⓘ Your kit is specifically designed to center the brake rotor exactly in the middle of the caliper
- ⓘ The kit also is designed to position the brake pad very slightly inboard from the edge of the brake rotor
- ⓘ Shims are supplied in your kit if needed for repositioning the brake caliper to fit correctly, however, we have never needed to use shims when installing this kit. Do not use **any** unless 100% necessary

## Step 14 — Transfer the Parking Brake Motor - Part 1

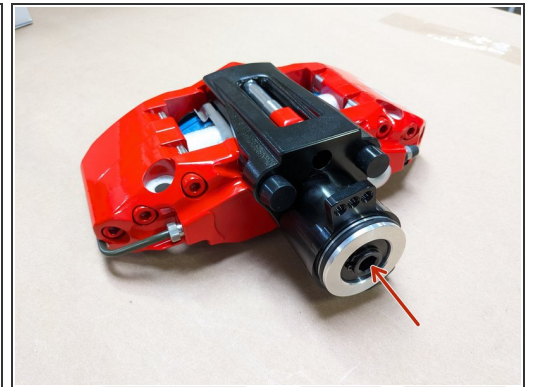
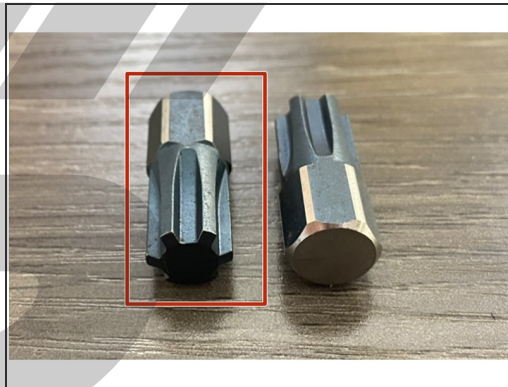
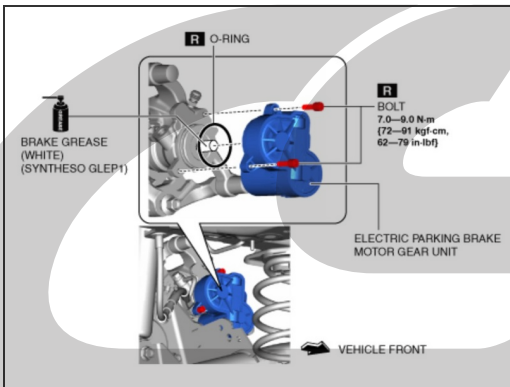

- On a workbench, remove the Electric Parking brake motor and O-ring from the OEM Brake Calipers by removing the Two(2) bolts shown in the first image
- ⓘ If your CorkSport caliper came with an O-ring pre-installed, the OEM one does not need to be swapped and can remain on the OEM caliper
- Install one of the provided adapter pieces into the Brake Caliper in the location shown
- ⓘ The Caliper is removed for demonstration purposes

## Step 15 — Transfer the Parking Brake Motor - Part 2

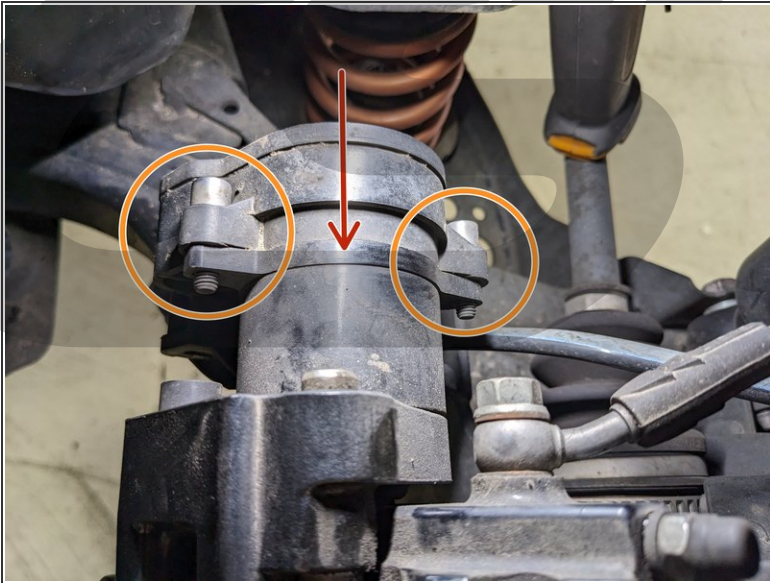

- Install the Motor and O-ring onto the back of the CorkSport Brake Calipers in the location shown
- ⓘ If your CorkSport caliper came with an O-ring pre-installed, the OEM one does not need to be swapped and can remain on the OEM caliper
- ⚠ Be sure to install the motors on their original sides (Driver's side to Driver's side, Passenger to Passenger Side)
- Tighten the Two(2) bolts to **62-79 in-lbf**
- Connect the Parking Brake Electrical cable to the Motor Connector



## Step 16 — Brake Line Installation - Part 1

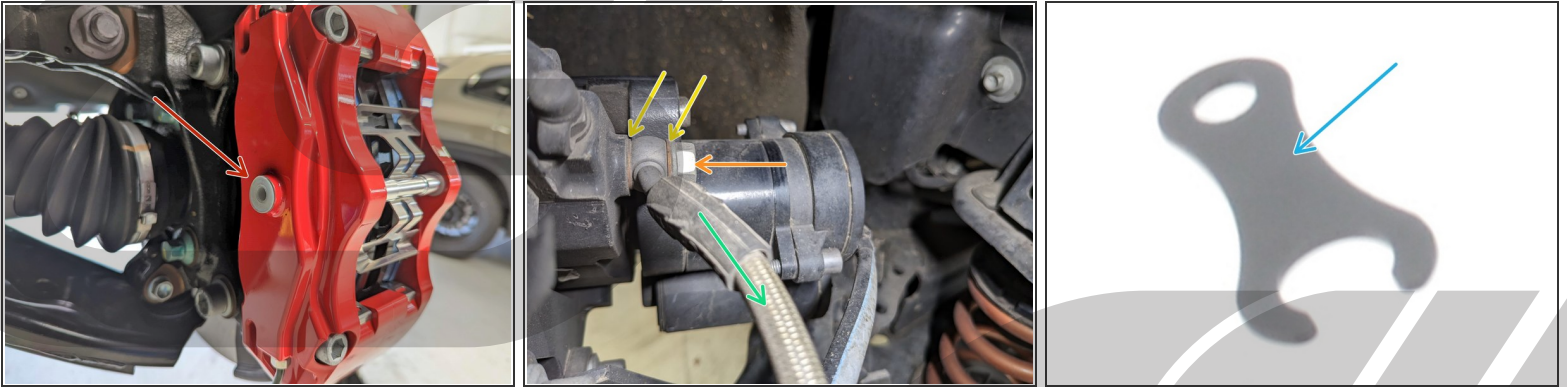

- Remove the dust cover from the backside of the CorkSport Brake caliper
- Install the rounded end of the brake line onto the Brake Caliper as shown
  - Secure the brake line with one of the supplied M10 banjo bolts
  - Ensure there is one copper washer on either side of the brake line fitting
  - Ensure the CorkSport brake line is orientated as shown
- Tighten the Banjo Bolt to **15-19ft-lbs**
- If your kit was shipped with Brake Line Mounting Brackets, these are not used and may be discarded

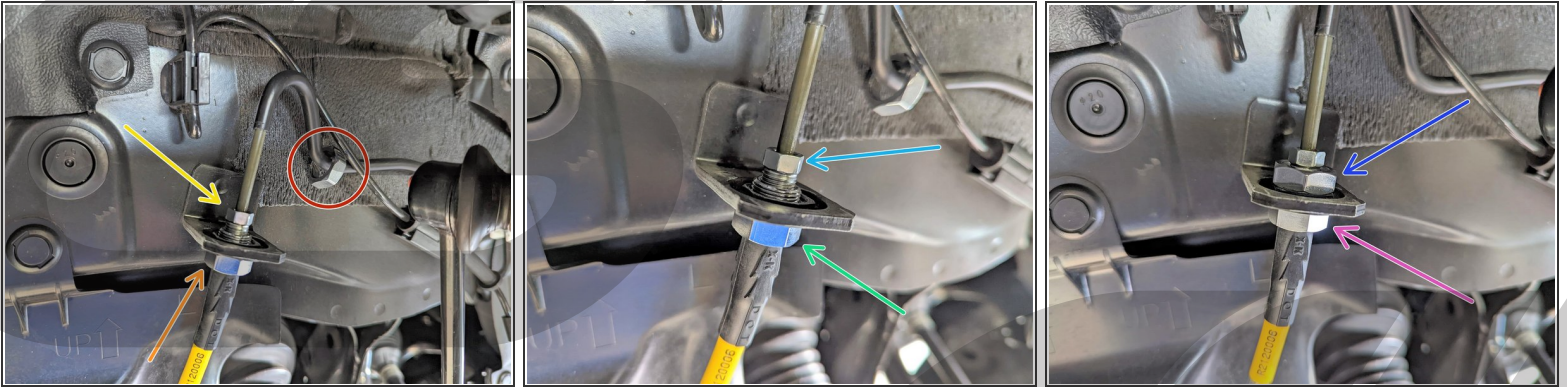
**Step 17 — Brake Line Installation - Part 2**

- Remove the 19mm nut from the end of the CorkSport brake line and slide it over the OEM hardline on the inner fender. Slide it down along the hardline to keep it out of the way
- Slide the end of the CS brake line through the brake line bracket, in place of the OEM rubber line
- Position the OEM hardline into the CS brake line. Thread in the small nut until hand tight
- Hold the CS brake line with a 17mm wrench
- Using a 10mm line wrench, tighten the OEM hardline to the CS brake line until snug
- Bring the 19mm nut down the hardline and hand tighten it to the CS brake line.
- Again hold the CS brake line with a 17mm wrench
- Using a 19mm wrench tighten the 19mm nut to secure the CS brake line to the bracket.

## Step 18 — Passenger's Side Brake Installation



- Repeat steps 10-17 for the passenger's side (right hand side) of the vehicle

## Step 19 — Exit Maintenance Mode



- Reconnect the Negative Terminal on the Battery with a 10mm socket and ratchet
- Turn the ignition ON (no brake, engine off)
- Push the Accelerator Pedal all the way down (past the Kickdown switch on AT cars), and continue to hold
- Pull up and hold the Electric Parking Brake Switch
- Press the Start Button 3 times rapidly (Off -> Acc -> Ignition on again)
- Verify that the Amber Brake Control System Warning Light is no longer on the Dashboard and the Parking Brake Motor made noise for longer than usual
- Turn the ignition off

## Step 20 — Brake Bleeding - Part 1

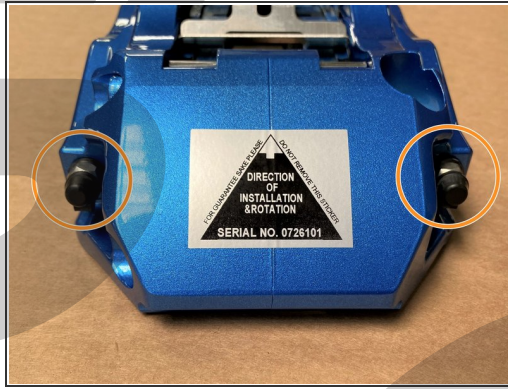
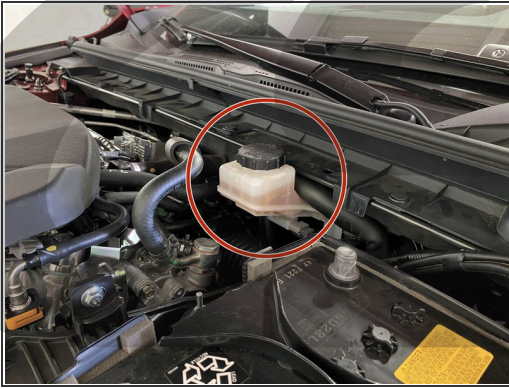

- i "Bleeding" the brakes is the final step before you're ready to drive the car. It removes all air bubbles from the braking system that were introduced during installation
- i We strongly recommend getting a friend to help you bleed your brakes. It makes the whole process much faster & easier
- Locate the Brake Fluid Reservoir under the hood of your vehicle
- i Throughout the bleeding process we will reference this unit
- Locate the two bleed screws at the top of each of your calipers. These will be covered with black rubber dust boots
- Instead of buying a fancy brake bleeder, we recommend getting a plastic bottle and a short section of 5/32" (4mm) hose. Pour some brake fluid in the bottle and place the hose in the bottle like shown in the third image. Ensure the hose is sticking into the brake fluid
- i The bottle will catch excess brake fluid during the bleeding process

## Step 21 — Brake Bleed - Part 2



- The OEM caliper position has the caliper "angle" backwards a bit. When switching to a dual side forged caliper like the caliper in the CorkSport BBK, the angle of the caliper when mounted cause some air to be trapping in the piston bores. This angle is made even worse when the tires are removed and the suspension is hanging.
- When bleeding the rear brakes the calipers need to be sitting more vertical, look at the front brake caliper for reference.
- Options:
  - 1) If you can reach the bleed screws through the wheels spokes: You can drive the rear tires up on ramps to angle the calipers more vertical.
  - 2) If you cannot reach the bleed screws through the wheels spokes and the wheels must be removed: You can lift the vehicle by the torsion beam ends to and raise it up high to help get the brake caliper more vertical.
  - 3) Remove the caliper mounting bolts and rotate the caliper **on the rotor** counter clockwise and hold the caliper on the rotor in a more vertical orientation. Then bleed the brakes.

**⚠ The rotor **MUST** be in-between the brake pads during bleeding**

## Step 22 — Brake Bleeding - Part 3

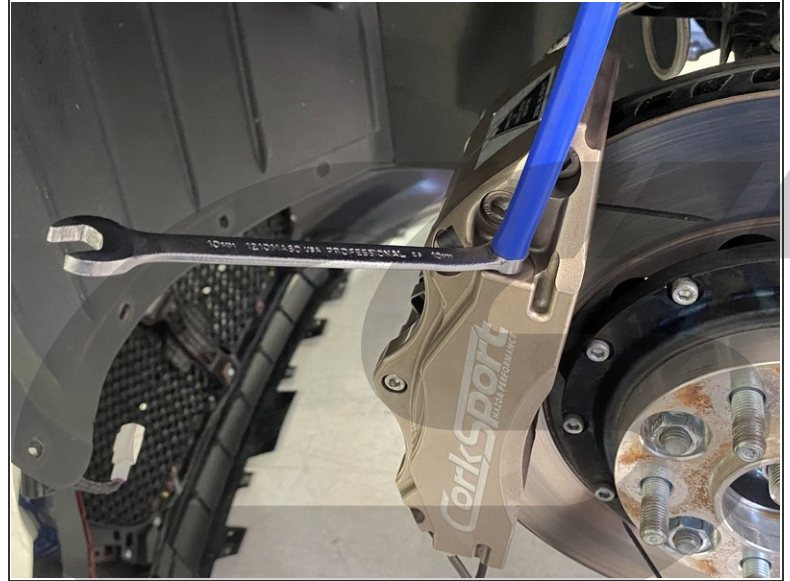

**i** For proper brake bleeding, always start with the bleed screw **furthest** from the master cylinder. In this case we start with the **outer** bleed screw on the **passenger** side, then work your way inward going to the inside Caliper Bleed Screw, then the Parking Brake bleed screw

**⚠ Take care when loosening & tightening the bleed screws to not scratch your fresh calipers!**

- Lift the rubber dust boot from each bleed screw and then, using a 10mm wrench, tighten each bleed screw until snug
- Place a 10mm wrench onto the hex of the outer passenger bleed screw
- Place the other end of your 5/32" hose onto the outer passenger bleed screw. The setup will look like the second image
- Have your friend pump the brakes hard 3-5 times, then hold the brake pedal down
- While your friend holds the pedal, loosen the outer passenger bleed screw. Fluid and air will come out of the bleed screw and the pedal will travel to the floor
- Once the pedal is on the floor, re-tighten the bleed screw. Once tight, your friend can lift their foot from the pedal

## Step 23 — Brake Bleeding - Part 4



- Repeat the pumping & holding procedure from the previous step 3-5 times or until no more air bubbles are coming out of the bleeder hose
- Check fluid level in the master cylinder. Top off with SAE J1703 DOT3 fluid as needed
- ⚠ **Top off brake fluid as needed between each bleed screw**
- Once complete with all bleed screws, complete one final pumping & holding procedure on all bleed screws. Use the same order as before
- By this stage, there should be no air coming from the brake bleed screws and the brake pedal should be firm
- Verify there are no brake fluid leaks and top off your fluid one final time before moving on
- Clean your brake rotors with brake parts cleaner



## Step 24 — Wheel Clearance Inspection



**i** A wheel fitment template can be found at the end of this document to further help you check wheel fitment with the rear big brake kit

**!** This step must be performed prior to driving the vehicle. Failure to do so can result in severe damage to your CorkSport brakes

**i** Throughout this step, pay close attention to the back of the wheel and your brake caliper. We recommend about 1/8" of clearance for safe operation.

**!** For use with OEM wheels, you will need a ~20mm spacer. Extended wheel studs or a "bolt-on" style spacer will be required for a spacer this large

- Gently position a wheel onto the wheel studs. Be careful as some wheels can easily hit the brakes
- If your wheel appears to be clearing, tighten 3 lug nuts until snug. Inspect clearance again after lugs are tightened
- Finally, very slowly rotate the wheel. Verify that you can rotate it with no contact to the brake caliper

## Step 25 — Final Reassembly



- Once happy with clearance install your wheels onto the vehicle and lower your car to the ground
- ⓘ Ensure the Parking Brake is engaged
- Torque your wheels in a star pattern to **80-90ft-lbs**

## Step 26 — Brake Pad Bedding



- ① In order for your brake pads & rotors to wear evenly, you must complete the following procedure to "bed" in the pads & rotors
- ① Carefully drive to an open road with no cars around. You will be performing many accelerations & stops. Do not attempt to stomp on the brakes right after install
- ① You may notice a brake smell and/or some smoke during this operation. This is normal as the brakes will get very hot during bedding
  - Accelerate until ~30MPH. Brake smoothly and evenly until almost stopped and then again accelerate to ~30MPH
  - Repeat the previous step ~10 times
  - Accelerate to ~45MPH. Brake much more aggressively until almost stopped. Then accelerate again until ~45MPH
  - Repeat the previous step ~3 times
  - Drive the car around for 15 minutes to let the brake system cool. The less you use the brakes the better

## Step 27 — Installation Complete



- After bedding, you are now able to drive normally! Some brake squeaking is normal with the CorkSport BBK
- This completes your installation of the CorkSport Performance 13" Big Brake Kit!
- Contact us with any questions or concerns at [sales@corksport.com](mailto:sales@corksport.com) or (360) 260-2675.
- Please leave a review here: <https://corksport.com>
- Share your experience using #CorkSport on Instagram, Facebook, and Twitter.

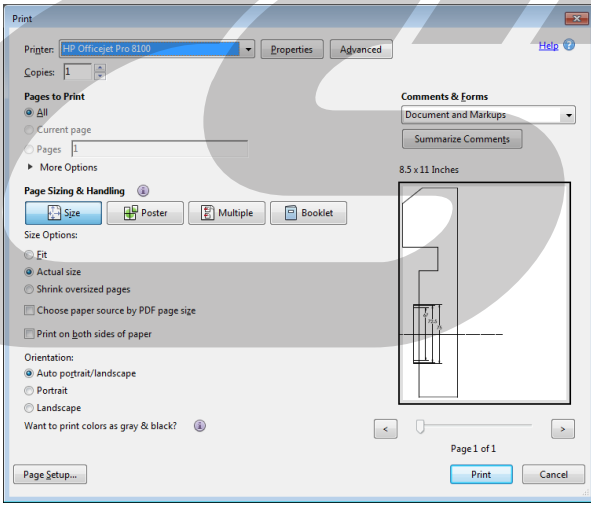

1. Print a copy of the drawing, making sure that the "Size Options" is set at "Actual Size" (or make sure "Scale" is at "100%")

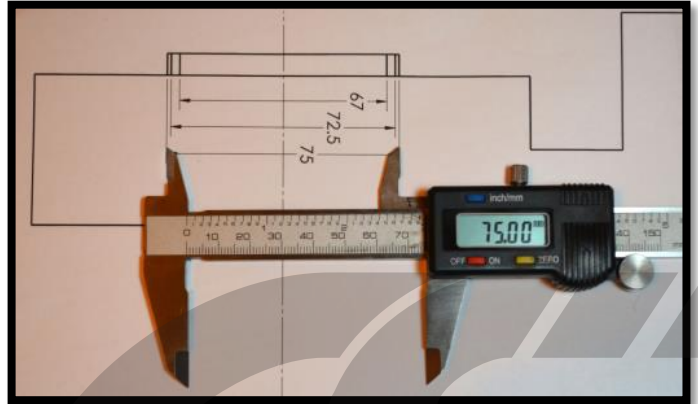

2. Check dimensions to confirm it has been printed to scale.

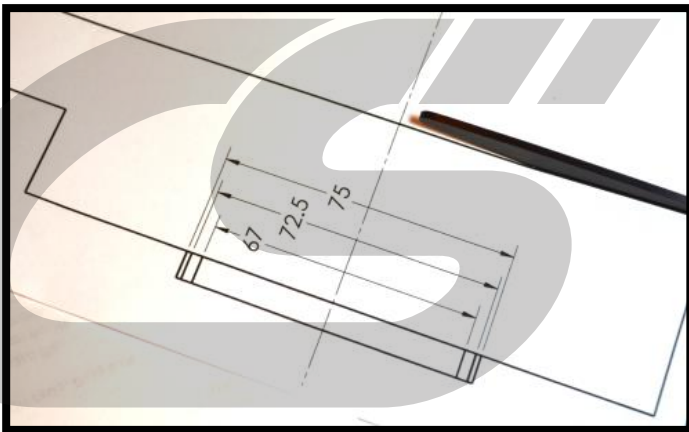

3. Cut the drawing just outside the line. Cut down to hub size of wheel.

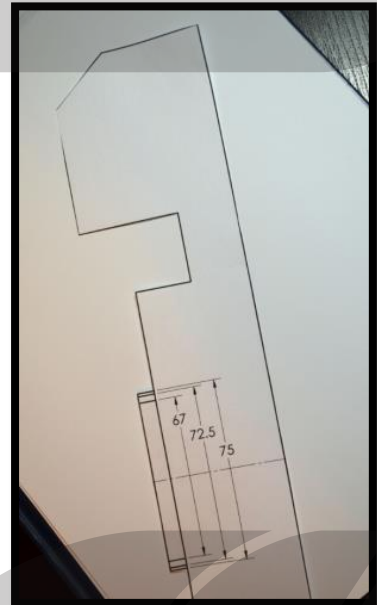

4. Glue the drawing to a stiffer piece of material such as a manila folder to make the template easier to use. Finish by cutting directly along the line.

**PART #: AX0-3-469**

*Need Help With Your Installation? Call (360)260-CORK*



*We absolutely, positively,  
deliver - every time.*

**CORKSPORT.COM**



5. Lay the template inside the wheel as shown. Verify that the edge of the caliper does not touch the rim or the wheel spokes. A minimum clearance of 2mm (0.080") is recommended.

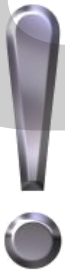

If there is interference, different wheels or a spacer will be necessary. Use of a wheel spacer is at the discretion of the vehicle owner. Typically a properly made spacer of 2-3mm will not adversely affect the vehicle. Issues that must be addressed before utilizing a wheel spacer include, but are not limited to, fender clearance, proper wheel bolt or stud length, effect on vehicle handling, and centering of the wheel. Wheel fitment and the use of wheel spacers with our brake caliper upgrade is the responsibility of the customer.

**PART #: AX0-3-469**

*Need Help With Your Installation? Call (360)260-CORK*



*We absolutely, positively,  
deliver - every time.*

**CORKSPORT.COM**

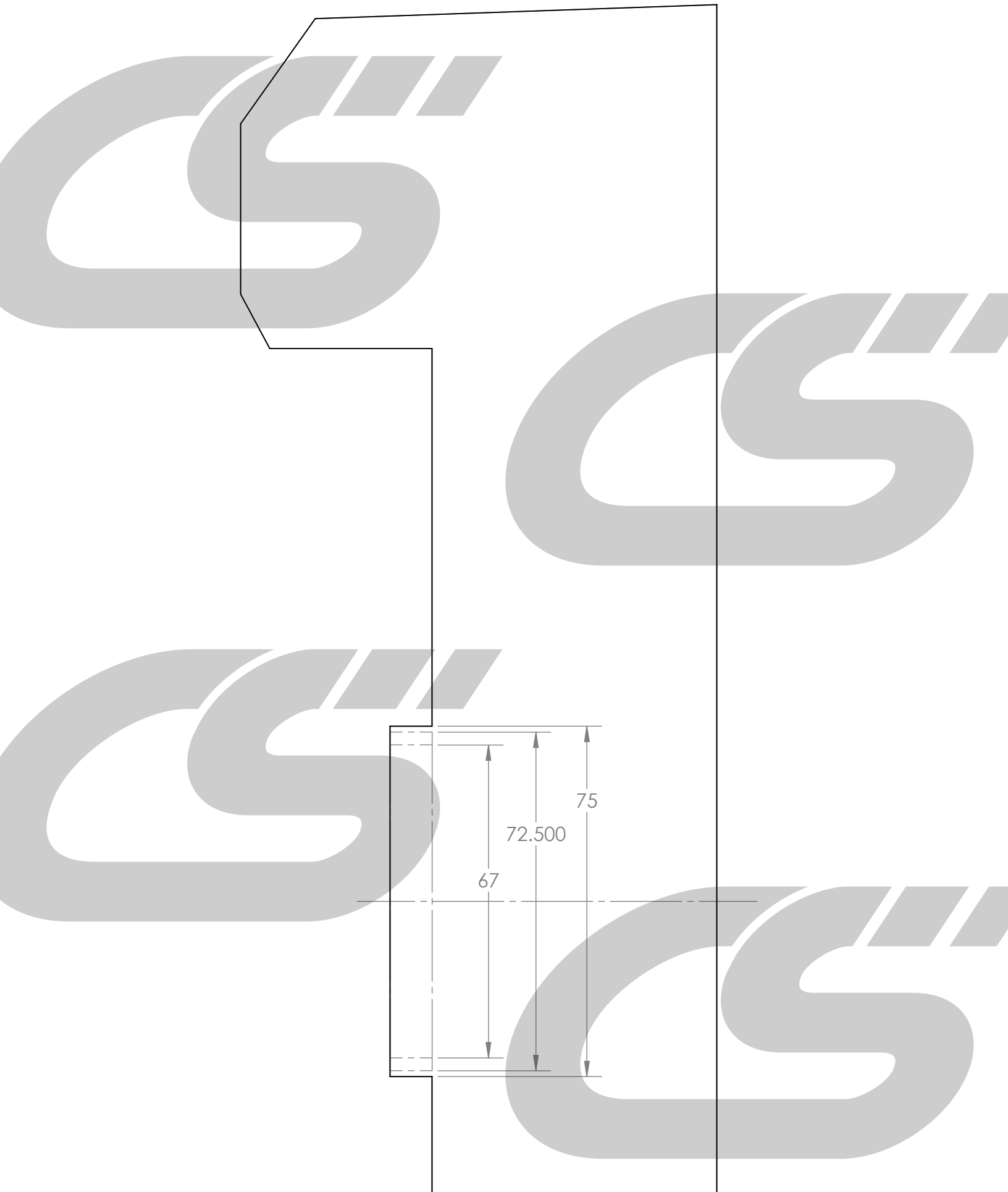

67

72.500

75