

# INSTALLATION INSTRUCTIONS

*Due to the extensive length of the install, full instructions are only available online by scanning the QR code below.*



**SCAN ME!**

## **CORKSPORT Turbo Kit 2.5L Mazda 3 & 6**

*2014-2018 Mazda 3 LHD, 2014-2017 Mazda 6 LHD  
Manual & Automatic Transmissions*

**PART #: AXM-6-566-10**

*Need Help With Your Installation? Call (360)260-CORK*



*We absolutely, positively,  
deliver - every time.*

**CORKSPORT.COM**

# BEFORE BEGINNING INSTALLATION, PLEASE SEND YOUR OEM ECU CALIBRATION TO: [turbokit@corksport.com](mailto:turbokit@corksport.com)

**CHECK OUT THE "TUNE INSTALLATION" VIDEO IN THE YOUTUBE PLAYLIST LINKED BELOW FOR  
DETAILS ON HOW TO GET YOUR OEM CALIBRATION**

**CHECK OUT THE QR CODES BELOW FOR MORE INFO!**

**VIDEO DATABASE:**



**:WEB LISTING**

**INSTALL INSTRUCTIONS:**



## **FIRST STARTUP CHECKLIST:**

- 91, 92, or 93 Octane Fuel in Tank
- Oil Pan Sealant Cured 24 Hours
- New Oil Filter & 5W-30 Oil Installed
- Coolant Refilled
- Inspected Oil & Coolant Lines for Leaks
- Provided spark plugs; gapped to 0.026" and installed
- All electrical connections plugged in (ECU, MAF, O2 Sensor, Oil Pressure, Coil Packs, Battery)
- Boost Controller Setup as Instructed
- Tune Setup as Instructed
- Double check all clamps
- Double check all vacuum/boost lines

## **MATERIALS & TIME:**

### GENERAL INFO:



Time Est:  
22-26hrs



Difficulty:  
5/5



CEL:  
Yes



Warranty:  
2-Year

### TOOLING LIST:

- 8-19mm Sockets
- 1/4" Drive Ratchet
- 3/8" Drive Ratchet
- 4" Extension
- Oxygen Sensor Socket
- 8-17mm Wrenches
- Flathead Screwdriver
- Phillips Screwdriver
- 2mm Allen Wrench
- 3mm Allen Wrench
- 5mm Allen Wrench
- 8mm Allen Wrench
- T20 Torx
- Jack Stands
- Floor Jack
- Channel Lock Pliers
- Needle Nose Pliers
- Adjustable Wrench
- Stick Magnet
- Oil Filter Wrench
- Oil Pan Removal Tool
- Plastic Razor Blades
- Razor Blades
- Plug Gapping Tool
- A Friend or two
- Liquid Libations for said Friends

### PARTS LIST:

- CorkSport Turbo & Fittings Kit
- CorkSport Modified Oil Pan
- CorkSport Intercooler & Brackets Kit
- CorkSport Battery Tray & Misc. Parts Kit
- CorkSport Intercooler Piping Kit
- CorkSport Exhaust Manifold
- CorkSport Downpipe
- CorkSport BPV
- CorkSport Boost Gauge
- Turbosmart Boost Controller Kit
- CorkSport MAF Housing
- CorkSport Dry Flow Air Filter
- XS Power Battery Kit
- CorkSport Turbo Kit Merch Pack
- Tatrix Adapter & Cable

### ADDITIONAL SUPPLIES LIST:

- Masking Tape
- 5Qt 5W-30 Dexos2 Certified Oil
- New OEM/Comparable Oil Filter
- FL-22 or Compatible Coolant
- Permatex Optimum Black Silicone
- Scrap Cardboard
- Brake/Parts Cleaner
- Oil/Fuel Safe PTFE Tape/Sealant
- Tesa Tape (or Electrical Tape)
- Zip Ties
- Solder & Seal Connectors
- Heatshrink Tubing
- Misc. Wiring

## ADVISORIES:



Due to the extensiveness of this kit, there are a number of advisories for you to be aware of. We include these to ensure you understand what to expect from your CorkSport Turbo kit. We also include them to help you understand how to keep your vehicle functioning correctly and retain the CorkSport warranty for the CS components. Full warranty information is located on the last page of this packet.



Installing a turbo kit on your vehicle will put additional stress and accelerated wear on your vehicle's systems due to the increased power output. These systems include but are not limited to: engine, transmission, clutch, & axles. By installing the kit, the owner assumes the risks & responsibility associated with the turbo kit. CorkSport is not liable for any vehicle damage that may result from turbo kit installation & use.



Before installation, please ensure your vehicle is in the best condition it can be in. Any pre-existing issues present with the engine/transmission/clutch/etc. will be worsened with the added power and torque.



We have extensively tested this kit for over 10000+ miles on an otherwise stock car with no issues. However, everyone's vehicle is different and high mileage and/or vehicles with poor service history may experience greater risk of damage.



Excess abuse (frequent redlining, burnouts, etc.) and/or improper maintenance after the turbo kit has been installed will further increase risks of damage to vehicle systems.



Allow the vehicle engine to properly warm up to operating temperature before driving the vehicle "hard" and allow the vehicle to cool/drive easy before shutting off the engine.



Increasing the peak power output will more quickly find the limit of the OEM cooling system during track/autocross driving situations. Daily driving situations are not as significantly affected.



The CorkSport turbo kit has a few advisories so that the vehicle will work correctly with the supplied OTS tune:



91, 92, or 93 Octane fuel must be used to ensure proper performance & engine health. Using lower octane gasoline and/or ethanol blended fuels greater than 10% ethanol can result in engine knock and/or other potential engine damage.



Switching to a high quality 5W-30 oil is required for added protection for the increased heat & load that comes from turbocharging a vehicle. Oil with dexos2 certification is recommended to ensure the oil can handle fuel dilution that can be common on direct injected & turbocharged vehicles. Oil change intervals at 5k miles or less.



An oil catch can is strongly recommended for long term engine health. However, if you have an existing CS or similar OCC, the naturally aspirated setup will no longer work when installing the turbocharger as it will pressurize your OCC. We have kits for sale for both upgrading an existing OCC to work with the turbo kit and a complete kit for use with the turbo kit.



New spark plugs are provided that are one step colder heat range. These must be gapped to 0.026" and installed for proper operation. Recommended to replace spark plugs every ~10k miles, with same plugs and gapped to 0.026", for optimal operation.



Advertised horsepower and peak boost levels were tested on a vehicle near sea level. Vehicles operated at excess elevation will result in lower boost & horsepower levels. Boost controller may need to be adjusted to reach advertised boost levels. See boost controller video & install instructions for details





Vehicle exhaust size will affect horsepower potential & peak boost levels. See turbo kit web listing & boost controller setup sections of installation instructions for full details.





Do not modify the wastegate preload or boost controller settings to increase boost pressure above advertised peak pressures. These values are designed to be a safe level for both the engine and fuel system. Increasing boost pressure further is likely to cause engine knock, fuel cut, and/or engine damage. See boost controller setup sections of installation instructions for full details.


## ADVISORIES (CONTINUED):


 The CorkSport turbo kit removes the OEM catalytic converter and as a result is not legal for road use in most areas. The kit is sold for off-road and racing use ONLY. Removing the catalytic converter also illuminates a check engine light.


 Installation of the CorkSport turbo kit is a very long process that can be difficult at times. Please read through all instructions to ensure you are comfortable performing the work before starting installation.


 **NOTE** Some additional supplies/components are required during the installation. Please see the additional supplies list on the previous page.

 **NOTE** If you are not confident completing basic wiring please seek assistance to complete the installation. While the connections are fairly simple, we include this warning as improperly connected wiring can cause fires.


 Because the CorkSport turbo kit utilizes the OEM ECU that is setup for a naturally aspirated engine, it lacks the control systems for 100% perfect operation with a turbocharger. We have worked extensively to optimize the tune as best as we can, however, there are certain situations where minor "surges" or "hiccups" can be felt. We will continue working to further optimize the tuning!


 **NOTE** Typically, these "hiccups" are when accelerating at lower RPM in a higher gear and/or when "lugging" the engine. We recommend downshifting to keep the vehicle at 3500+ RPM when attempting to pass another vehicle, merge onto the highway, and/or travel up a steep incline. It can also help to disable cruise control for hills on the highway.


 For customers outside the continental USA, we are not able to ship the smaller battery required for turbo. Similar batteries can be purchased from manufacturers in your area to save on cost & make shipping possible. The supplied battery box is designed around an XS Power D925 battery that is 165mmx176mmx125mm (6.5"x6.93"x4.92") in size.

 **NOTE** If you plan to dyno your car after install, please note that power numbers from one dyno to another will vary. Test results shown on our website are from a Dyno Dynamics unit calibrated to approximately match a DynoJet dyno. Some dynos may read a lower peak power number, however, change from stock is a more important metric. Our testing showed an increase of ~110-120WHP from 100% stock to turbo kit with 80mm exhaust.


 Clutch System Consideration: It is common to find that the OEM clutch assembly cannot support the added power of a turbo kit (or a turbo upgrade for vehicles that came equipped for example). In our testing we have found that the OEM clutch assembly may or may not support the increased power output that the CorkSport turbo kit produces.

 **NOTE** OEM clutches in good working condition and minimal wear can support the increased power both in daily driven street applications and severe track abuse. However, OEM clutches that are excessively worn and/or abused may or may not support the increased power. The result of this will be a slipping clutch during attempted hard acceleration.

 **NOTE** Replacing the OEM dual mass flywheel with a lighter weight single mass flywheel may result in more noticeable gear noise and/or NVH (noise, vibration, harshness) from the transmission. In our testing we have found the additional noise to be minimal. However, a single mass flywheel will aid in faster revving and response by the engine.

 **NOTE** Automatic Transmission Note: In our testing we have not yet found issues with the automatic transmission handling the increased horsepower and torque. For frequent racing use, we recommend adding a transmission cooler and/or larger radiator for added protection.

 Installing the CorkSport turbo kit on any vehicle other than the approved vehicle list (2014-2018 Mazda 3 LHD, 2014-2017 Mazda 6 LHD at time of writing) will likely cause issues with fitment and/or functionality

 CorkSport OTS ECU Calibration will be provided within 3 business days of received OEM ECU Calibration from you the customer, please plan accordingly.

 An upgraded performance RMM (rear motor mount) is strongly recommended for installation and operation of the CorkSport Turbo Kit. The OEM RMM is too soft and allow too much engine movement for the increased power of the turbo kit.

## NON-TRANSFERRABLE WARRANTY PAGE:

By installing and operating the CorkSport Turbo Kit, you are also accepting these terms.

- NOTE** CorkSport provides from the date of purchase to the original purchaser, a
- 24-month limited warranty on all CorkSport brand parts except noted below (for hard parts replacement and/or repair only)
  - 12-month limited warranty on CorkSport brand turbocharger assembly (AXM-6-566-11)
  - Manufacturer's limited warranty for non-CorkSport brand parts (Battery, Boost Controller System, Split Second, Tactrix & Cable, Etc)
  - No returns accepted all sales final
- !** This limited warranty covers manufacturing defects in material and workmanship only. At the time of service, the owner will need to be able to provide evidence of date and place of purchase.
- !** CorkSport does not cover damage or failure caused by abuse, misuse, faulty installation, improper maintenance, or any repairs not carried out by CorkSport.
- !** There will be no obligation or liability on the part of CorkSport for consequential damages arising from the use of the product or any indirect damages with respect to loss of property, revenue, or cost for removal, installation, or re-installation.
- NOTE** For warranty service the product must be reported to CorkSport to receive a unique RA# (return authorization number) and at that time you will be advised of where to send the faulty product.
- NOTE** All shipping charges for returns should be pre-paid. If the requested repairs or service are within the terms of this warranty then the item will be returned to you on completion without any charge. The unit must be in its original package with any original accessories. CorkSport will not be responsible for any loss or damage to additional items, which are sent with returned product.
- NOTE** If the product is not covered under the terms of this warranty, CorkSport will advise you of the costs to carry out any repairs necessary and the unit will be shipped to you on receipt of payment for the work including the return freight charges.
- NOTE** Please allow 2 to 4 weeks for return of your product. We try to ensure we carry out warranty repairs within five working days. We cannot be held responsible for delays in shipping.
- !** Installation Process: Extensive time and effort was done by CorkSport to provide detailed color step-by-step installation instructions; both in written and video form. Failure to use the provided installation instructions may result in incorrect installation. If it is determined that incorrect installation was the cause of a warranty claim, said claim will not be honored. This stands for both DIY installation and professional installation by a "shop/mechanic".
- !** Operation of the CorkSport Turbo Kit: To maintain valid warranty support by CorkSport Performance LLC, the use and operation of the turbo kit must follow the requirements below:
- NOTE** Provided OTS ECU calibration must be used or a custom calibration can be requested by DramaTuned LLC ONLY. Use of any other tune provided by an entity other than CorkSport or DramaTuned will void warranty.
- NOTE** Fuel used must be USDM (or equivalent) gasoline Rated at 91, 92, or 93 octane and up to 10% ethanol blended. Use of lower octane gasoline, higher % blended ethanol fuels and methanol/secondary fueling will void warranty.
- NOTE** Not using and/or excessively adjusting the provided boost controller and mechanical wastegate to exceed the boost limit of 9.5psi will void warranty AND potentially cause significant engine damage.
- NOTE** Provided spark plugs (NGK Part# DILKAR8A8) and proper gap of 0.026" must be completed and used or warranty will be voided.
- NOTE** The provided BPV (By-Pass Valve) or a similar full-recirc BVP must be used for proper operation. Use of a non-recirculating BOV (Blow Off Valve) and/or a BPV Block Off Plate may harm the Turbo and Engine. Failure to use the proper BPV will void warranty.
- !** Vehicle Applications: All research, development and testing have been completed on 2014-2018 Mazda 3 LHD and 2014-2017 Mazda 6 LHD vehicles (manual and automatic transmissions). Operation on different but similar models has not been tested and validated. Installation and use on vehicles other than vehicles listed above will void warranty.
- NOTE** With that being said, CorkSport is actively working on this development and hopes to support other similar vehicle applications in the future, but proper testing and validation must be completed first.



# CORKSPORT Turbo Kit 2.5L Mazda 3 & 6

2014-2018 Mazda 3 LHD, 2014-2017 Mazda 6 LHD  
Manual and Automatic Transmission



## PRODUCT DESCRIPTION:

The long awaited turbo kit for the 3<sup>rd</sup> GENS is finally here! The CorkSport Turbo Kit supplies just about everything you need to drastically "boost" the power of your stock GEN Mazda 3 & 6. Depending on your exhaust setup, this kit adds up to ~9.5psi of peak boost to really wake up your Mazda and surprise some people between the lights. This kit is extremely extensive but can be installed with fairly basic tools in just about anyone's garage!

Please let us know your feedback by submitting a review at:  
<https://corksport.com/2014-2018-mazda-3-2.5l-manual-turbo-kit.html>

## PRE-INSTALLATION NOTES:



Verify that the car is on a level surface before proceeding. Use appropriate load rated jack stands to support the vehicle.



These instructions were written for reference only and the use of a factory service manual is recommended.



How our instructions work: To best cover all of our customers experience levels, we have included a table of contents/order of operations along with step-by-step instructions.



Make sure your vehicle is cooled down prior to starting installation. If you are going to work on your car within an hour of having driven it, use a fan to cool off the car.



These instructions were written using a 2018 Mazda 3 with Manual Transmission. Earlier years and trim levels will be similar. Notes are added where needed for Mazda 6 and Automatic vehicle fitment.

## MATERIALS & TIME:

### GENERAL INFO:



Time Est:  
22-26hrs



Difficulty:  
5/5



CEL:  
Yes



Warranty:  
2-Year

### TOOLING LIST:

- 8-19mm Sockets
- 1/4" Drive Ratchet
- 3/8" Drive Ratchet
- 4" Extension
- Oxygen Sensor Socket
- 8-17mm Wrenches
- Flathead Screwdriver
- Phillips Screwdriver
- 2mm Allen Wrench
- 3mm Allen Wrench
- 5mm Allen Wrench
- 8mm Allen Wrench
- T20 Torx
- Jack Stands
- Floor Jack
- Channel Lock Pliers
- Needle Nose Pliers
- Adjustable Wrench
- Stick Magnet
- Oil Filter Wrench
- Oil Pan Removal Tool
- Plastic Razor Blades
- Razor Blades
- Plug Gapping Tool
- A Friend

### PARTS LIST:





- CorkSport Turbo & Fittings Kit
- CorkSport Modified Oil Pan
- CorkSport Intercooler & Brackets Kit
- CorkSport Battery Tray & Misc. Parts Kit
- CorkSport Intercooler Piping Kit
- CorkSport Exhaust Manifold
- CorkSport Downpipe
- CorkSport BPV
- CorkSport Boost Gauge
- Turbosmart Boost Controller Kit
- CorkSport MAF Housing
- CorkSport Dry Flow Air Filter
- XS Power Battery Kit (USA Only)
- CorkSport Turbo Kit Merch Pack
- Tactrix Adapter & Cable

### SUPPLIES LIST:

- Masking Tape
- 5Qts 5W-30 Dexos2 Certified Oil
- New OEM Oil Filter
- FL-22 or Compatible Coolant
- Permatex Optimum Black Silicone
- Scrap Cardboard
- Brake & Parts Cleaner
- Oil/Fuel Safe PTFE Tape/Sealant
- Tesa Tape (or Electrical Tape)
- Zip Ties
- Solder & Seal Connectors
- Heatshrink Tubing
- Wiring

# ORDER OF OPERATIONS & TABLE OF CONTENTS:

---

 <b>HARDWARE GUIDE</b>	Pg. 9-13
 <b>OEM PARTS REMOVAL</b>	
<u><a href="#">Section 1: Removing the OEM Hood and Cowl</a></u>	Pg. 14-19
<u><a href="#">Section 2: Removing the OEM Header Heatshields</a></u>	Pg. 19-21
<u><a href="#">Section 3: Removing the OEM Intake, ECU, &amp; Battery Tray</a></u>	Pg. 22-25
<u><a href="#">Section 4: Removing the OEM Front Bumper &amp; Undertrays</a></u>	Pg. 26-33
<u><a href="#">Section 5: Removing the OEM Header</a></u>	Pg. 34-39
<u><a href="#">Section 6: Removing the OEM Oil Pan</a></u>	Pg. 40-43
 <b>CORKSPORT TURBO KIT INSTALLATION</b>	
<u><a href="#">Section 7: Preparing &amp; Installing the CS Modified Oil Pan</a></u>	Pg. 43-46
<u><a href="#">Section 8: Coolant and Oil Feed Line Preparation</a></u>	Pg. 47-49
<u><a href="#">Section 9: Turbocharger Pre-Install Setup</a></u>	Pg. 50-54
<u><a href="#">Section 10: Turbocharger Installation &amp; Plumbing</a></u>	Pg. 55-60
<u><a href="#">Section 11: Downpipe Installation</a></u>	Pg. 60-61
<u><a href="#">Section 12: Hot Side Intercooler Piping Installation</a></u>	Pg. 62-69
<u><a href="#">Section 13: Intercooler Installation</a></u>	Pg. 70-73
<u><a href="#">Section 14: Cold Side Intercooler Piping Installation</a></u>	Pg. 74-76
<u><a href="#">Section 15: Wiring Harness Cleanup &amp; ECU Relocation</a></u>	Pg. 77-81
<u><a href="#">Section 16: Miscellaneous Plumbing Installation</a></u>	Pg. 81-86
<u><a href="#">Section 17: Routing Components Through the Firewall</a></u>	Pg. 87-89
<u><a href="#">Section 18: Negative Terminal Harness Modification</a></u>	Pg. 89-90
<u><a href="#">Section 19: Intake Assembly &amp; Installation</a></u>	Pg. 90-94
<u><a href="#">Section 20: Battery Tray &amp; Battery Installation</a></u>	Pg. 95-97
 <b>FINAL PLUMBING, WIRING, &amp; REASSEMBLY</b>	
<u><a href="#">Section 21: EBCS Mounting &amp; Line Routing</a></u>	Pg. 97-100
<u><a href="#">Section 22: Spark Plug Replacement</a></u>	Pg. 100-101
<u><a href="#">Section 23: O2 Sensor &amp; Firewall Heatshield Reinstall</a></u>	Pg. 101-102
<u><a href="#">Section 24: Vehicle Wiring: Boost Gauge</a></u>	Pg. 103-105
<u><a href="#">Section 25: Vehicle Wiring: Tach Adapter</a></u>	Pg. 106
<u><a href="#">Section 26: Vehicle Wiring: Turbosmart Boost Controller</a></u>	Pg. 107-108
<u><a href="#">Section 27: Fluids &amp; Final Checks</a></u>	Pg. 108
<u><a href="#">Section 28: Turbosmart Boost Controller Setup for 80mm Exhaust</a></u>	Pg. 109
<u><a href="#">Section 29: Turbosmart Boost Controller Setup for 60.5mm Exhaust</a></u>	Pg. 110
<u><a href="#">Section 30: Turbosmart Boost Controller Setup for OEM Exhaust</a></u>	Pg. 111
<u><a href="#">Section 31: Tuning Software, Tactrix, &amp; Tune Setup</a></u>	Pg. 112
<u><a href="#">Section 32: First Startup &amp; Reassembly</a></u>	Pg. 113
<u><a href="#">Section 33: Wastegate Actuator Adjustments</a></u>	Pg. 114-119



## HARDWARE GUIDE:

- NOTE** This section of the instructions outlines all the hardware present in your kit. Use it as a guide during later steps to help determine what hardware is being referenced.
- NOTE** The boxes within your turbo kit package will have a barcode on one end. This part number is referenced below in the hardware guide. One barcode is shown to the right.
- NOTE** Only the boxes that include hardware are shown in this section.

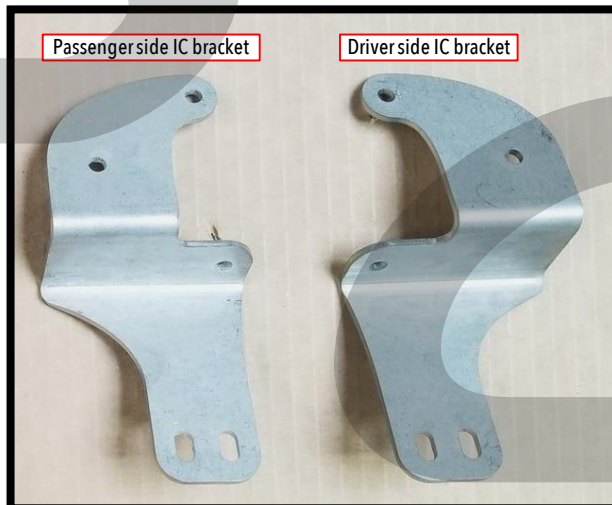


### AXM-6-566-A3 Box: Intercooler & Hardware

This box contains the intercooler and a smaller box that contains hardware used to mount the intercooler. All hardware for the intercooler is the same. Brackets and hardware shown below.



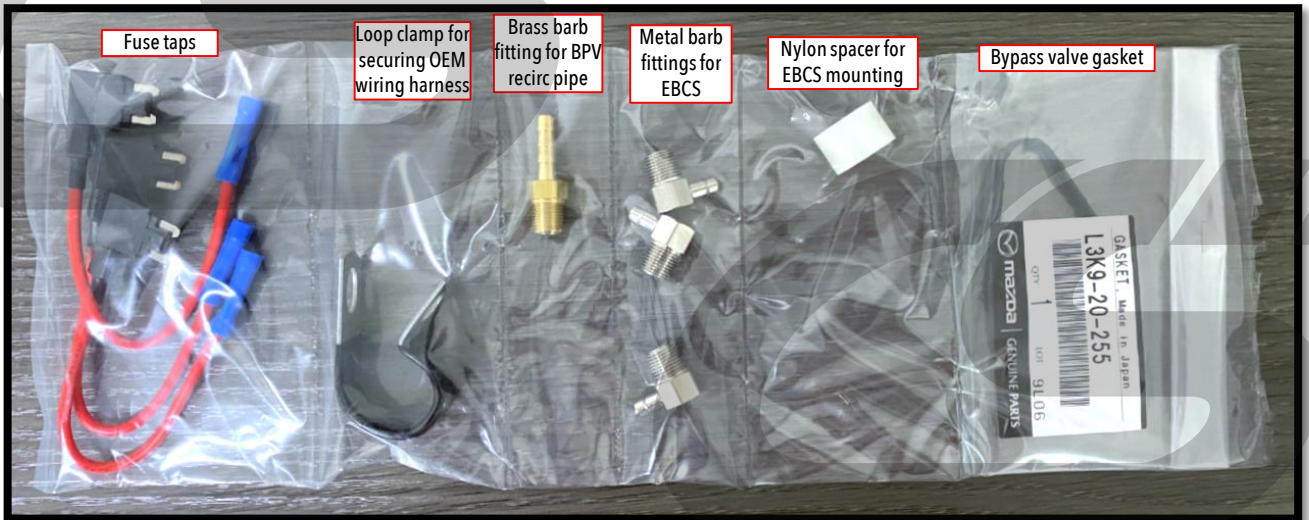
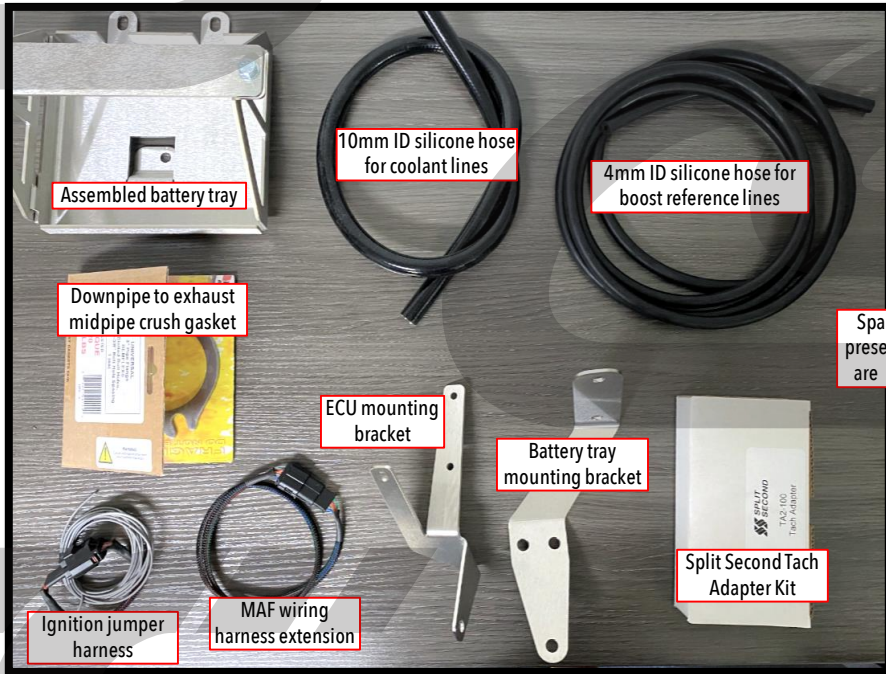
An extra bolt & nut is included in this package.



## HARDWARE GUIDE:

### AXM-6-566-A4 Box: Miscellaneous Components & Hardware

This box contains some miscellaneous small parts as well as hardware for many components. The top image shows the large components in the box. The images at the bottom of the page and on the next page show the hardware inside the smaller white box.



**HARDWARE GUIDE:**

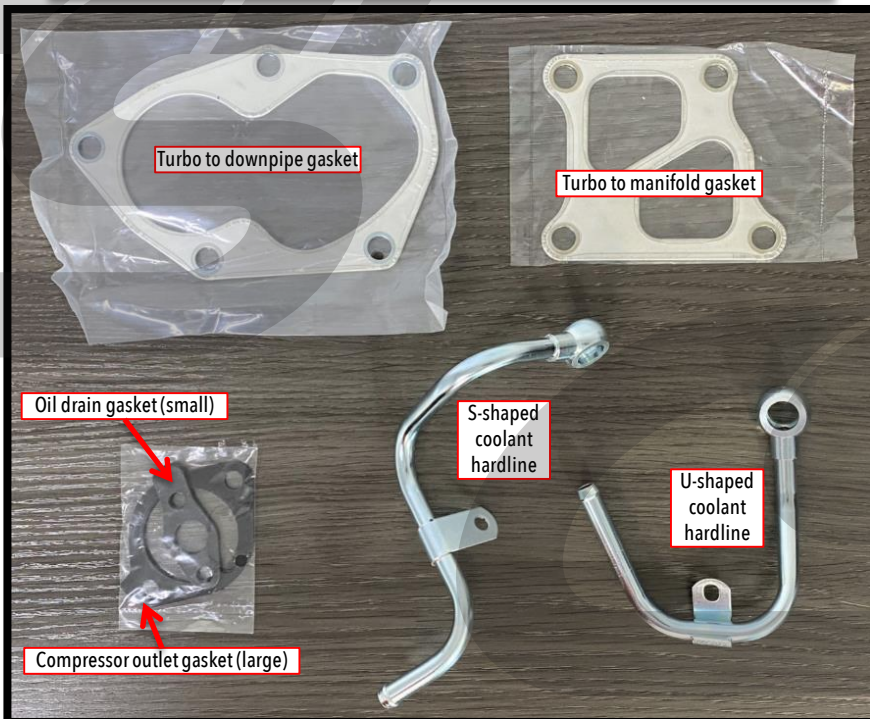
**AXM-6-566-A4 Box: Miscellaneous Components & Hardware (continued)**



## **HARDWARE GUIDE:**

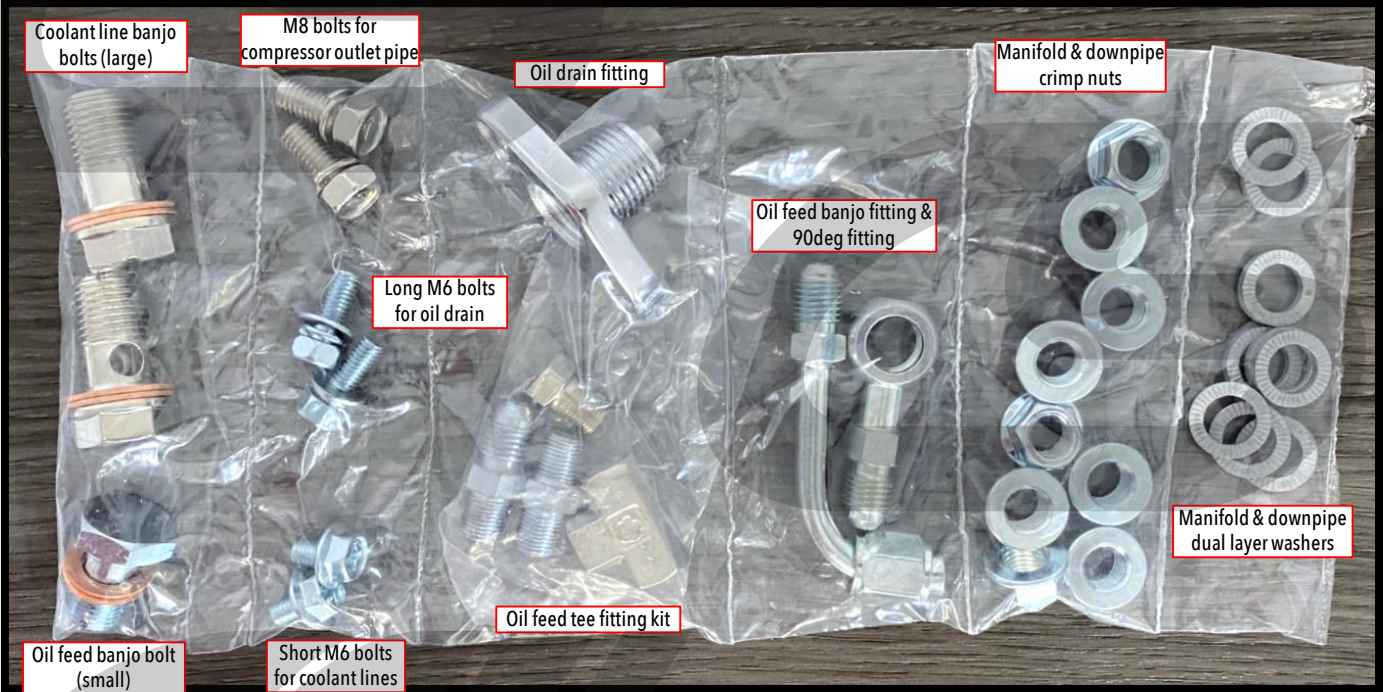
### AXM-6-566-11 Box: Turbocharger Components & Hardware

This box ships separately and contains the turbocharger and all the hardware/components needed for turbo installation. We do not highlight the turbocharger in this section.

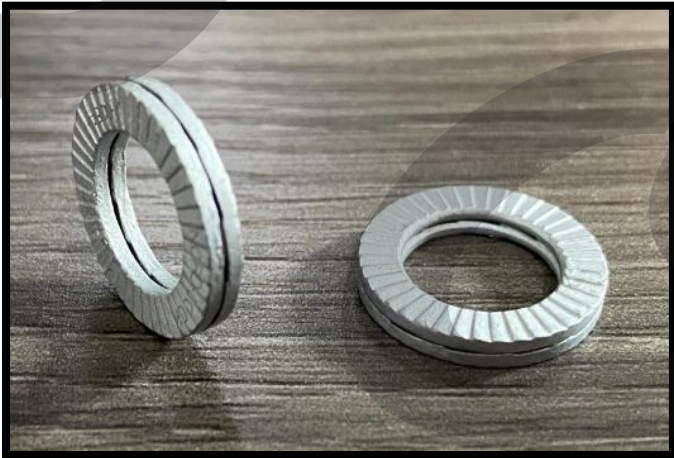


## HARDWARE GUIDE:

AXM-6-566-11 Box: Turbocharger Components & Hardware (continued)



**NOTE** The washers used when connecting the turbo to the manifold and the downpipe to the turbo are a special "dual layer" design. **DO NOT** separate the layers. They should appear and be installed as shown below.



## DETAILED INSTRUCTIONS:

### 1. Removing the OEM Hood and Cowl



Verify that the car is on a level surface before proceeding. Use appropriate load rated hydraulic jack and jack stands to support the vehicle.

- a) Engage the parking brake and raise the front of the vehicle with a hydraulic floor jack, then support with jack stands.



Please refer to the owners manual for proper jack stand location.



The rear of the vehicle does not need to be lifted as you will only be accessing the front half.



Removing the hood is optional however we strongly recommend doing so for easier access & visibility throughout the install.

- b) Open the hood of the vehicle and locate the four 12mm bolts (two on each side) that attach the hood to the hood hinges in the rear corners. Two shown circled in red in Figure 1a.



The hood will come off immediately upon removal of these bolts. Support each side of the hood as the bolts are removed.

- c) With a friends help on the other side, remove the four 12mm bolts. Then remove the hood from the vehicle.
- d) Place your hood out of the way, safe from any damage.
- e) Remove the plastic covers from the windshield wipers. They pull straight off with a little effort. Shown circled in red in Figure 1b.



Figure 1a



Figure 1b

## DETAILED INSTRUCTIONS:

### 1. Removing the OEM Hood and Cowl (continued)

- f) Remove the two 14mm nuts from the windshield wipers. **Circled in red in Figure 1c.**
- g) Remove the windshield wipers by pulling straight away from the windshield. They should come free with a small amount of force.
- h) Remove the 5 push clips from the plastic portion of the cowl. Shown **circled in red in Figure 1d.**



Figure 1c

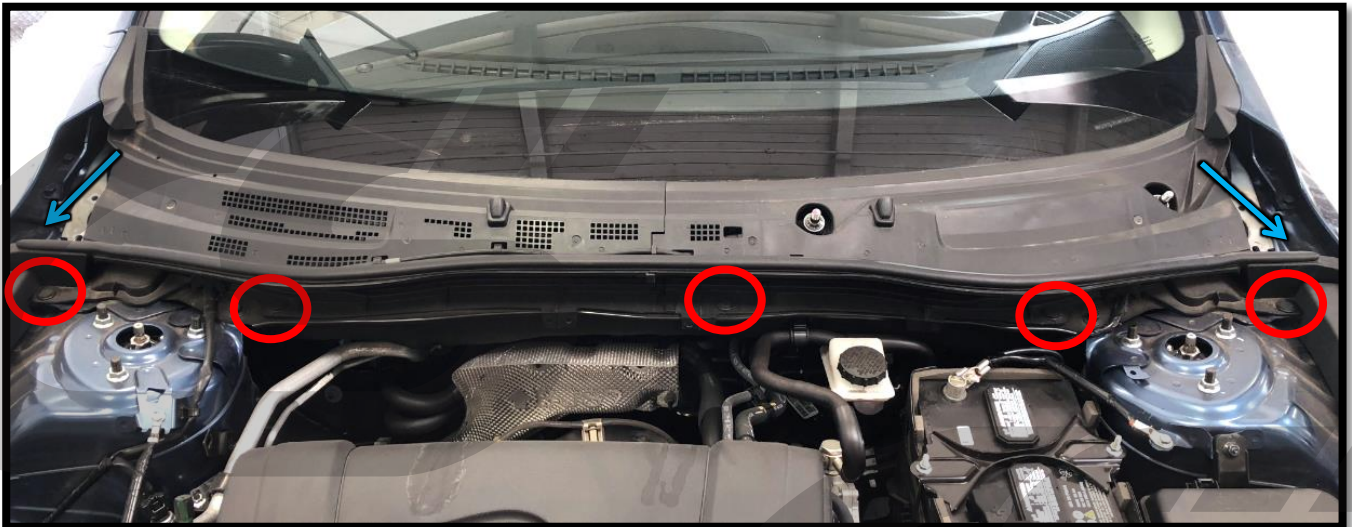


Figure 1d

- i) Look into the corners of the cowl and locate the blue retainers that keep the rubber ends of the cowl in place. Look in the areas shown with **blue arrows in Figure 1d.** Also **circled in red in Figure 1e** on the next page.

## DETAILED INSTRUCTIONS:

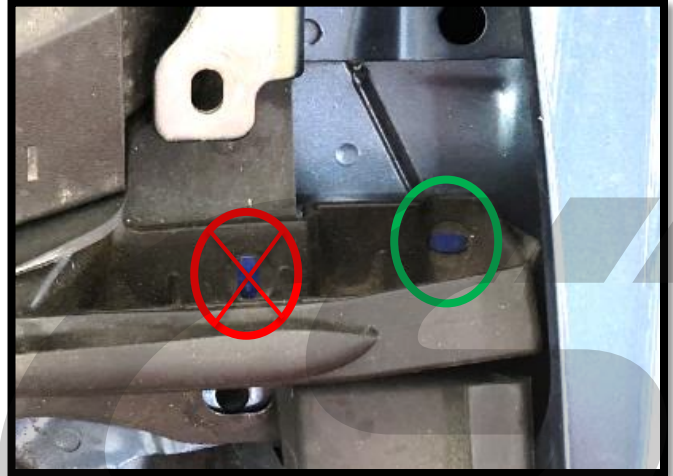
### 1. Removing the OEM Hood and Cowl (continued)

- j) Pull and stretch the rubber slightly to fit the blue retainer through the holes in the rubber. This will allow the rubber to come free from the retainers. There are two retainers on each side, only the outermost one needs to be removed from each side. Shown circled in green in **Figure 1e**.
- k) Disconnect the windshield washer line from the passenger side of the cowl. It is a rubber line with a connection in the center that can be pulled apart with some effort. Shown with red markings in **Figure 1f**.



Secure the line coming from the fender to prevent it from falling down into the fender.

- l) Flip up the hood hinges to get them out of the way.
- m) Pull down and out to unhook the cowl from the windshield and remove the plastic section of the cowl from the vehicle.



**Figure 1e**



**Figure 1f**



**Figure 1g**



**DETAILED INSTRUCTIONS:****1. Removing the OEM Hood and Cowl (continued)**

n) Disconnect the electrical connector from the wiper motor. Push in the small tab on the underside and pull outward. Connector shown **circled in red** in **Figure 1h**.

o) Remove the two 10mm bolts that attach the wiper motor to the vehicle. Shown **circled in green** in **Figure 1h**.

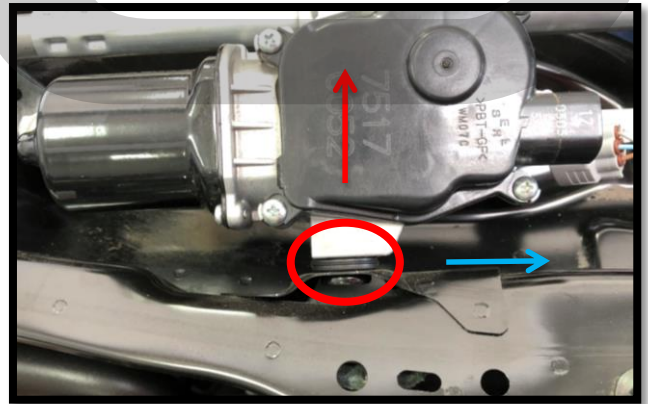
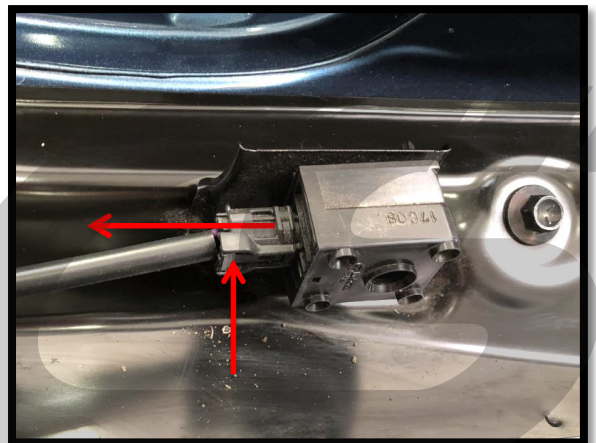


Be very cautious when performing the next step as you could damage your windshield if not careful. If needed, place a towel on the edge of the windshield.

p) Remove the wiper motor from the vehicle. It is secured with a stud in rubber grommet. It must be pulled free toward the windshield before it can then be removed from the vehicle. Shown with **red markings** in **Figure 1i**.

q) **MAZDA 6 VEHICLES** must instead move the wiper motor assembly to the right to remove. This is shown with **blue arrow** in **Figure 1i**.

q) Disconnect the electrical connector from the sensor located near the center of the cowl. Push in the tab on the front side and pull the connector free. Shown with **red arrows** in **Figure 1j**.

**Figure 1h****Figure 1i****Figure 1j**

## **DETAILED INSTRUCTIONS:**

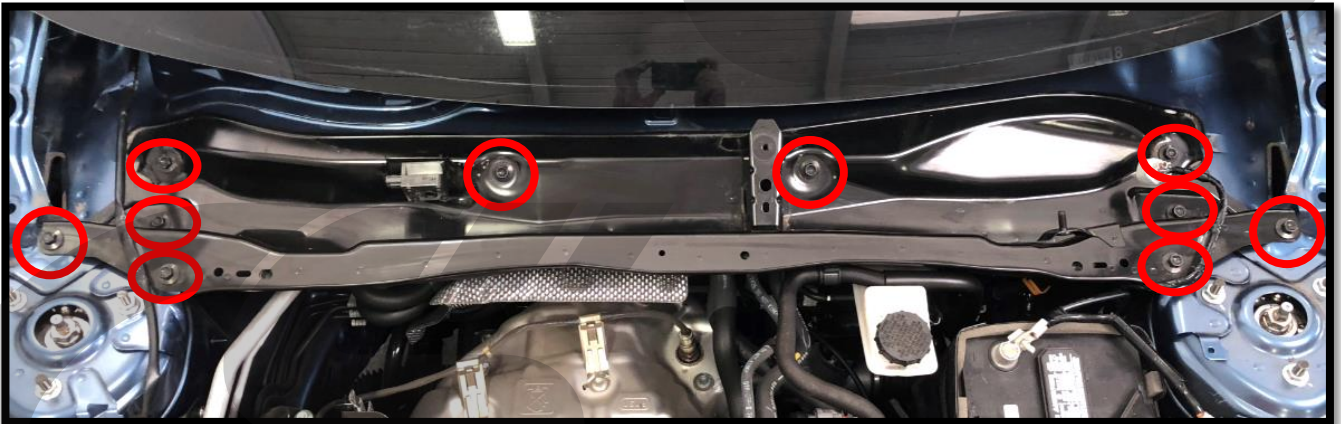
### **1. Removing the OEM Hood and Cowl (continued)**

- r) Unclip the hose from the front edge of the cowl. Use a flathead screwdriver to pry the retaining clip open as shown in **Figure 1k**. Then move this hose out of the way.



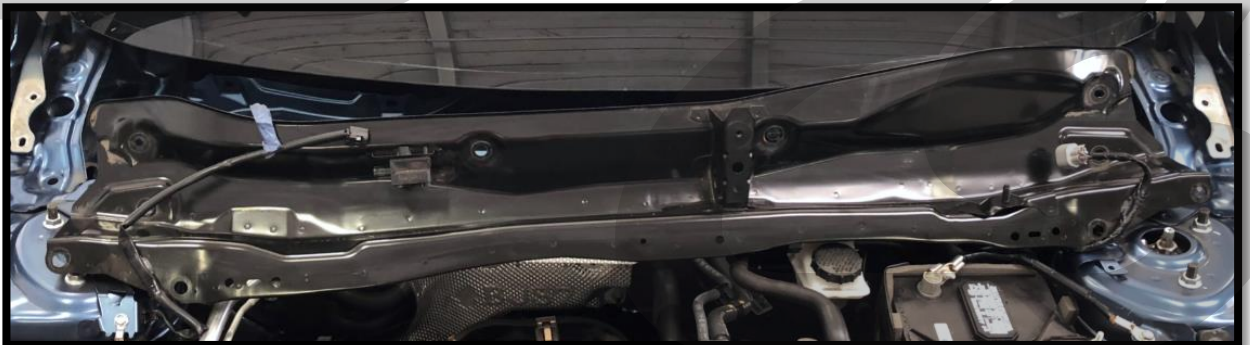
**Figure 1k**

- s) Remove the ten 12mm bolts that connect the metal portion of the cowl to the vehicle. Shown **circled in red** in **Figure 1l**.



**Figure 1l**

- t) Lift up on the cowl to gain access to the underside as shown in **Figure 1m**.

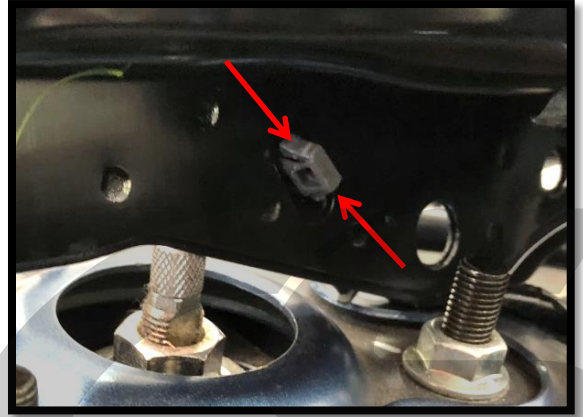


**Figure 1m**

## DETAILED INSTRUCTIONS:

### 1. Removing the OEM Hood and Cowl (continued)

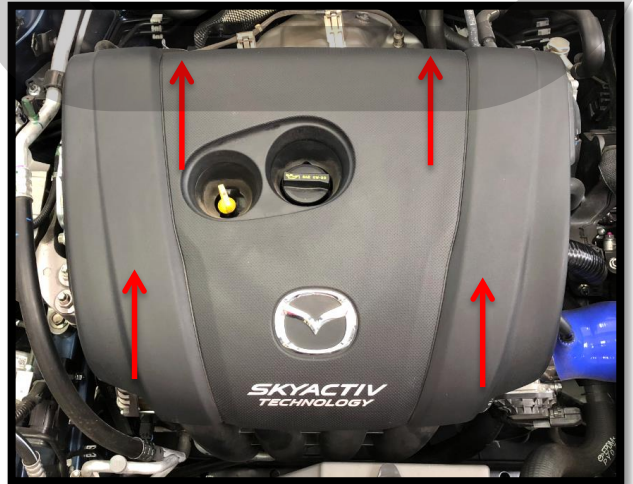
- u) Unclip the wiring harnesses from cowl, there is one clip located on each end. Access the clips from the underside of the cowl and use pliers to squeeze the clips and free the wiring. Driver's side shown in **Figure 1n**.
- v) Remove the metal portion of the cowl from the vehicle.



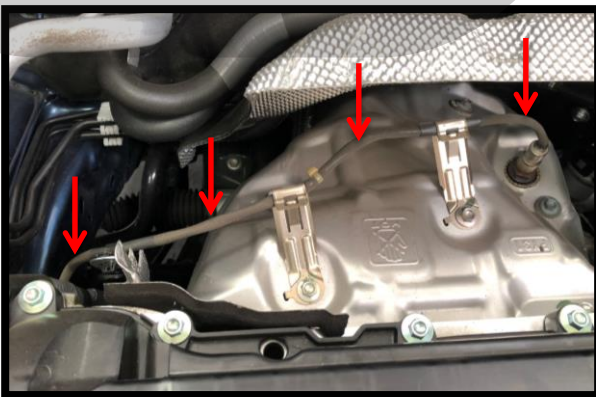
**Figure 1n**

### 2. Removing the OEM Header Heatshields

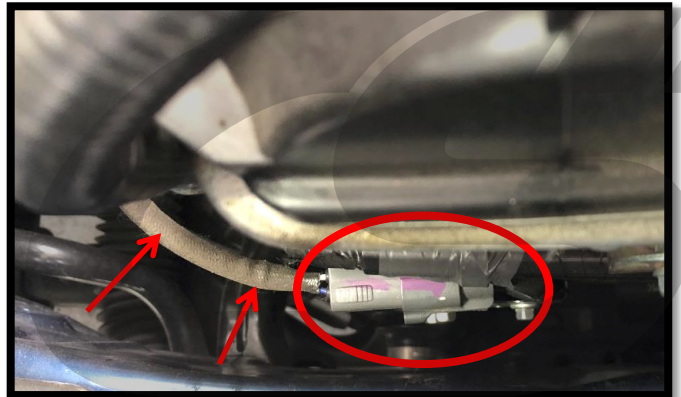
- a) Begin by removing the engine cover. Pull straight upwards and it will pop free from its four rubber mounts. Shown in **Figure 2a**.
- b) Locate the Oxygen (O2) sensor on the top of the OEM header. Trace the wiring to where it meets the engine block. Shown in **Figure 2b and Figure 2c** with the red arrows.
- c) Unplug the O2 sensor wiring. Shown in **Figure 2c**.



**Figure 2a**



**Figure 2b**

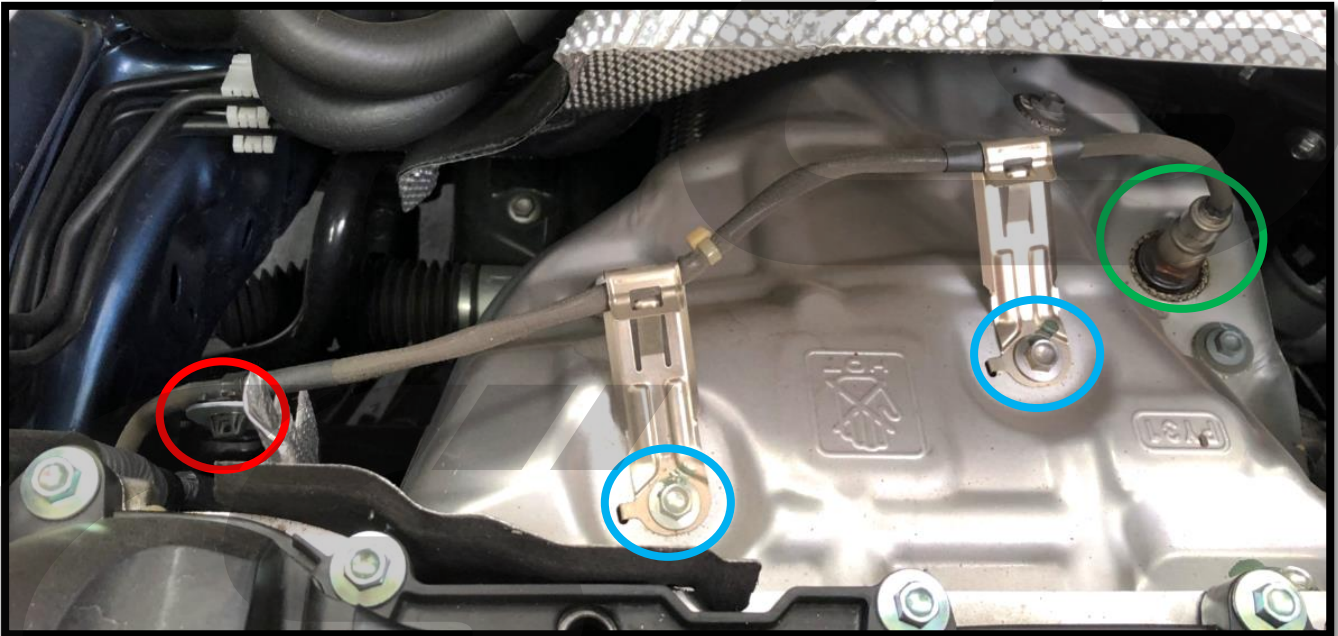


**Figure 2c**

## **DETAILED INSTRUCTIONS:**

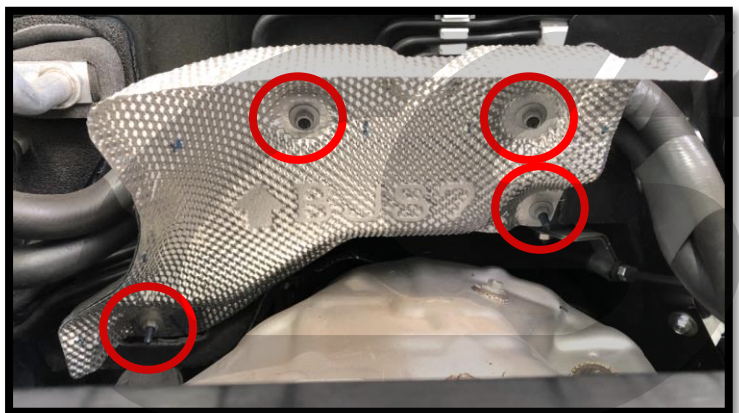
### **2. Removing the OEM Header Heatshields (continued)**

- d) Remove the plastic wiring clip that secures the O2 sensor wiring to the engine block. Show **circled in red** in **Figure 2d**.
- e) Remove the two 10mm bolts that secure the O2 sensor wiring to the OEM header. Shown **circled in blue** in **Figure 2d**.
- f) Remove the Oxygen sensor from the OEM header using an O2 sensor socket. Shown **circled in green** in **Figure 2d**.



**Figure 2d**

- g) Remove the four 10mm nuts that attach the upper heatshield to the firewall. Then remove this heatshield. Nuts shown **circled in red** in **Figure 2e**.

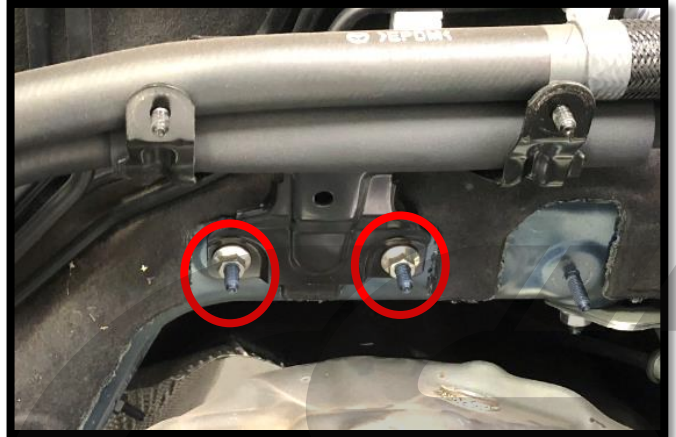


**Figure 2e**

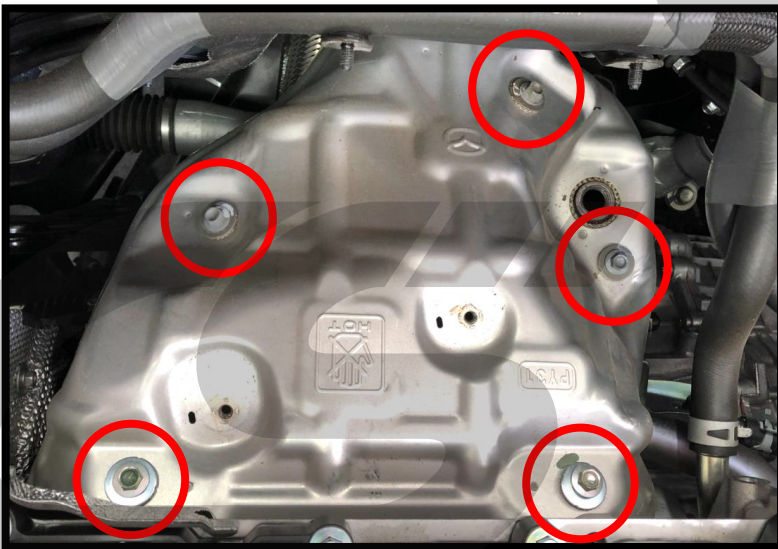
## **DETAILED INSTRUCTIONS:**

### **2. Removing the OEM Header Heatshields (continued)**

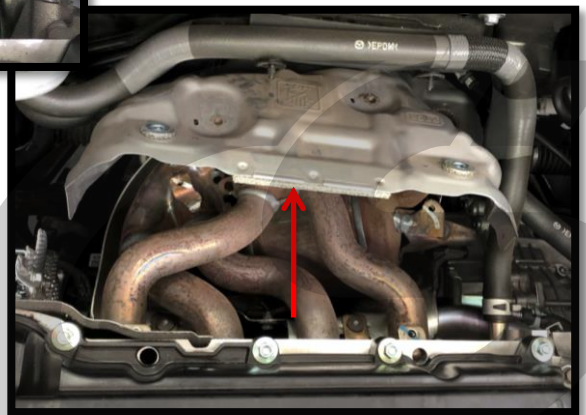
- h) Remove the heater core hose support bracket by removing the two 10mm nuts. Shown **circled in red** in **Figure 2f**.
- i) Loosen the upper manifold heatshield by removing the five 10mm bolts. Shown **circled in red** in **Figure 2g**.
- j) Slide the heatshield toward the rear of the car to expose the OEM header and engine mounting flange. Shown in **Figure 2h**.



**Figure 2f**



**Figure 2g**



**Figure 2h**

## DETAILED INSTRUCTIONS:

### 3. Removing the OEM Intake, ECU, & Battery Tray

- a) Disconnect the negative terminal of the battery with a 10mm wrench and move it out of the way.



If you have a short ram intake already installed, your removal process may be different. Refer to your SRI install instructions for help if needed.

- b) Unplug the MAF sensor connector and remove the clip that secures the MAF wiring to the OEM airbox. MAF shown **circled in red** and clip shown with **red arrow** in **Figure 3a**.
- c) Loosen the hose clamp that connects the OEM intake to the throttle body with a 10mm socket and ratchet. Shown **circled in blue** in **Figure 3a**.
- d) Remove the two 10mm bolts that attach the OEM air duct to the core support. Shown **circled in green** in **Figure 3a**.
- e) Trace the vent hose from the OEM intake back to the valve cover. Shown with **yellow arrows** in **Figure 3a** and **Figure 3b** on the next page.

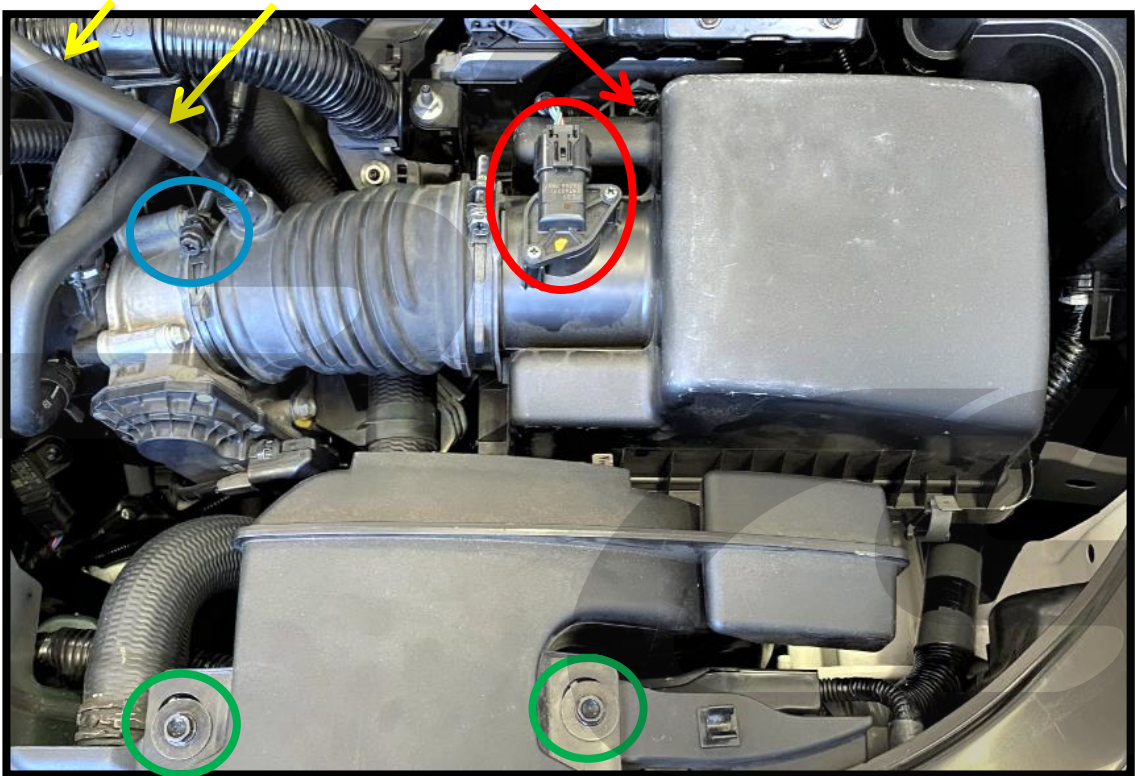
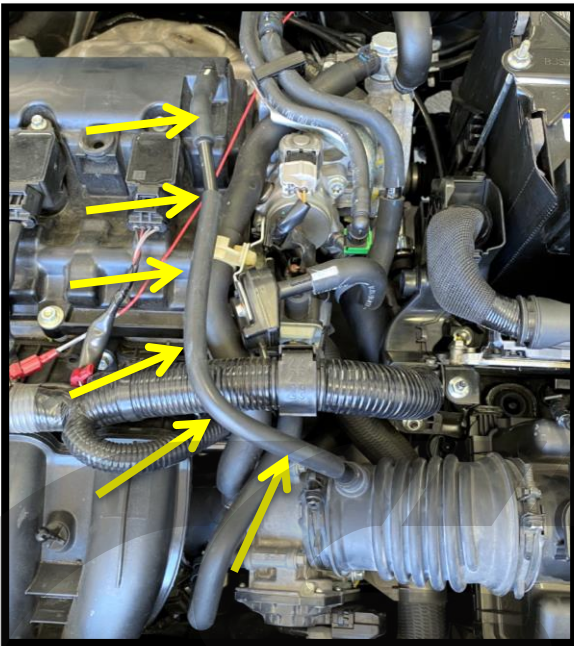


Figure 3a

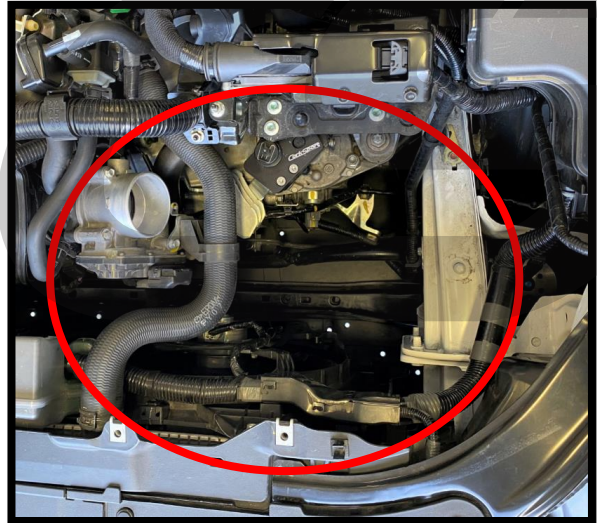
## DETAILED INSTRUCTIONS:

### 3. Removing the OEM Intake, ECU, & Battery Tray (continued)

- f) Disconnect the vent hose from the valve cover. It will pull free with a little effort. Shown with yellow arrows in **Figure 3b**.
- g) Once all components disconnected, the OEM intake and airbox can be removed by pulling straight upwards. There are three rubber grommets the airbox will need to "pop" free from. Shown removed in **Figure 3c**.

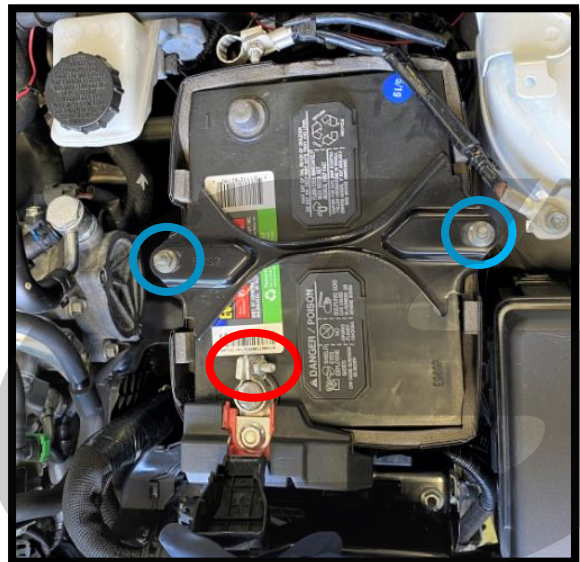


**Figure 3b**



**Figure 3c**

- h) Disconnect the positive terminal of the battery with a 10mm wrench. Shown circled in red in **Figure 3d**.
- i) Loosen the battery tie down nuts with a 10mm deep socket and ratchet. Shown circled in blue in **Figure 3d**.
- j) Remove the battery tie down bracket.
- k) The battery can then be removed from the vehicle.

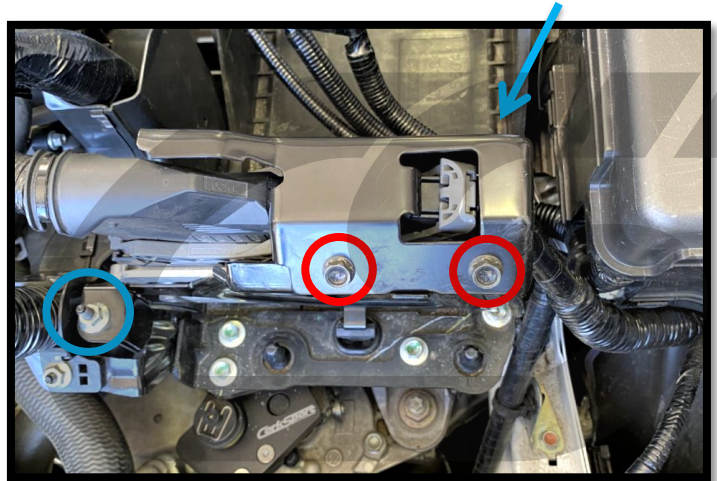


**Figure 3d**

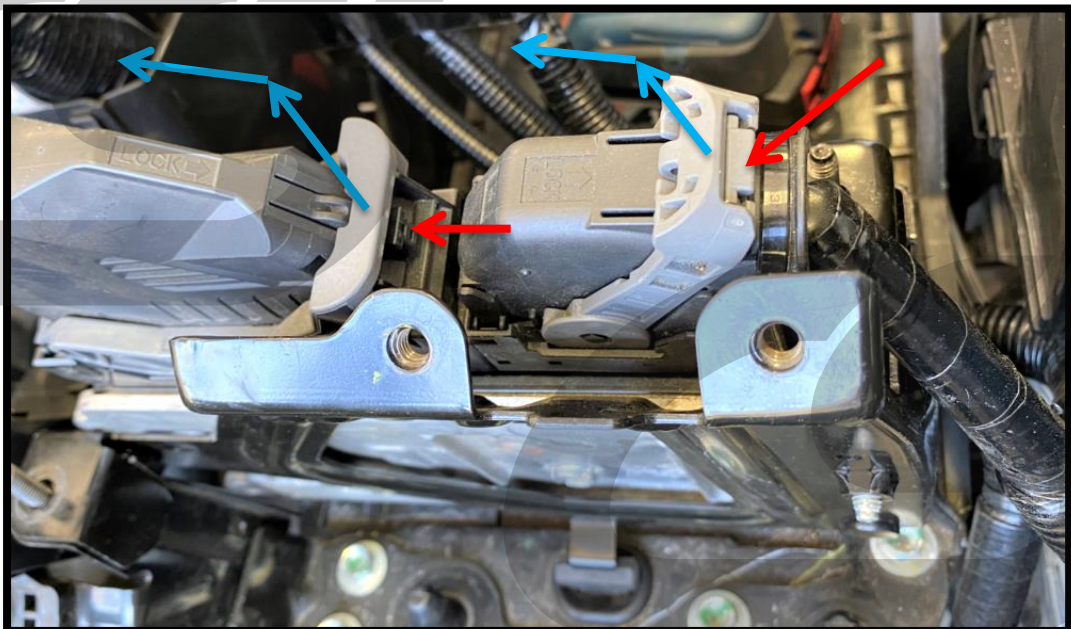
## **DETAILED INSTRUCTIONS:**

### **3. Removing the OEM Intake, ECU, & Battery Tray (continued)**

- l) Remove the two 10mm bolts holding the ECU plug cover plate to the ECU mount. Then remove the cover plate. Bolts shown circled in red in **Figure 10e**.
- m) Remove the two 10mm nuts holding the ECU bracket to the battery tray. **Shown in blue** in **Figure 10e**.
- n) Disconnect the ECU plugs. Each plug has a small button that can be pushed in, as shown with **red arrows** in **Figure 3f**. Then the gray lever is moved gently in the direction shown with **blue arrows** in **Figure 3f**. The plug will then pop free with very little effort.
- o) Remove the ECU from the vehicle and set aside in a safe location for later.



**Figure 3e**

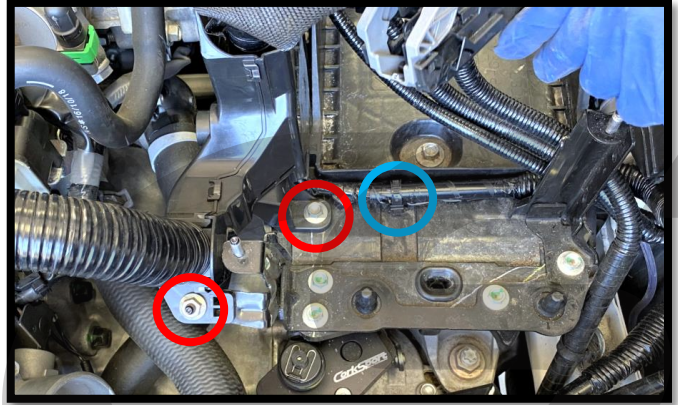
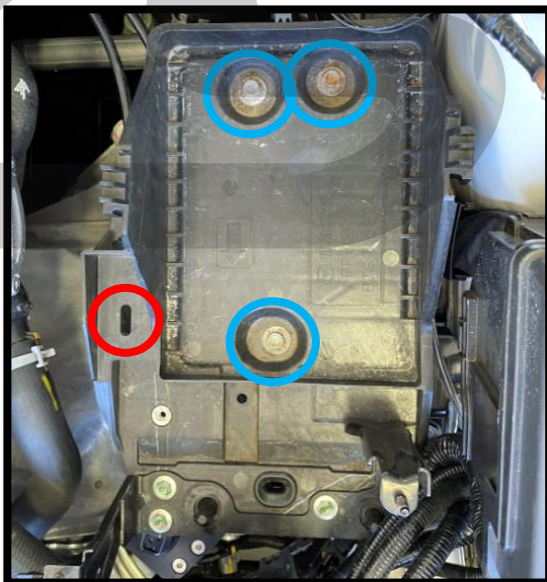
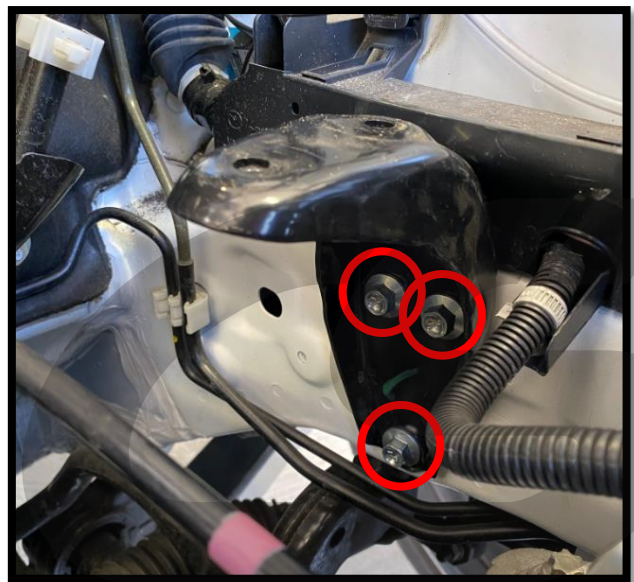


**Figure 3f**



**DETAILED INSTRUCTIONS:****3. Removing the OEM Intake, ECU, & Battery Tray (continued)**

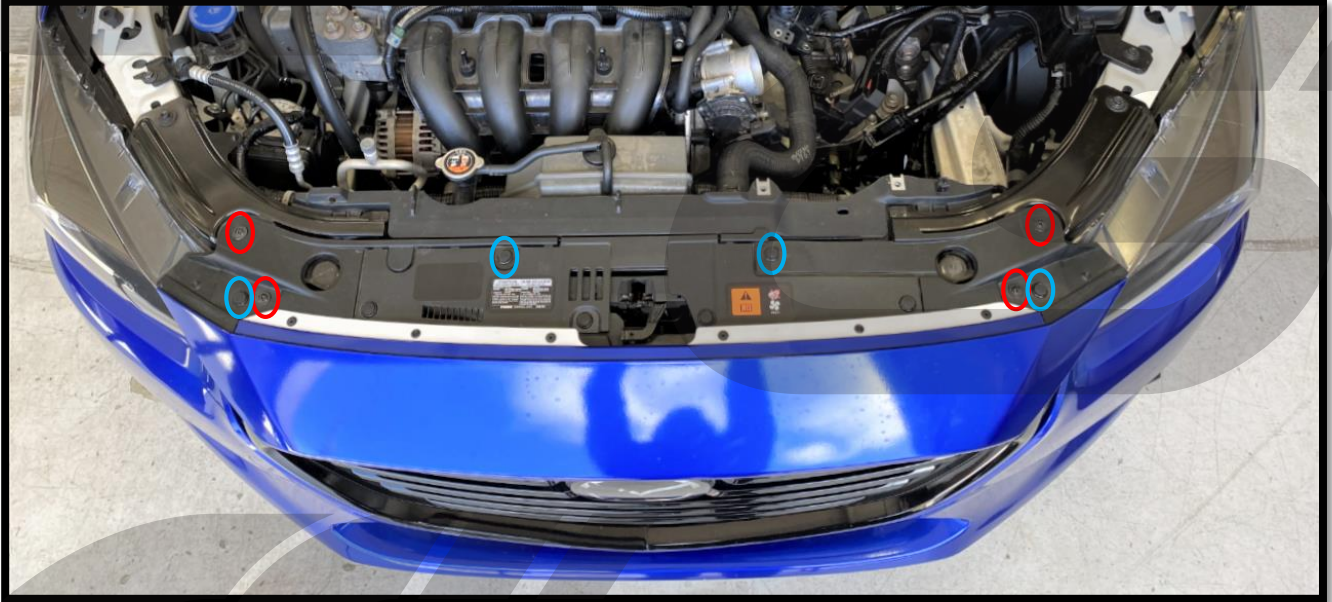
- p) Remove the 10mm bolt and 10mm nut securing the wiring harness to the battery tray. Shown circled in red in **Figure 3g**.
- q) Remove the wiring clip from the battery tray. Clip shown circled in blue in **Figure 3g**.
- r) Remove the wiring harness from the battery tray. There is one more hidden clip which is very difficult to access. The harness should come free with a little effort. Location of this clip shown removed circled in red in **Figure 3h**.
- s) Remove the three battery tray bolts with a 12mm socket and ratchet. Shown circled in blue in **Figure 3h**.
- t) Remove the battery tray from the vehicle.
- u) Remove the rear battery tray mounting bracket by removing the three 12mm bolts that hold it to the chassis rail. Shown circled in red in **Figure 3i**.

**Figure 3g****Figure 3h****Figure 3i**

## **DETAILED INSTRUCTIONS:**

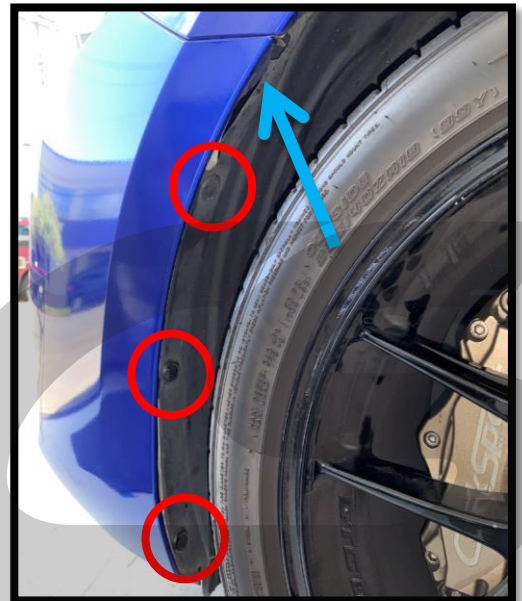
### **4. Removing the OEM Front Bumper & Undertrays**

- a) Remove the four Phillips head screws from the top of the front bumper. Shown **circled in red** in **Figure 4a**.
- b) Remove four push clips from the top of the front bumper. Shown **circled in blue** in **Figure 4a**.



**Figure 4a**

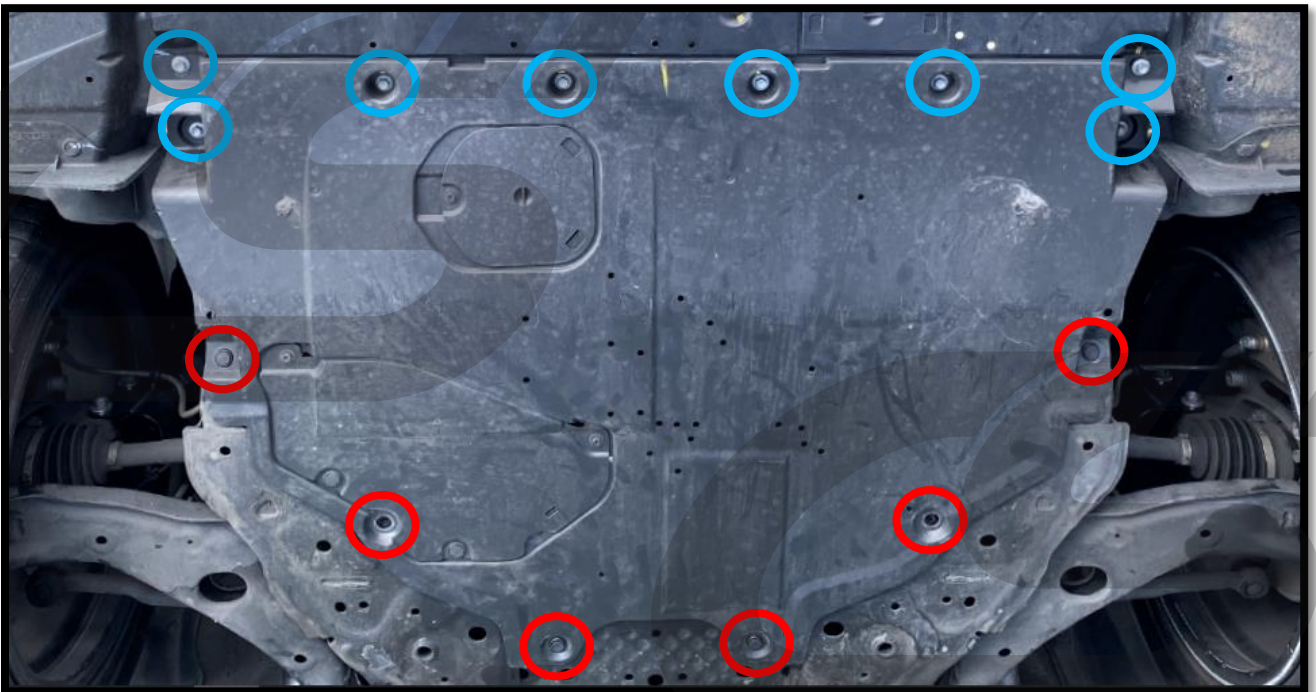
- c) Remove three push clips from the fender liner, in front of the front wheel. Shown **circled in red** in **Figure 4b**.
- d) Pull the fender liner away from the bumper to access the area shown at the corner of the bumper shown with **blue arrow** in **Figure 4b**.



**Figure 4b**

**DETAILED INSTRUCTIONS:****4. Removing the OEM Front Bumper & Undertrays (continued)**

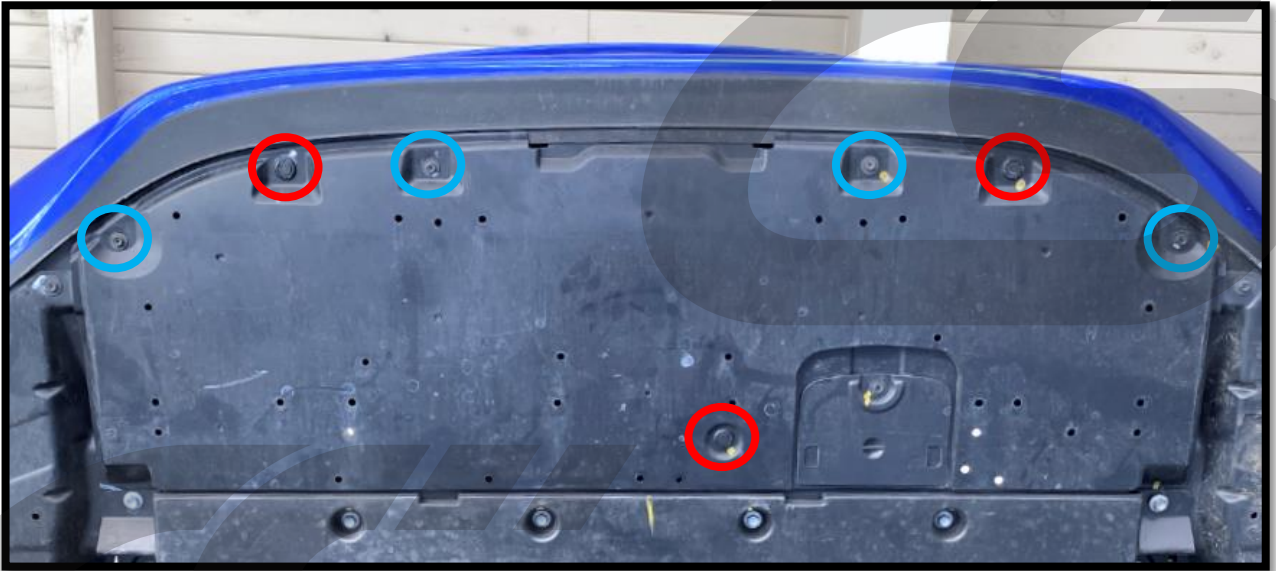
- e) Look into the area accessed in Step 4d to see one 8mm/Phillips head screw. Remove this screw from the corner of the bumper. Shown **circled in red** in **Figure 4c**.
- f) Repeat Steps 4c-4e on the other side of the vehicle.
- g) Remove the six push clips from the rear portion of the engine undertray. Shown **circled in red** in **Figure 4d**.
- h) Remove the eight 10mm bolts from the engine undertray. Then remove the engine undertray from the vehicle. Bolts shown **circled in blue** in **Figure 4d**.

**Figure 4c****Figure 4d**

## **DETAILED INSTRUCTIONS:**

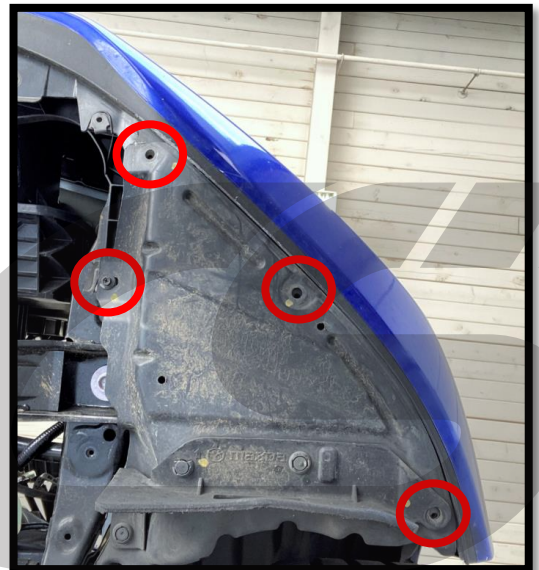
### **4. Removing the OEM Front Bumper & Undertrays (continued)**

- i) Remove the three push clips from the front portion of the engine undertray. Shown **circled in red** in **Figure 4e**.
- j) Remove the four 8mm/Phillips screws from the engine undertray. Then remove the front engine undertray from the vehicle. Bolts shown **circled in blue** in **Figure 4e**.



**Figure 4e**

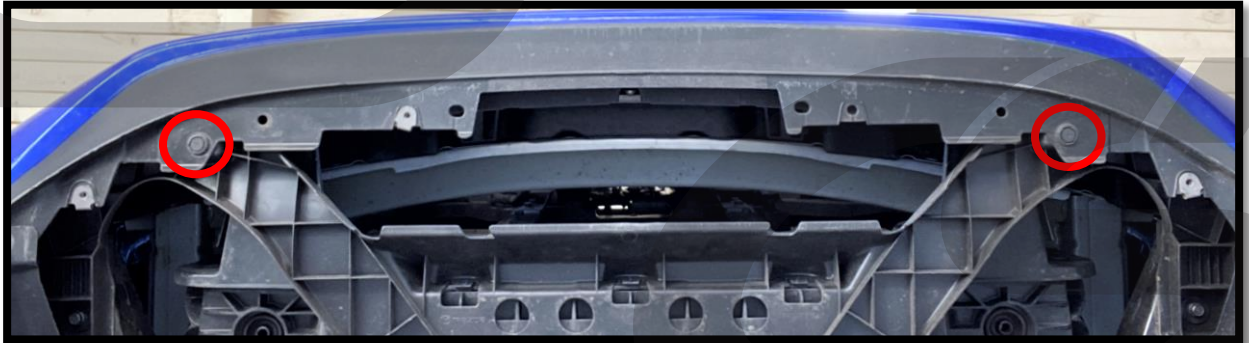
- k) Remove the four 8mm/Phillips screws that connect the fender liner to the front bumper. Bolts shown **circled in red** in **Figure 4f**.
- l) Repeat the previous step on the other side of the vehicle.



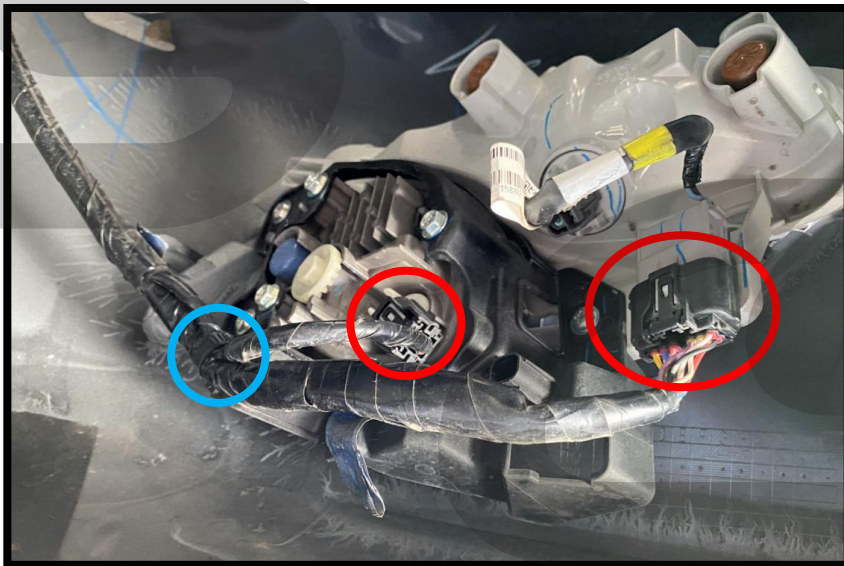
**Figure 4f**

**DETAILED INSTRUCTIONS:****4. Removing the OEM Front Bumper & Undertrays (continued)**

- m) Remove the two push clips that connect the front bumper to the lower bumper support. Shown **circled in red** in **Figure 4g**.

**Figure 4g**

- n) Pull down the bottom of the fender liner that was loosened in Step 4k.
- o) Disconnect the fog light and turn signal wiring harness. There are two wiring connectors **circled in red** in **Figure 4h** and one wiring clip **circled in blue** in **Figure 4h** that will need to be disconnected.
- p) Repeat the previous two steps on the opposite side of the vehicle.

**Figure 4h**

## DETAILED INSTRUCTIONS:

### 4. Removing the OEM Front Bumper & Undertrays (continued)

q) **OPTIONAL:** Place some blue masking tape around the seam between the bumper and the fender/headlight as shown in **Figure 4i**. This helps prevent scratches while removing/reinstalling the front bumper.

r) Pull outward on the corner of the bumper to pop it free from the clips near the fender. Pull in the direction shown with the **red arrow** in **Figure 4i**. It will look like **Figure 4j** when completed.

s) Repeat the previous step on the other side of the bumper.



**Figure 4i**

**NOTE** We recommend getting a friend to help with the final bumper removal.

t) Place your hands in the locations shown with the **red circles** in **Figure 4j**.

u) Pull the bumper forward to pop it free from the two large clips securing it to the vehicle. One clip is located near each corner of the grill, one location shown with **green circle** in **Figure 4j**.

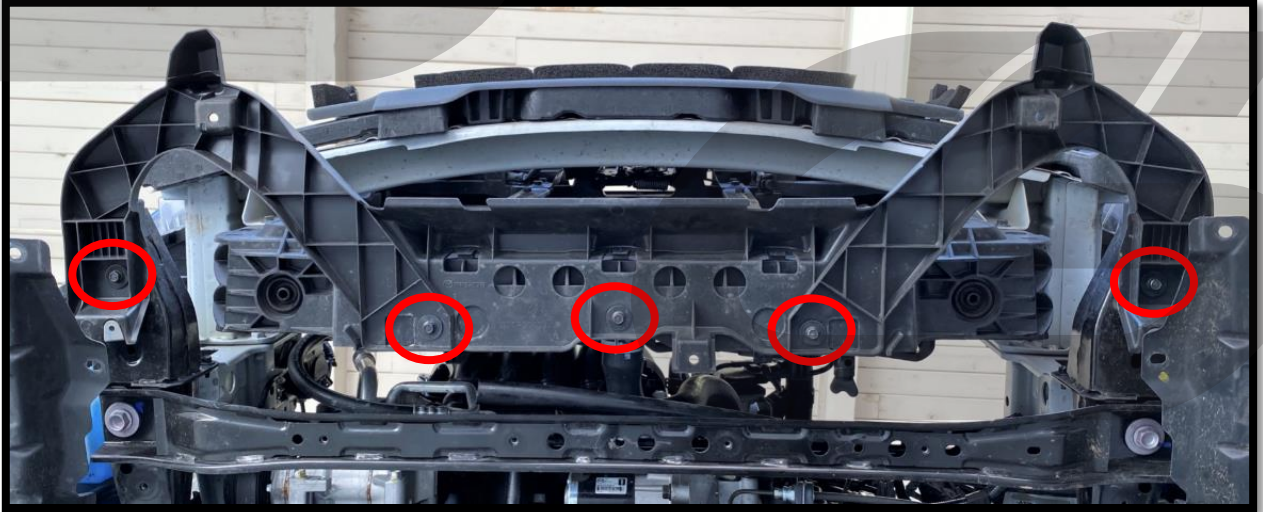
v) Once the clips pop free, the bumper can be removed from the vehicle. Set the bumper aside where it is safe from any damage.



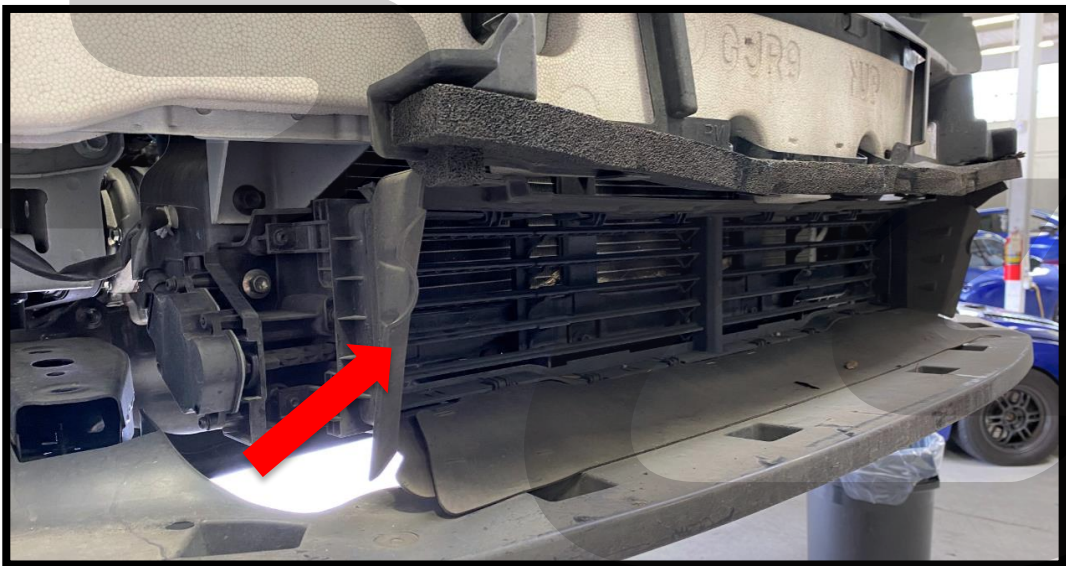
**Figure 4j**

**DETAILED INSTRUCTIONS:****4. Removing the OEM Front Bumper & Undertrays (continued)**

- w) Remove the five 10mm bolts that secure the lower front bumper brace to the vehicle. Shown **circled in red** in **Figure 4k**. The brace can then be unclipped from the core support and removed from the vehicle.

**Figure 4k**

- x) Some vehicles have a lower radiator air shutter assembly as shown in **Figure 4l**. This will need to be removed for intercooler install. If your vehicle does not appear as shown, skip to Page 33.

**Figure 4l**

## DETAILED INSTRUCTIONS:

### 4. Removing the OEM Front Bumper & Undertrays (continued)

- y) Remove the four 10mm bolts that secure the air shutter to the vehicle. There are two bolts on the bottom of the air shutter as shown with red circles in Figure 4m. There is one bolt on each side as shown with red circle in Figure 4n.

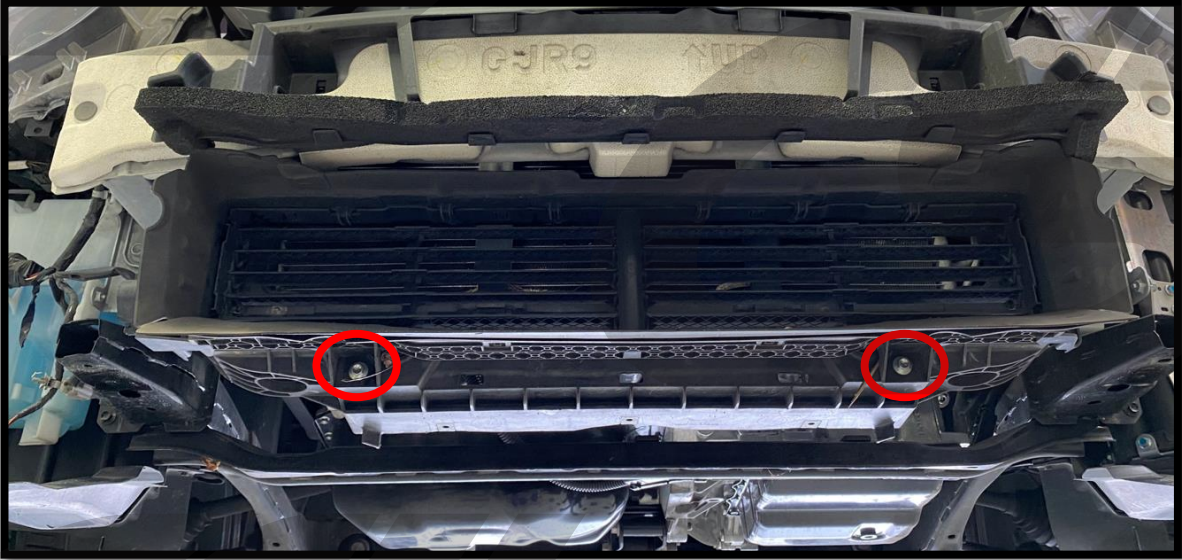


Figure 4m

- z) Unplug the air shutter motor. Shown with blue arrow in Figure 4n. We will reinstall the motor by itself in a later step.

- aa) Remove the air shutter assembly from the vehicle.

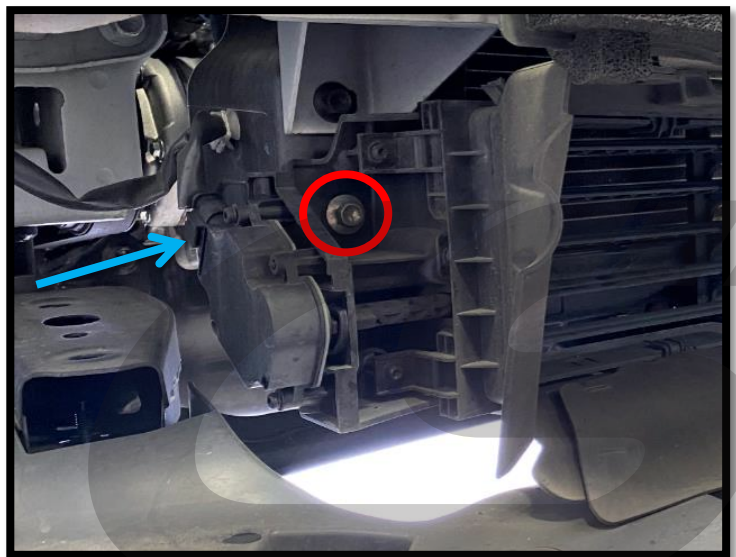


Figure 4n



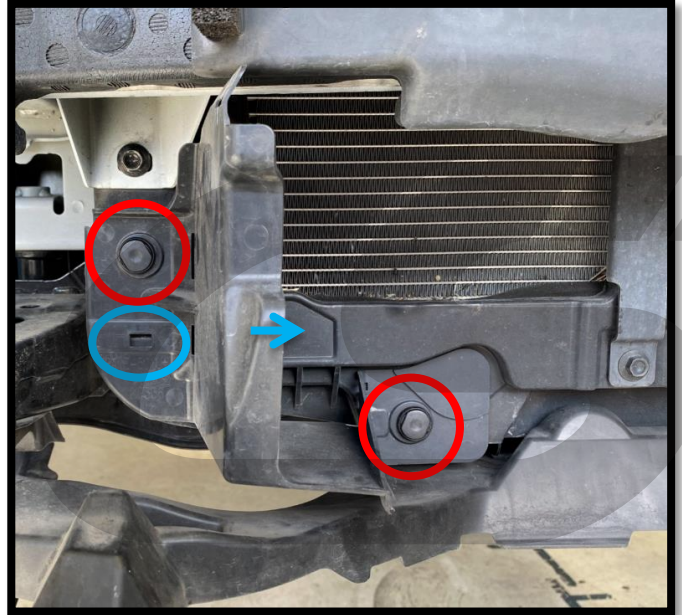
## DETAILED INSTRUCTIONS:

### 4. Removing the OEM Front Bumper & Undertrays (continued)



If your vehicle had an air shutter assembly you just removed, skip to Section 5 on the next page.

- bb) Remove the two push clips from the lower radiator air guide. Shown **circled in red** in **Figure 4o**.
- cc) Remove the lower radiator air guide. It is secured with a locking tab **circled in blue** in **Figure 4o**. This can be released from the backside of the radiator and the air guide pulled free.
- dd) Repeat the previous two steps for the lower radiator air guide on the other side of the vehicle.



**Figure 4o**

## DETAILED INSTRUCTIONS:

### 5. Removing the OEM Header

- a) Remove the four push clips from the silver shielding underneath the vehicle. Shown circled in red in Figure 5a.
- b) Remove the five 10mm bolts from the shielding underneath the vehicle. Shown circled in blue in Figure 5a. The silver shielding can then be removed.
- NOTE** The next two steps are optional as the header can be disconnected without removing the chassis brace. It is much easier to access with the chassis brace removed.
- c) **OPTIONAL:** Remove the six 12mm bolts from the underbody brace. Shown circled in green in Figure 5a. Two of these bolts are hidden and are shown with the green arrows.
- d) **OPTIONAL:** Remove the forward chassis brace. There is a tab on each side that must slide out of a slotted hole on each frame rail. Then the brace can be removed by sliding it rearwards.
- e) Locate the end of the OEM header. Remove the two 14mm nuts that connect it to the exhaust. Shown circled in red in Figure 5b.
- f) Remove the rubber hanger from the end of the OEM header. Shown with the blue arrow in Figure 5b. Exhaust hanger pliers are the easiest tool to use for this.

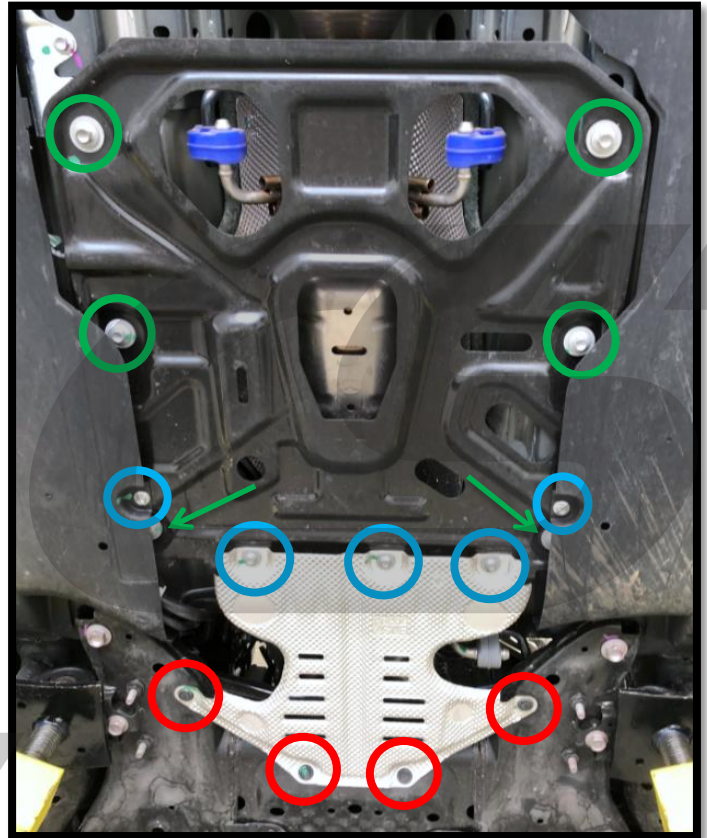


Figure 5a

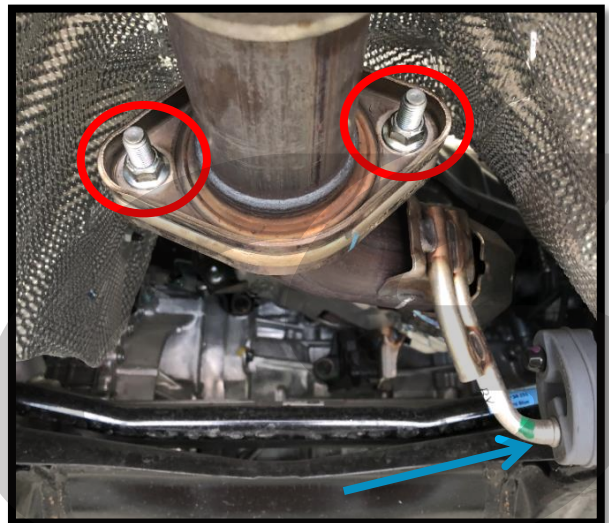


Figure 5b

## DETAILED INSTRUCTIONS:

### 5. Removing the OEM Header (continued)

- g) While still under the car, locate the lower header mounting brackets. They are shown circled in red in Figure 5c and Figure 5d.
- h) Remove the 14mm bolt that attaches the OEM header to the bracket near the transmission. Shown circled in blue in Figure 5c.
- i) Remove the 14mm bolt that attaches the OEM header to the bracket near the engine oil pan. Shown with the blue arrow in Figure 5d.

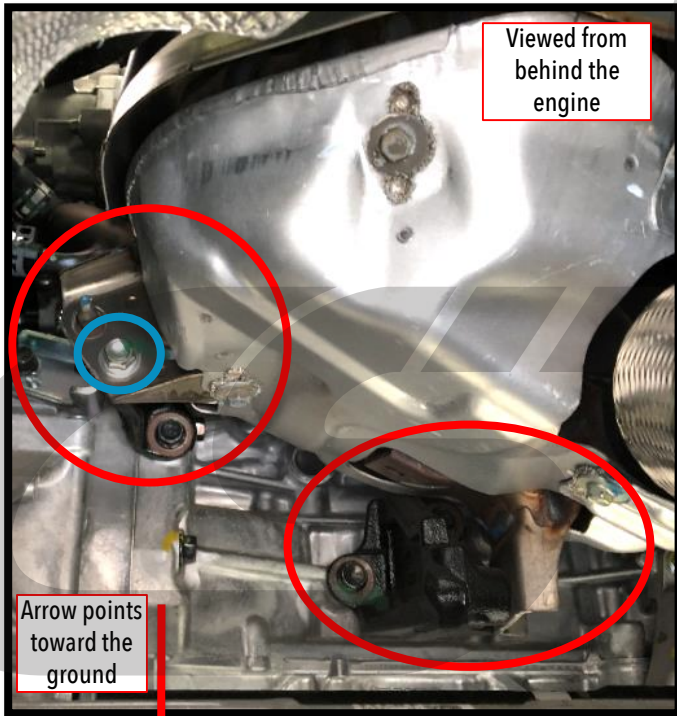


Figure 5c

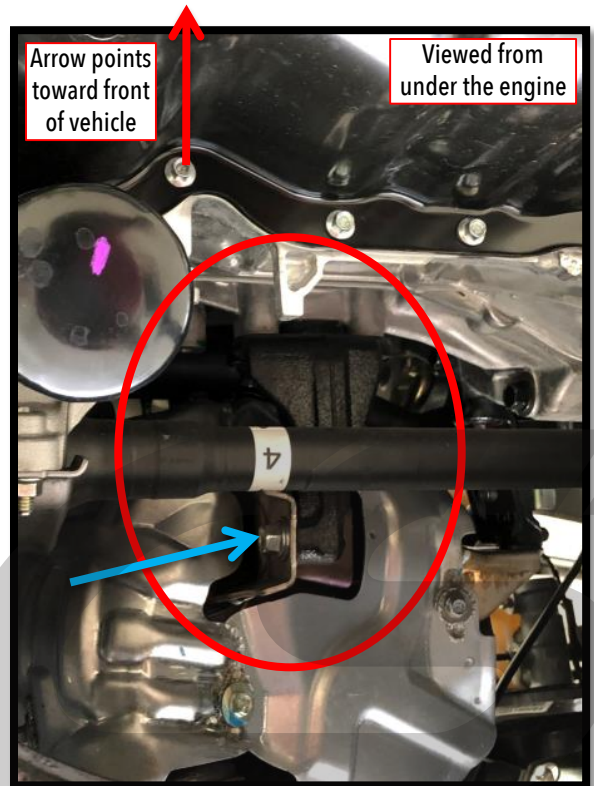
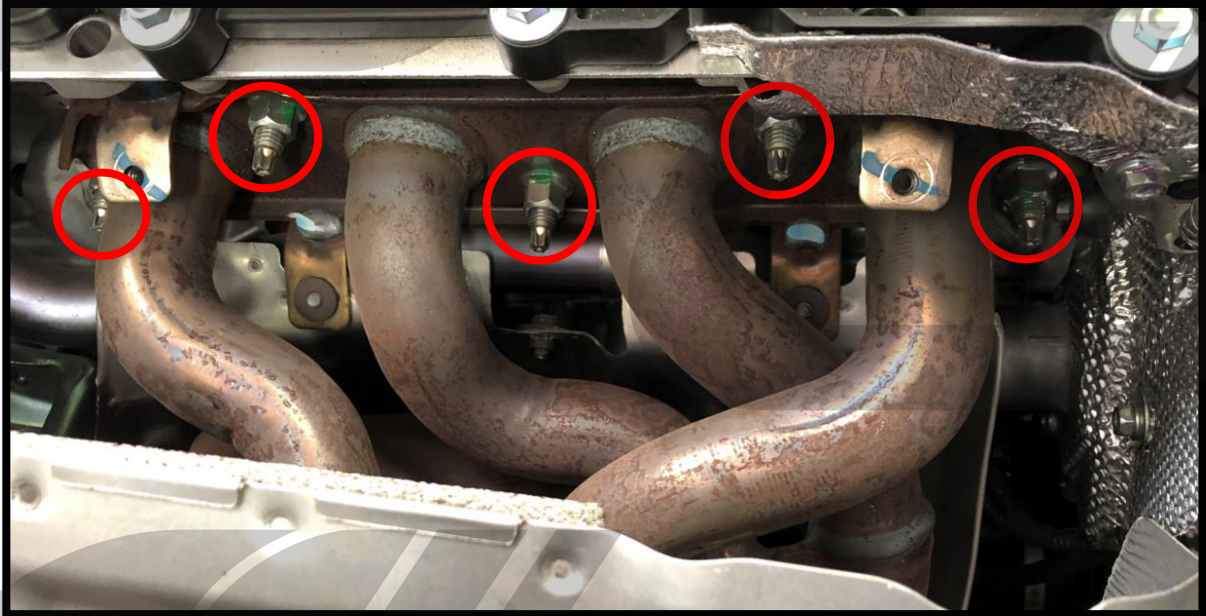


Figure 5d

## **DETAILED INSTRUCTIONS:**

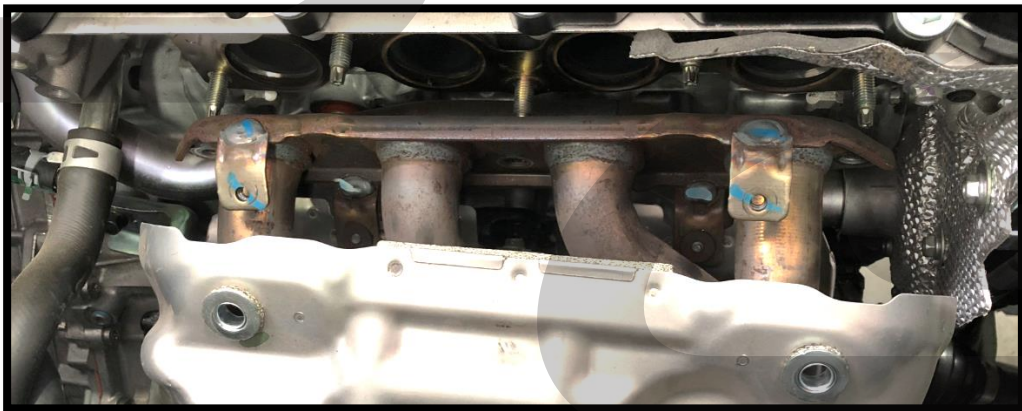
### **5. Removing the OEM Header (continued)**

- j) Back in the engine bay, remove the five 14mm nuts that attach the OEM header to the engine. Shown **circled in red** in **Figure 5e**.




**Figure 5e**

- k) Slide the OEM header off its mounting studs and let it sit lower down in the engine bay. This is shown in **Figure 5f**.
- l) The heatshield disconnected in Step 2i -2j can then be removed from the engine bay.

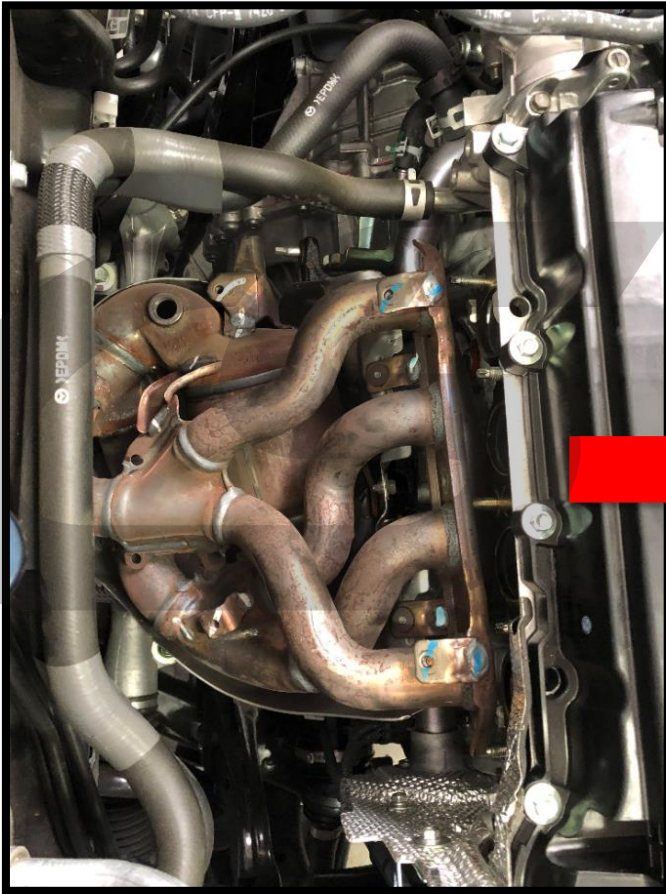


**Figure 5f**

**DETAILED INSTRUCTIONS:****5. Removing the OEM Header (continued)**

 Extracting the OEM header from the engine bay can be difficult. Take your time and be sure you do not damage any wiring, hoses, or other engine bay components during removal. A friend underneath the car can be very useful during this process as the lower exhaust hanger tends to get caught on the steering rack and swaybar during header removal. Check out the install video near the 13minute mark to see the header being removed.

- m) After the previous step, the OEM header should be in a position similar to **Figure 5g**.
- n) Begin the removal process by lifting the header while rotating it toward the rear of the car and slightly clockwise. **Figure 5h** should be your next target position and orientation.

**Figure 5g****Figure 5h**

## DETAILED INSTRUCTIONS:

### 5. Removing the OEM Header (continued)

- o) Next, the lower support bracket mount will need to clear the top of the engine. This is the mounting that was removed in Step 5i. You will need to rotate the OEM header until you find the orientation that works for getting this mount clear of the top of the engine. Mounting point circled in red in Figure 5h and Figure 5i.



Figure 5i

- p) The other support bracket mount will now need to clear the top of the engine. This is the mounting that was removed in Step 5h. You will need to rotate the OEM header until you find the orientation that works for getting this mount clear of the top of the engine. Mounting point circled in blue in Figure 5h and Figure 5j.

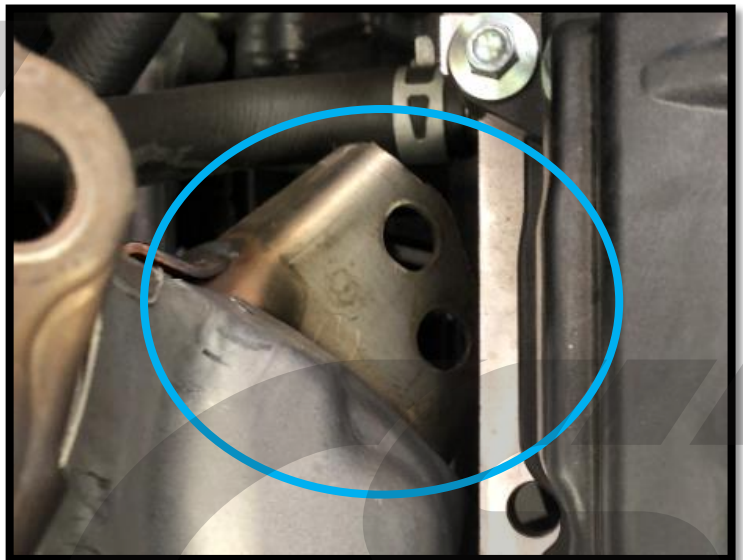


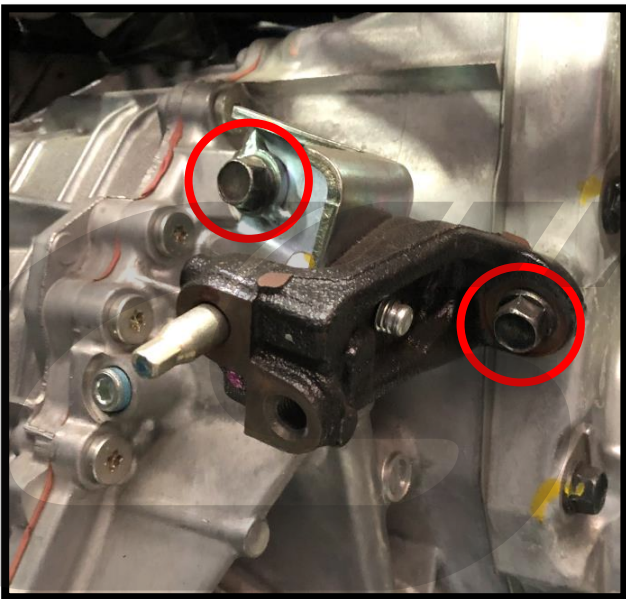
Figure 5j

- q) The OEM header can now be removed from the vehicle.

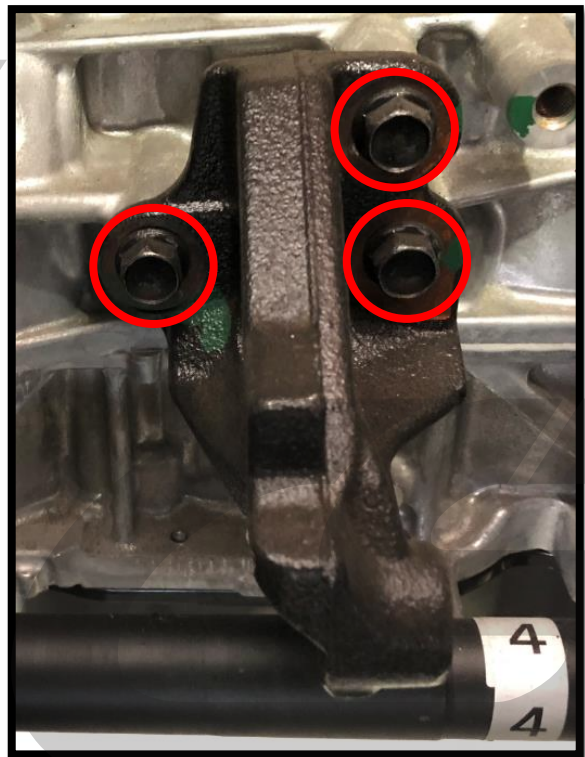
## **DETAILED INSTRUCTIONS:**

### **5. Removing the OEM Header (continued)**

- r) Remove the two 14mm bolts from the support bracket near the transmission. This is the same location where the OEM header was unbolted in Step 5h. Shown **circled in red** in **Figure 5k**.
  
- s) Remove the three 14mm bolts from the support bracket near the engine oil pan. This is the same location where the OEM header was unbolted in Step 5i. Shown **circled in red** in **Figure 5l**.



**Figure 5k**



**Figure 5l**

## DETAILED INSTRUCTIONS:

### 6. Removing the OEM Oil Pan



Removing the oil pan can be difficult. Read the instructions carefully to make the process easy and to prevent any damage.

- a) Remove the drain plug using an 8mm Allen wrench or 17mm wrench and drain the oil from your engine. Plug shown circled in red in **Figure 6a**. Take a break while your oil drains.
- b) Remove the oil filter from the vehicle. Shown with **blue arrow** in **Figure 6a**. This allows easier access to the oil pan sealing flange.
- c) Remove the twenty (20) 8mm bolts from around the edge of the oil pan flange. Shown **circled in red** in **Figure 6b**.

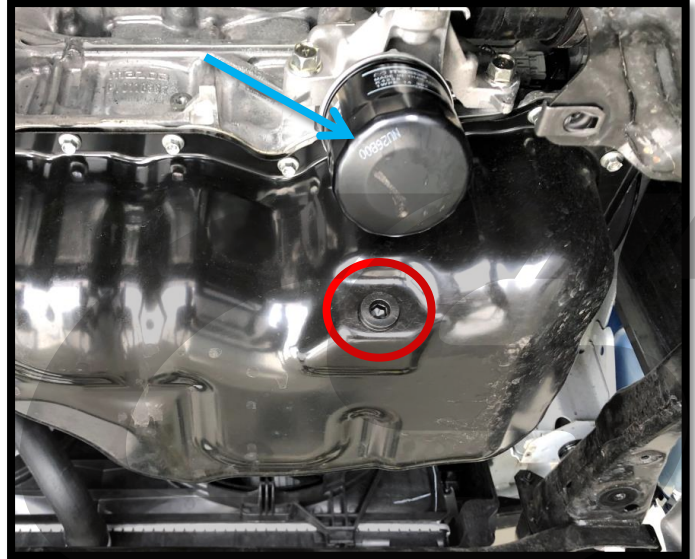


Figure 6a

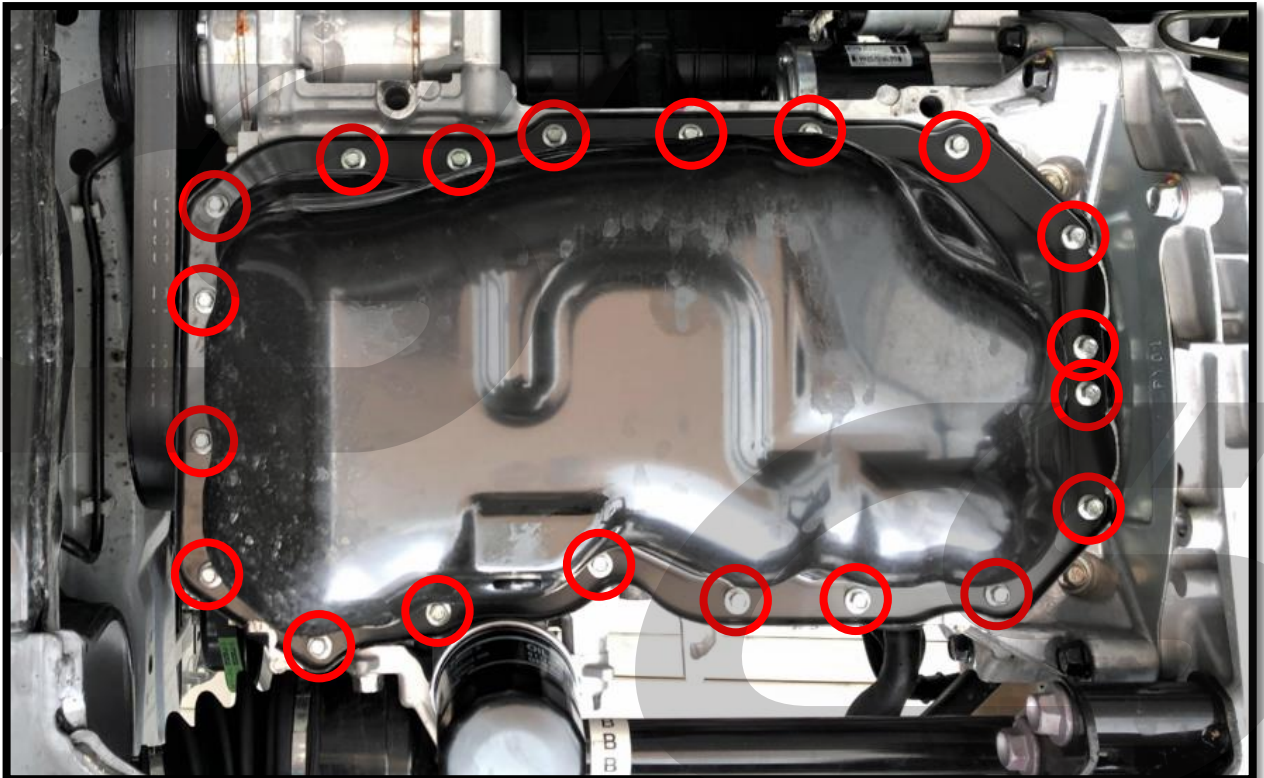


Figure 6b



## DETAILED INSTRUCTIONS:

### 6. Removing the OEM Oil Pan (continued)

**NOTE**

We strongly encourage the use of an oil pan separator tool like shown in **Figure 6c**. This makes oil pan removal much easier and safer than trying to pry with screwdrivers or similar.

- d) Using an oil pan separator tool, putty knife, or similar, work your way around the front of the oil pan to cut the old silicone that is securing the pan to the engine block. Area shown with **red square** in **Figure 6d**. You may need to use a hammer to help your separator tool cut thru the silicone.

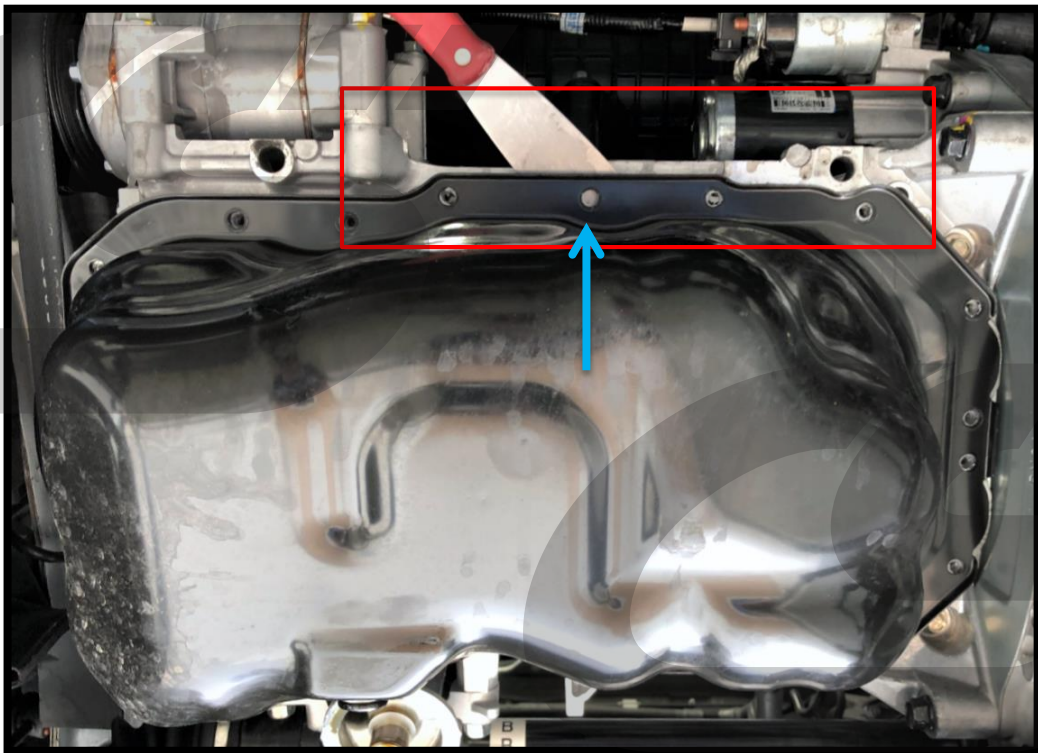


Use extreme caution during Step 6d. There are engine components that could be damaged if your tool goes into the engine more than approximately 1" in some areas. See Figure 6g on page 41 for reference.

- e) Once the front edge is mostly broken free, position your separator tool at the center hole as shown with **blue arrow** in **Figure 6d**.



**Figure 6c**



**Figure 6d**

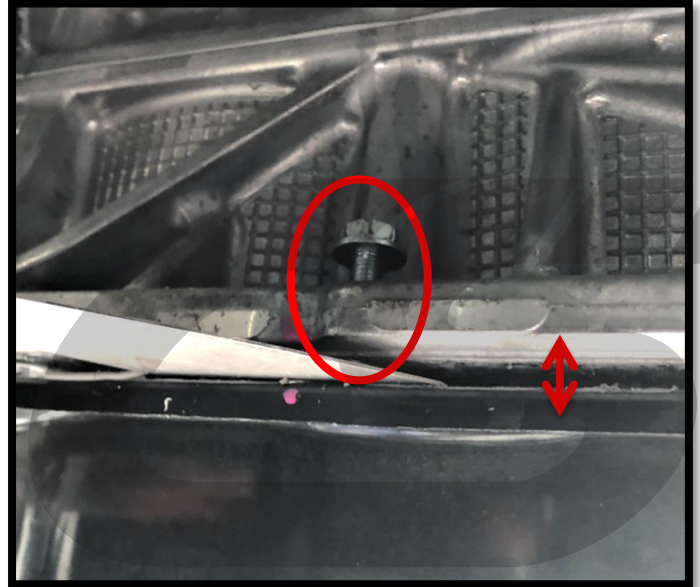
## **DETAILED INSTRUCTIONS:**

### **6. Removing the OEM Oil Pan (continued)**

- f) Thread one of the oil pan bolts or another M6 bolt in from the top side of the oil pan sealing flange. Tightening this bolt slowly against your separator tool will push the oil pan away from the engine block and break loose more of the silicone. Shown in progress in **Figure 6e**.
- g) Once the gap is large enough, you should be able to grip the edge of the oil pan and tear the rest of the silicone to remove the oil pan. Shown in progress in **Figure 6f** and completed in **Figure 6g** on the next page.



Once the pan is removed, the engine will drip oil slowly from all over. Put down cardboard to prevent a mess.



**Figure 6e**



**Figure 6f**

## DETAILED INSTRUCTIONS:

### 6. Removing the OEM Oil Pan (continued)

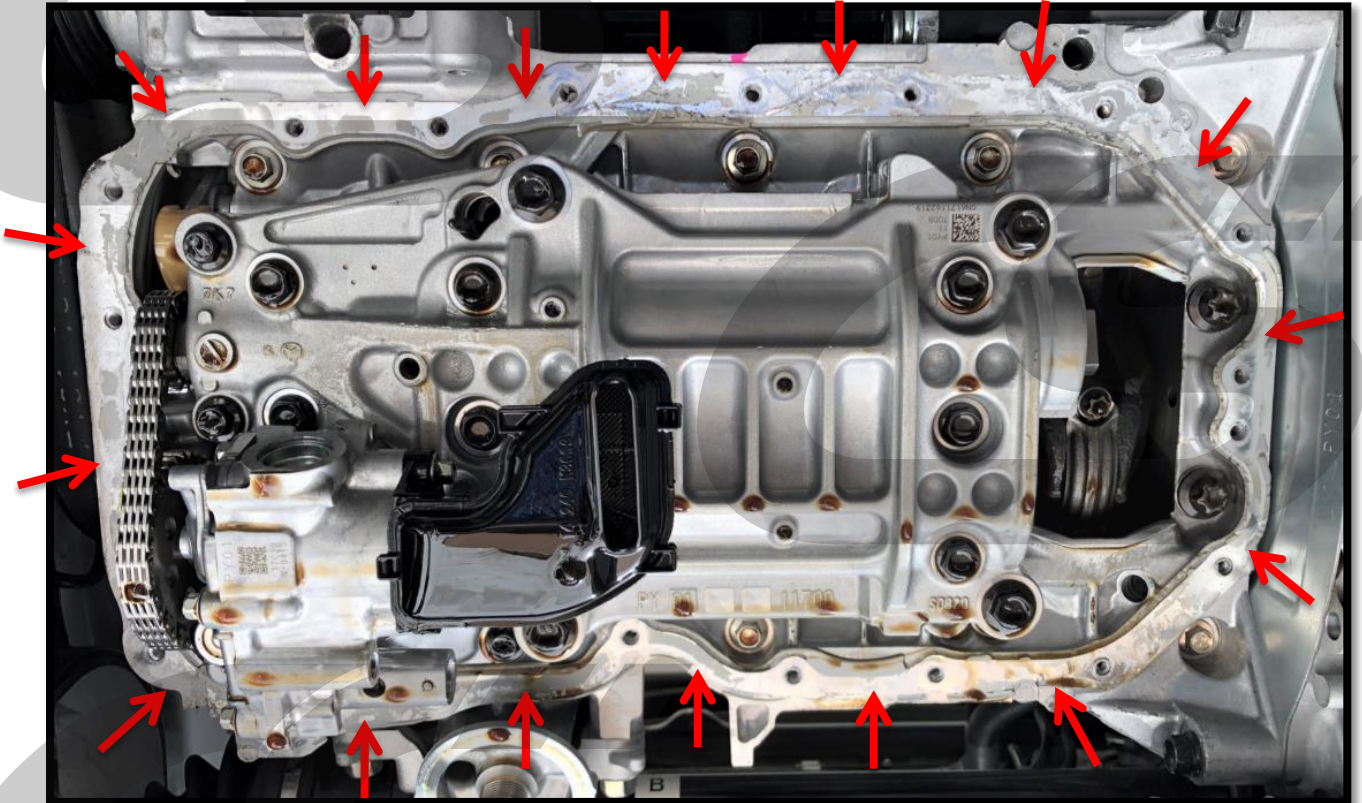


Figure 6g

### 7. Preparing & Installing the CS Modified Oil Pan

- a) **Begin by cleaning the engine block sealing surface.** All old sealant and oil must be removed to ensure a good seal. Area to clean shown with **red arrows** in **Figure 6g**. Cleaned sealing surface shown in **Figure 7b** on the next page.



Ensure **NO** loose silicone residue is present on any engine components or in locations where the residue could get sucked into the oiling system.



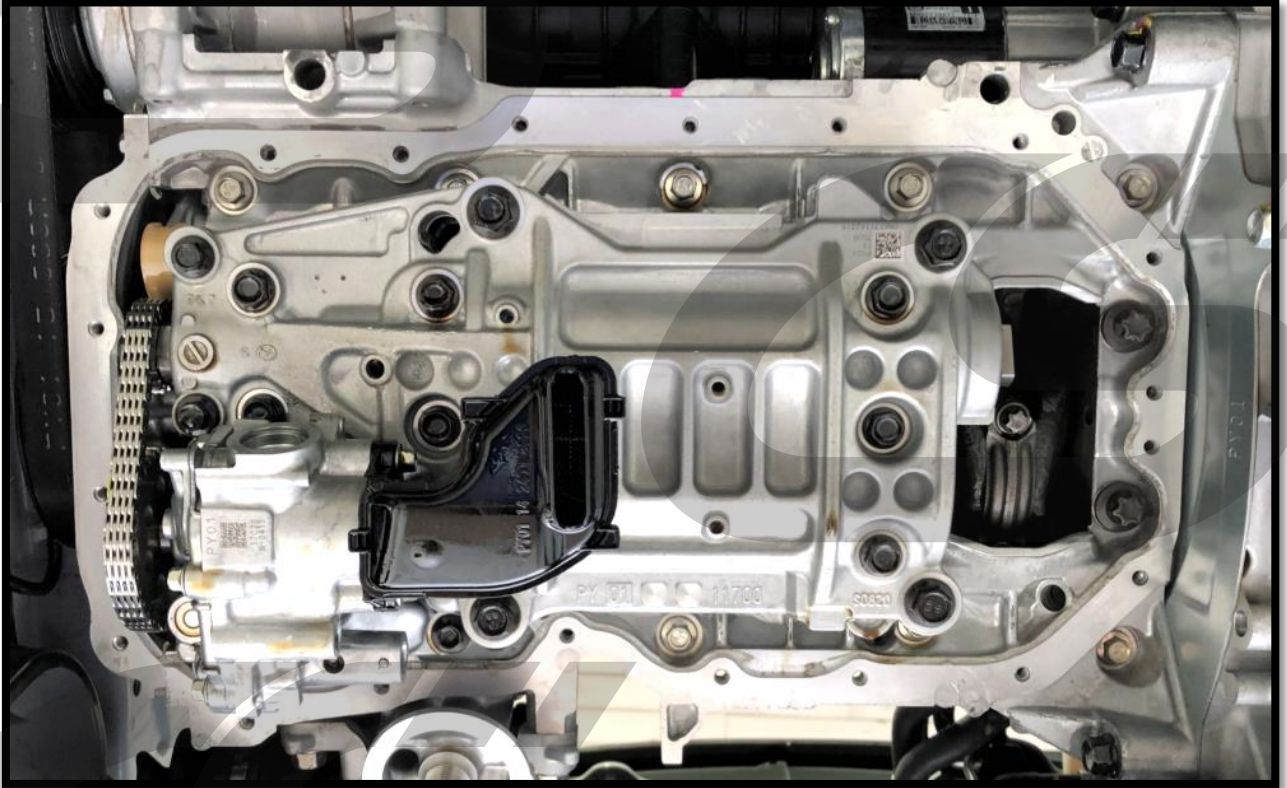
Plastic razor blades like shown in **Figure 7a** can be very useful when cleaning the old silicone residue. Regular razor blades can also be used, but extra caution must be used to prevent damage to the aluminum engine block.



Figure 7a

## **DETAILED INSTRUCTIONS:**

### **7. Preparing & Installing the CS Modified Oil Pan (continued)**



**Figure 7b**


- b) **Clean off all oil pan bolts.** All silicone sealant must be removed to prevent potential damage to the engine block. Dirty and clean bolt shown in **Figure 7c**.




**Figure 7c**

## DETAILED INSTRUCTIONS:

### 7. Preparing & Installing the CS Modified Oil Pan (continued)

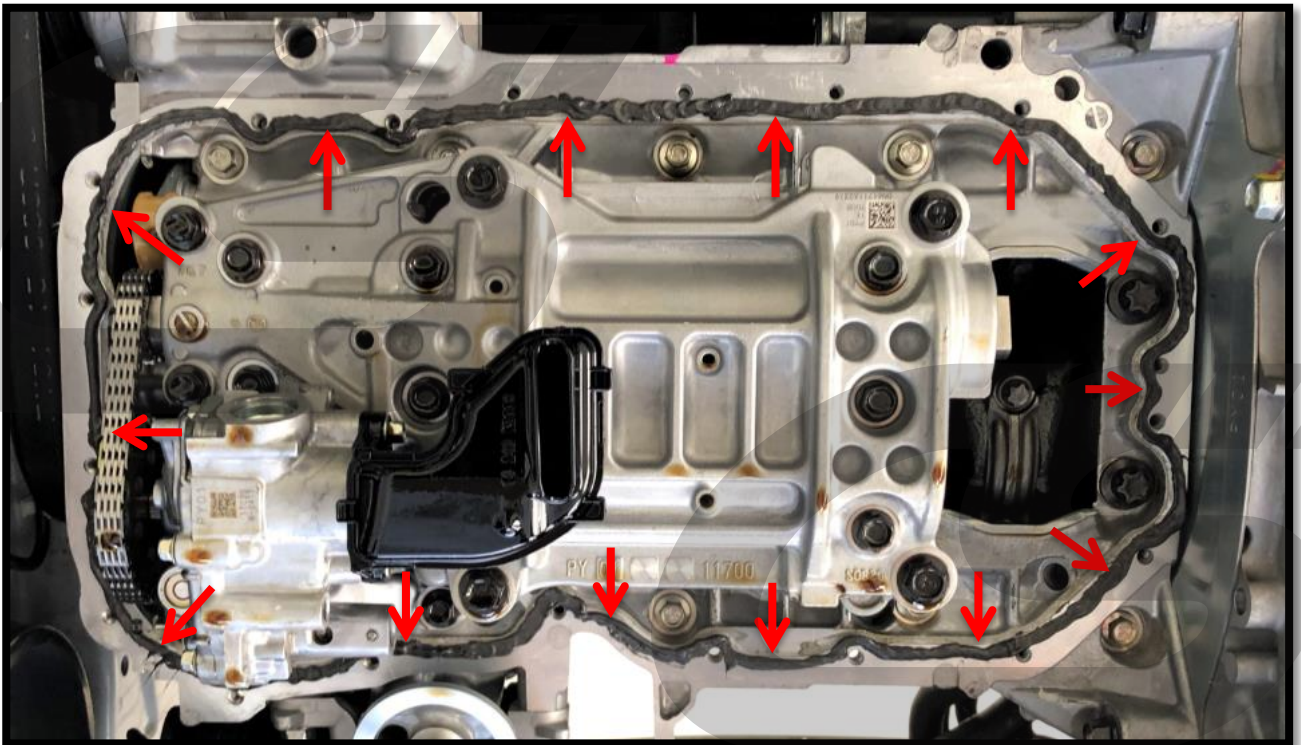
 Before applying any silicone sealant, clean the engine block sealing surface and the CS oil pan sealing surface with brake parts cleaner or similar to ensure no oily residue. Ensure it is completely dry before applying sealant.

 We recommend Permatex Optimum Black silicone for a high quality seal. Shown in **Figure 7d**.



**Figure 7d**

c) Apply silicone sealant to the engine block sealing surface in a consistent  $\sim 1/4$ " wide bead. The bead should travel just on the inside of all the holes, as shown in **Figure 7e**. Ensure no gaps in the bead or you will have an oil leak.



**Figure 7e**

## DETAILED INSTRUCTIONS:

### 7. Preparing & Installing the CS Modified Oil Pan (continued)

- d) Lift the CS modified oil pan into position and line it up with the holes in the engine block.
- e) Secure the oil pan with two bolts in the locations circled in red in Figure 7f. Only tighten finger tight for now.

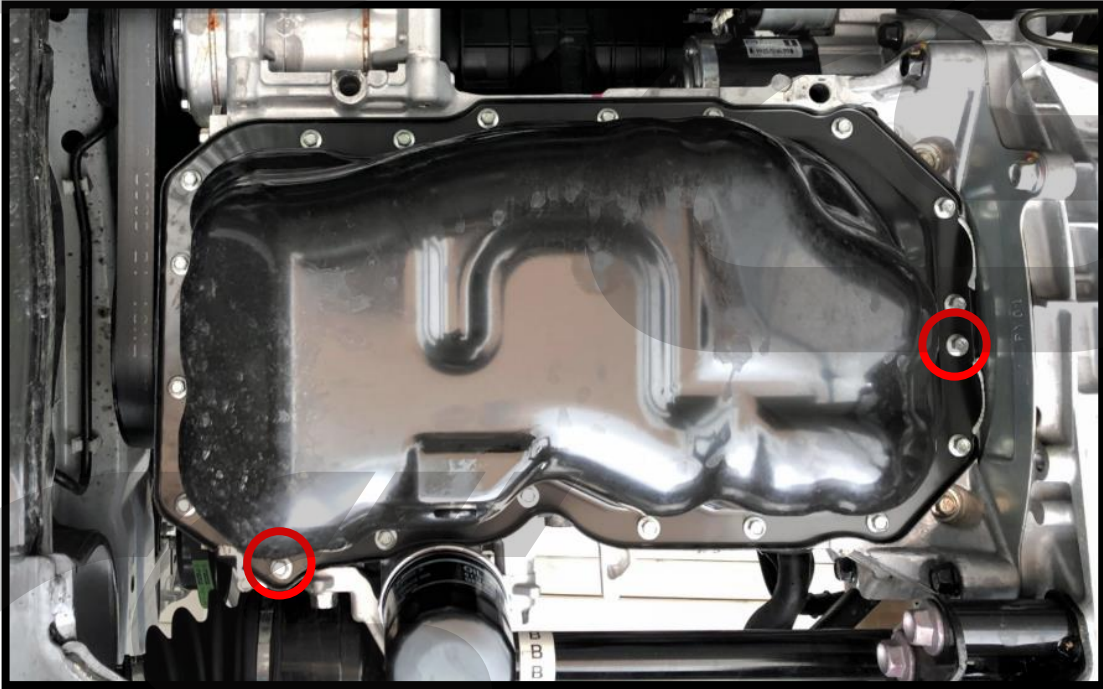


Figure 7d

- f) Hand thread in all the remaining oil pan bolts.
- g) Final tighten the oil pan mounting bolts to **72-96in-lbs (6-8ft-lbs)** following the order shown in Figure 7e.
- h) Ensure you wait 24 hours before adding oil to the oil pan. This gives sufficient time for the silicone to cure.

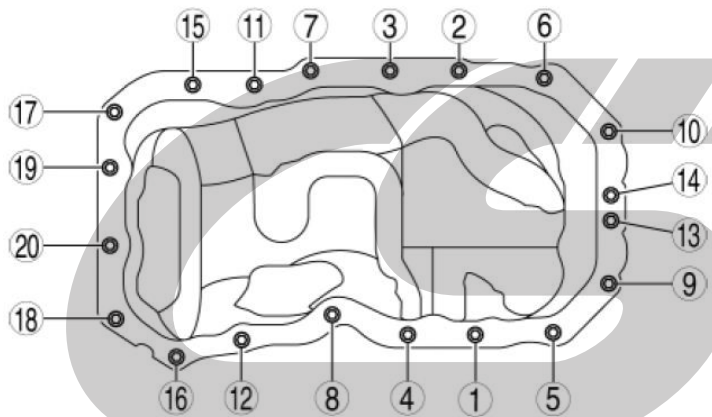


Figure 7e

## DETAILED INSTRUCTIONS:

### 8. Coolant and Oil Feed Line Preparation

- a) Drain the coolant from the radiator. Remove the radiator cap, then move under the car and remove the radiator drain plug from the bottom of the radiator. Plug shown circled in red in Figure 8a.



The coolant can be saved in a clean container and re-used if desired. If new coolant is used or extra is needed, ensure you use FL-22 or compatible coolant.

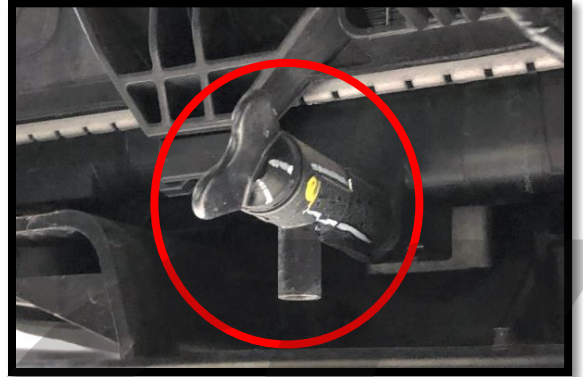


Figure 8a

- b) While the coolant is draining, locate the OEM oil pressure sensor. It is on the rear of the engine block, on the passenger side. It sits right above the axle as shown with red circle in Figure 8b.
- c) Disconnect the plug going to the OEM oil pressure sensor.
- d) Remove the OEM oil pressure sensor using an adjustable wrench. Some oil may drip from this port after the sensor is removed.

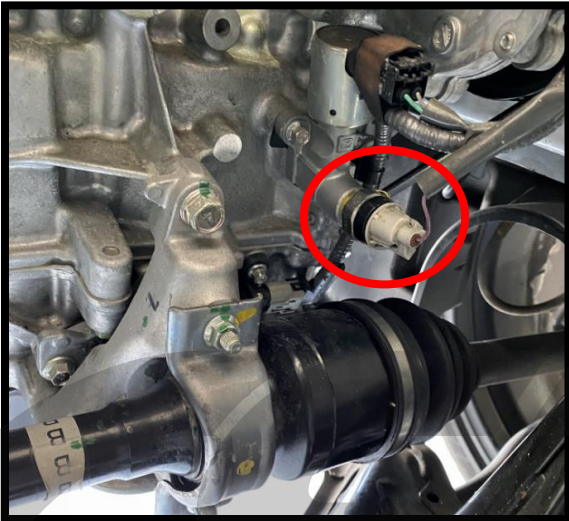


Figure 8b

- e) Locate the oil feed tee components. They are packaged with the turbocharger. Shown in Figure 8c.
- f) Apply fuel/oil safe PTFE thread tape or sealant to the NPT threads of the fittings and OEM sensor as shown in yellow in Figure 8c. The plug packaged with these parts will be used in a later step.



Ensure no openings in the fittings are blocked with PTFE tape.



Do not apply thread tape/sealant to the -4AN side of the NPT to AN adapter. This is the side with the "tapered" end shown with red arrow in Figure 8c.

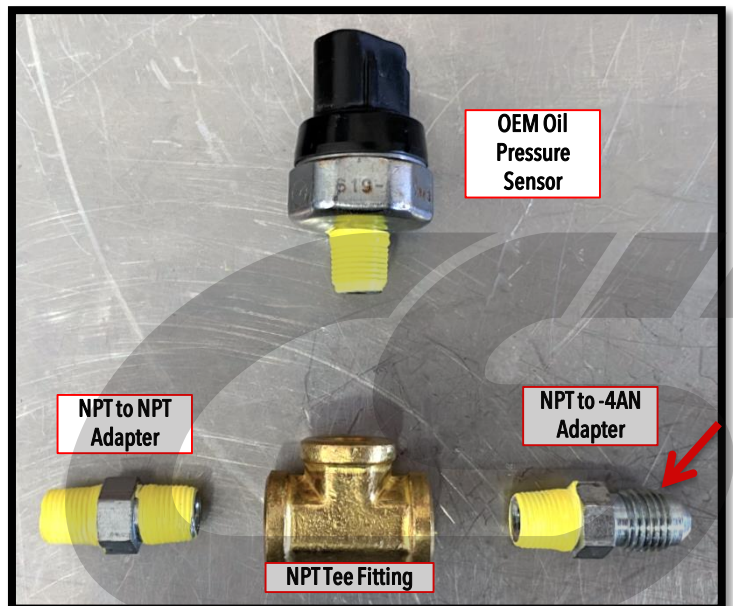


Figure 8c

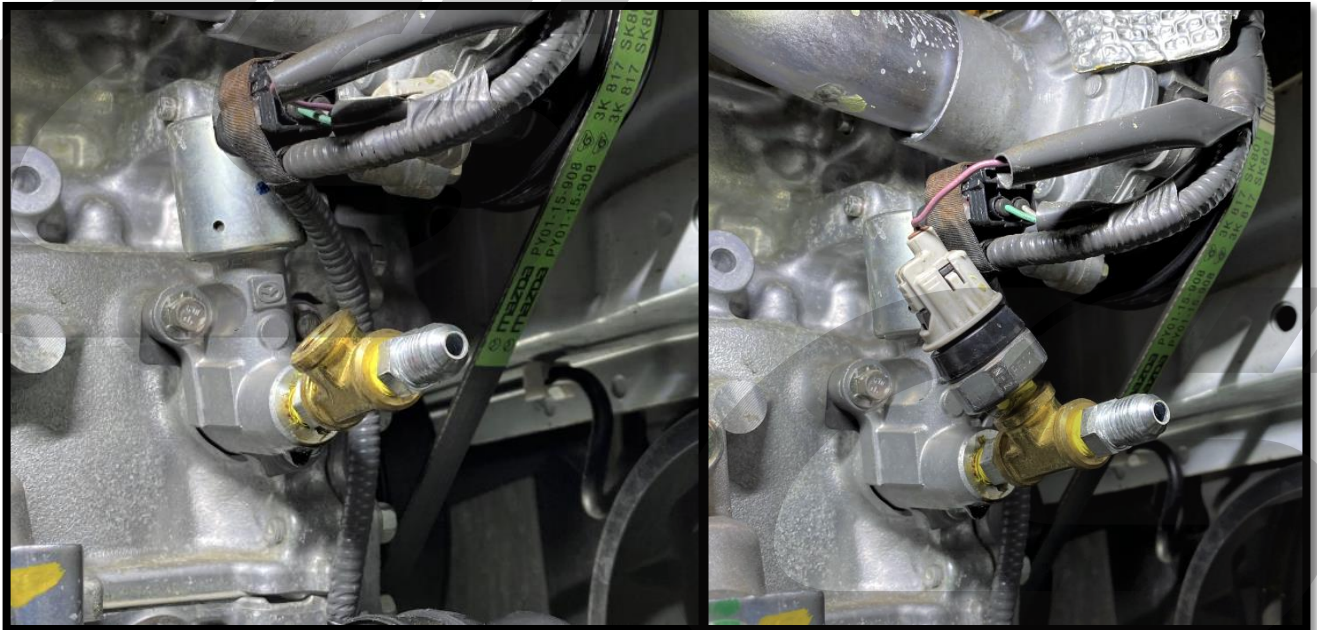
## DETAILED INSTRUCTIONS:

### 8. Coolant and Oil Feed Line Preparation (continued)

- g) Assemble the oil pressure Tee fitting with the NPT to NPT adapter and NPT to AN adapter. Tighten the fittings hand tight, then 1.5-3 additional turns to ensure a good seal. Shown completed in **Figure 8d**. Use a 14mm wrench to hold the Tee and a 12mm wrench to tighten the fittings.
- h) Clean the OEM oil pressure sensor port in the engine block. Remove excess oil and any old sealant to ensure a good seal.
- i) Install the tee & fitting assembly into the OEM oil pressure sensor port. Tighten hand tight, plus 1.5-3 turns using a 14mm wrench on the tee until it lines up as shown in **Figure 8e**. The open top port of the tee should be angled slightly toward the center of the vehicle as shown. The -4AN fitting without thread tape will face rearward.
- j) Install the OEM oil pressure sensor into the top port of the tee. Tighten hand tight plus 1.5-3 turns using an adjustable wrench. Then, reconnect the electrical plug disconnected earlier. Shown completed in **Figure 8f**. The -4AN open port will connect to the turbo oil feed line in a later step.



**Figure 8d**



**Figure 8e**

**Figure 8f**



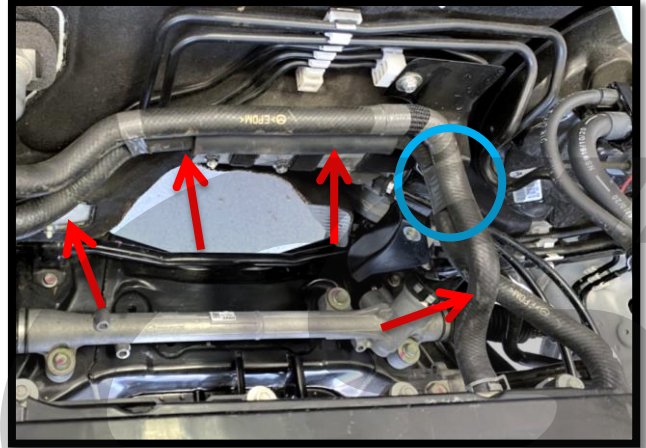
## DETAILED INSTRUCTIONS:

### 8. Coolant and Oil Feed Line Preparation (continued)

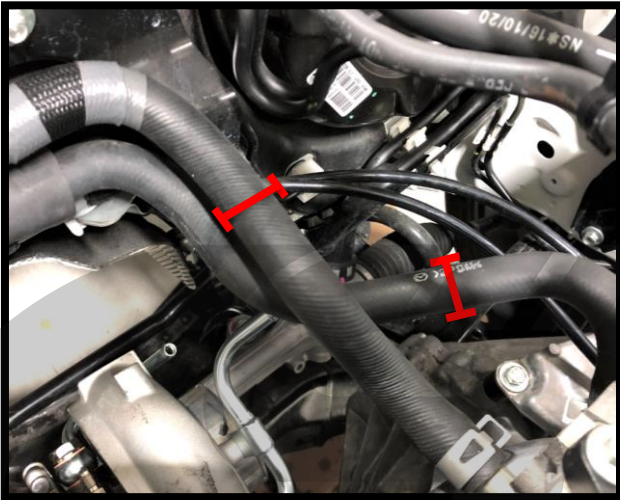


When the coolant hoses are cut in the a later step, they will leak coolant. Use a cup to catch as much coolant as you can to prevent a mess.

- k) Locate the heater core coolant hoses at the back of the engine bay. Shown with **red arrows** in **Figure 8g**.
- l) Carefully remove the gray tape that is holding the two hoses together with scissors or a razor blade. **Circled in blue** in **Figure 8g**.

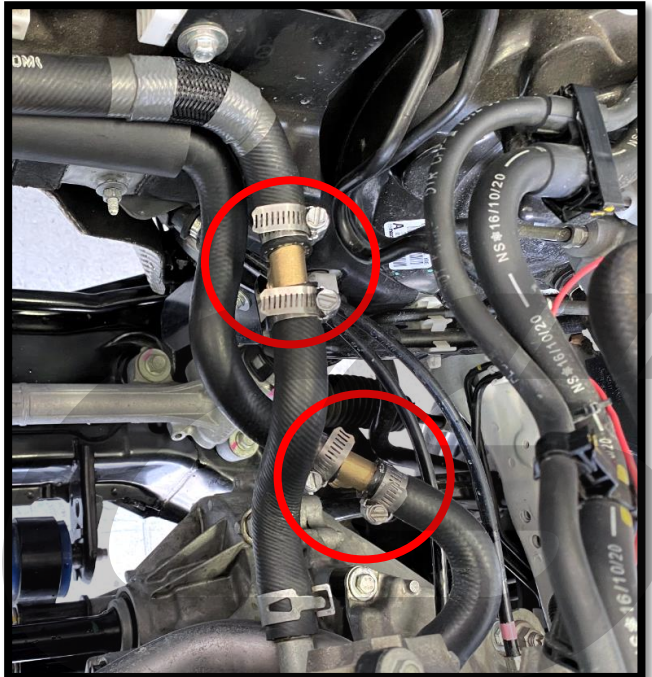


**Figure 8g**



**Figure 8h**

- m) Mark the coolant hoses as shown in **Figure 8h** with a sharpie or paint pen. Mark the each hose in the approximate center of the straight section as shown.



**Figure 8i**

- n) Cut the coolant hoses at the locations marked earlier using hose cutters or a razor blade.
- o) Insert the supplied coolant tee fittings into the cut OEM coolant hoses as shown in **Figure 8i**. Install the supplied clamps as well, keep loose for now.
- p) The coolant tee fittings will be connected to in a later step.

## DETAILED INSTRUCTIONS:

### 9. Turbocharger Pre-Install Setup



These images do not show the studs in the turbocharger for ease of understanding. Your turbocharger will come with manifold and downpipe studs pre-installed.

- a) **Locate the oil drain fitting, gasket and hardware.** The bolts are the longest M6 bolts that came in the turbocharger box. Components shown in **Figure 9a**.



Figure 9a

- b) **Locate the oil drain port on the turbocharger.** It is the large open port with two threaded holes on either side. Shown in **Figure 9b**.

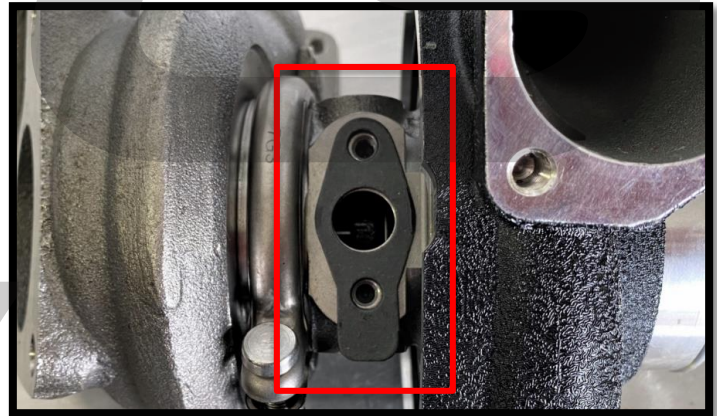


Figure 9b

- c) **Position the oil drain gasket onto the oil drain port of the turbocharger.** Shown completed in **Figure 9b**. Orientation of the gasket does not matter.

- d) **Attach the oil drain fitting to the turbocharger using the supplied hardware.** Tighten hardware to **12-15ft-lbs** using a 10mm socket and ratchet. Shown completed in **Figure 9c**.

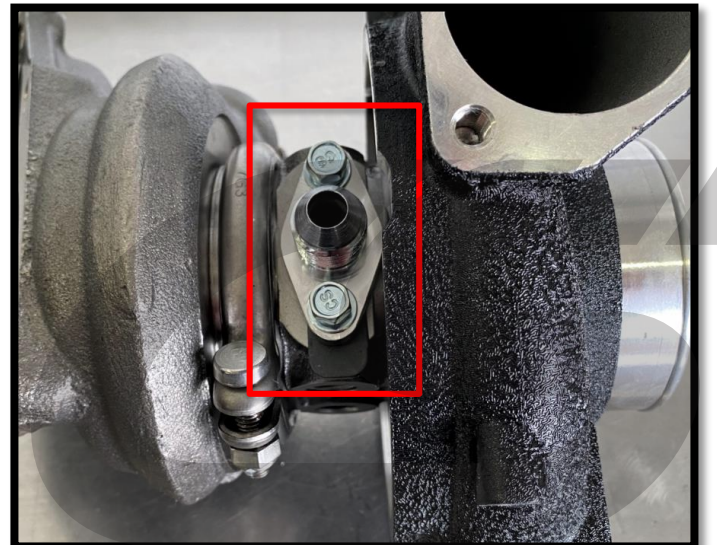


Figure 9c

## DETAILED INSTRUCTIONS:

### 9. Turbocharger Pre-Install Setup (continued)

- e) Position the turbocharger as shown and locate the coolant port circled in red in Figure 9d.
- f) For reference, all banjo bolts will be installed as shown in Figure 9e with a copper crush washer on EACH side of the banjo fitting.

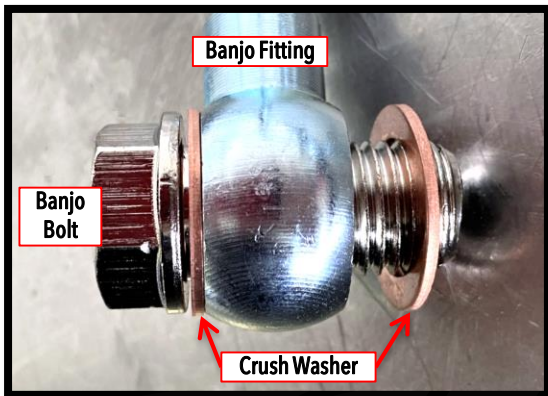


Figure 9e

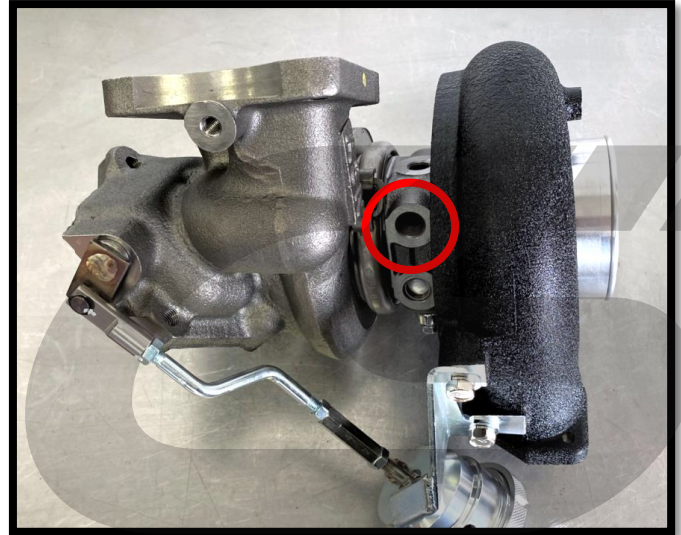


Figure 9d

- g) Locate the "S" shaped coolant hardline. Position this line onto the coolant port in Figure 9d and secure with one of the supplied large banjo bolts and two large copper crush washers. Only thread the banjo bolt a few turns for now. Shown completed and circled in red in Figure 9f.
- h) Using one of the supplied short M6 bolts, secure the coolant hardline to the mounting location on the compressor housing. Only install this M6 bolt a few turns for now. Shown completed and circled in blue in Figure 9f.
- i) Then, tighten the banjo bolt with a 17mm socket and ratchet to 20ft-lbs.
- j) Finally tighten the M6 bolt securing the coolant line until snug.



Figure 9f

## DETAILED INSTRUCTIONS:

### 9. Turbocharger Pre-Install Setup (continued)

- k) Position the turbocharger as shown and locate the coolant port **circled in red** in **Figure 9g**.
  
- l) Locate the "U" shaped coolant hardline. Position this line **onto the coolant port** in **Figure 9g** and secure with one of the supplied large banjo bolts and two large copper crush washers. Only thread the banjo bolt a few turns for now. Shown completed and **circled in red** in **Figure 9h**.
  
- m) Using one of the supplied short M6 bolts, secure the coolant hardline to the mounting location on the compressor housing. Only install this M6 bolt a few turns for now. Shown completed and **circled in blue** in **Figure 9h**.
  
- n) Then, tighten the banjo bolt with a 17mm socket and ratchet to **20ft-lbs**.
  
- o) Finally tighten the M6 bolt securing the coolant line until snug.

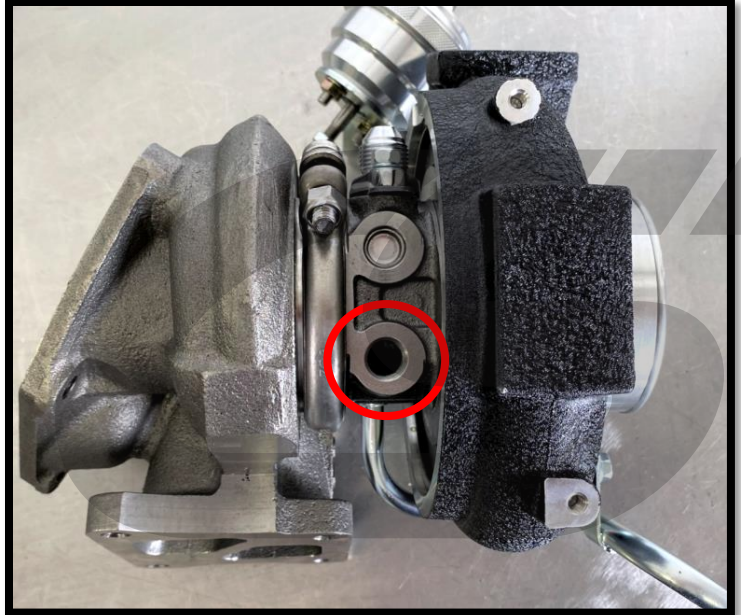


Figure 9g

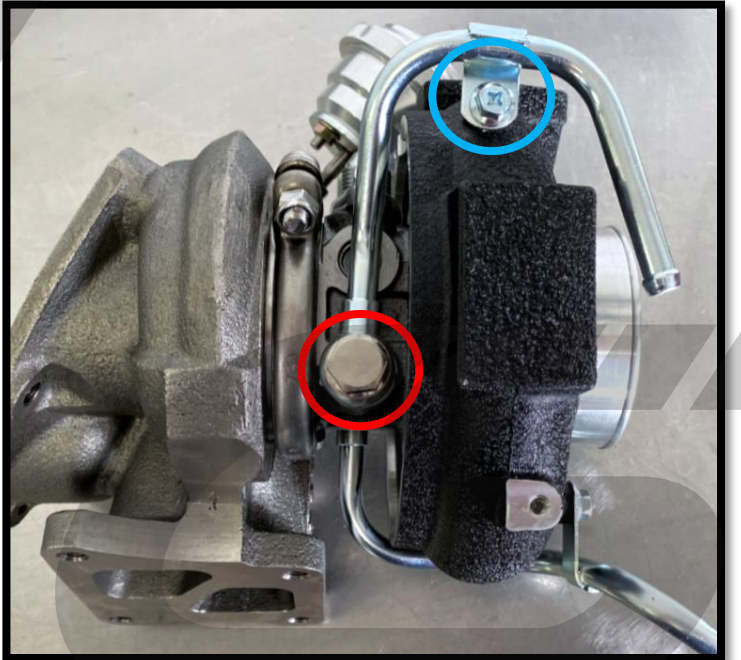
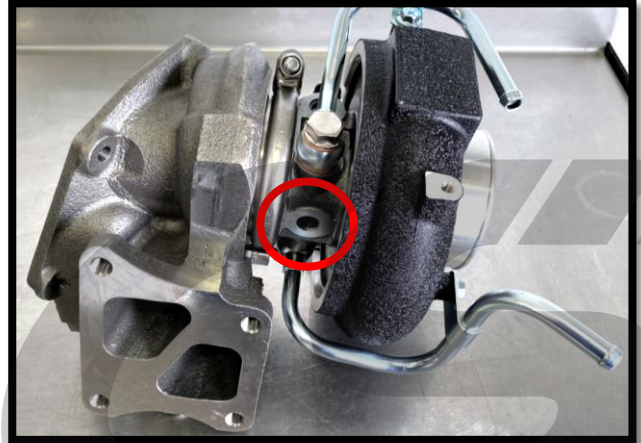


Figure 9h

## DETAILED INSTRUCTIONS:

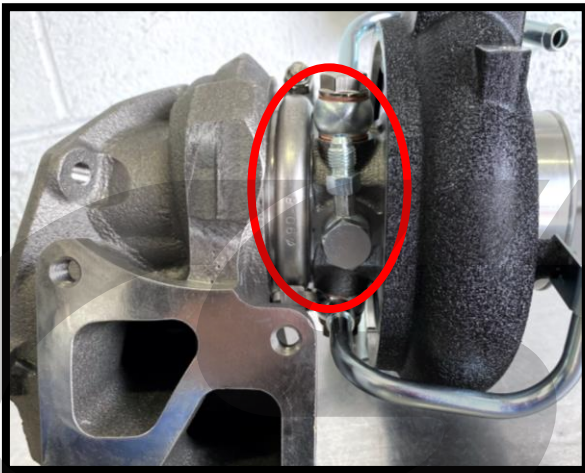
### 9. Turbocharger Pre-Install Setup (continued)

- p) Position the turbocharger as shown and locate the oil feed port **circled in red** in **Figure 9i**.



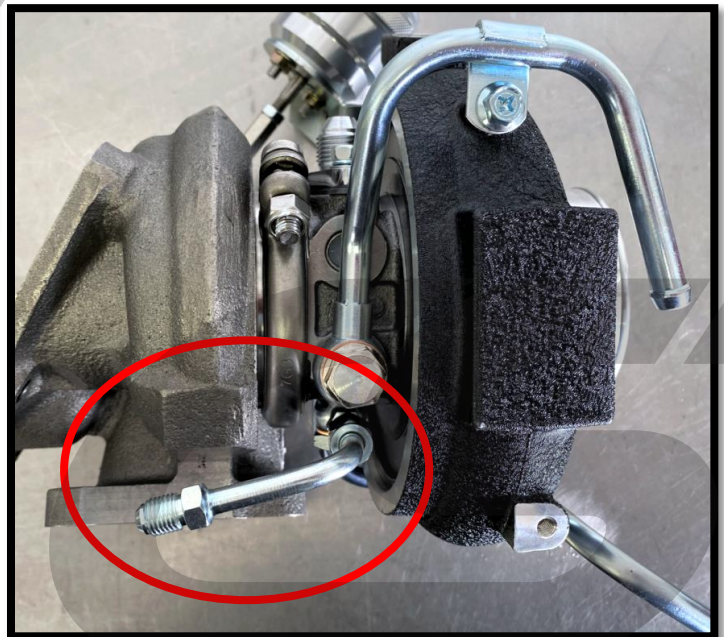
**Figure 9i**

- q) Locate the banjo to AN fitting. Position this fitting onto the oil feed port in **Figure 9i** and secure with the supplied small banjo bolt and two small copper crush washers. Tighten the banjo bolt to **15ft-lbs** with a 19mm socket and ratchet while ensuring the orientation matches **Figure 9j** **circled in red**.



**Figure 9j**

- r) Locate the 90° AN to AN fitting. Position this fitting onto the banjo fitting secured in the previous step. Tighten the AN to AN fitting until snug using a 14mm wrench. Ensure the orientation matches **Figure 9k** **circled in red**.



**Figure 9k**

## DETAILED INSTRUCTIONS:

### 9. Turbocharger Pre-Install Setup (continued)

- s) Position the turbo to manifold gasket over the four pre-installed studs as shown in **Figure 9l**.
- t) Place the manifold onto the turbocharger studs and secure with four of the supplied crimp nuts and dual layer serrated washers. Shown secured and **shown in red** in **Figure 9n**.
- u) Tighten the turbocharger to manifold nuts to **45-50ft-lbs** with a 14mm wrench or socket & ratchet.



**Figure 9l**



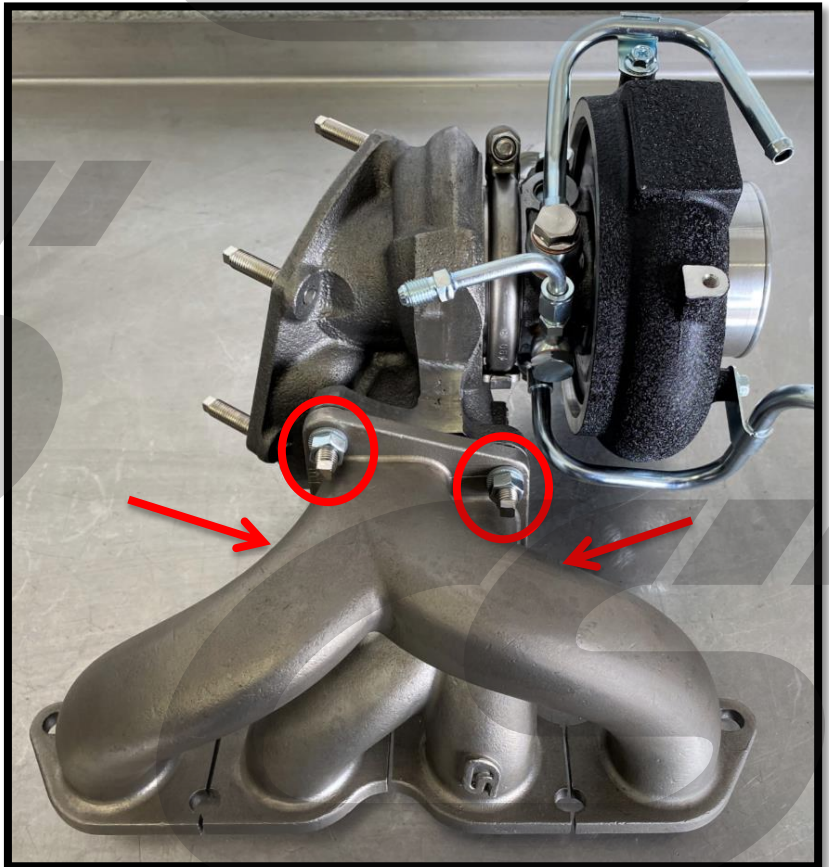
Both gasket & manifold can only install in one orientation.



The washers used when connecting the turbo to the manifold are a special "dual layer" design. **DO NOT** separate the layers. They should appear and be installed as shown in **Figure 9m** below.



**Figure 9m**

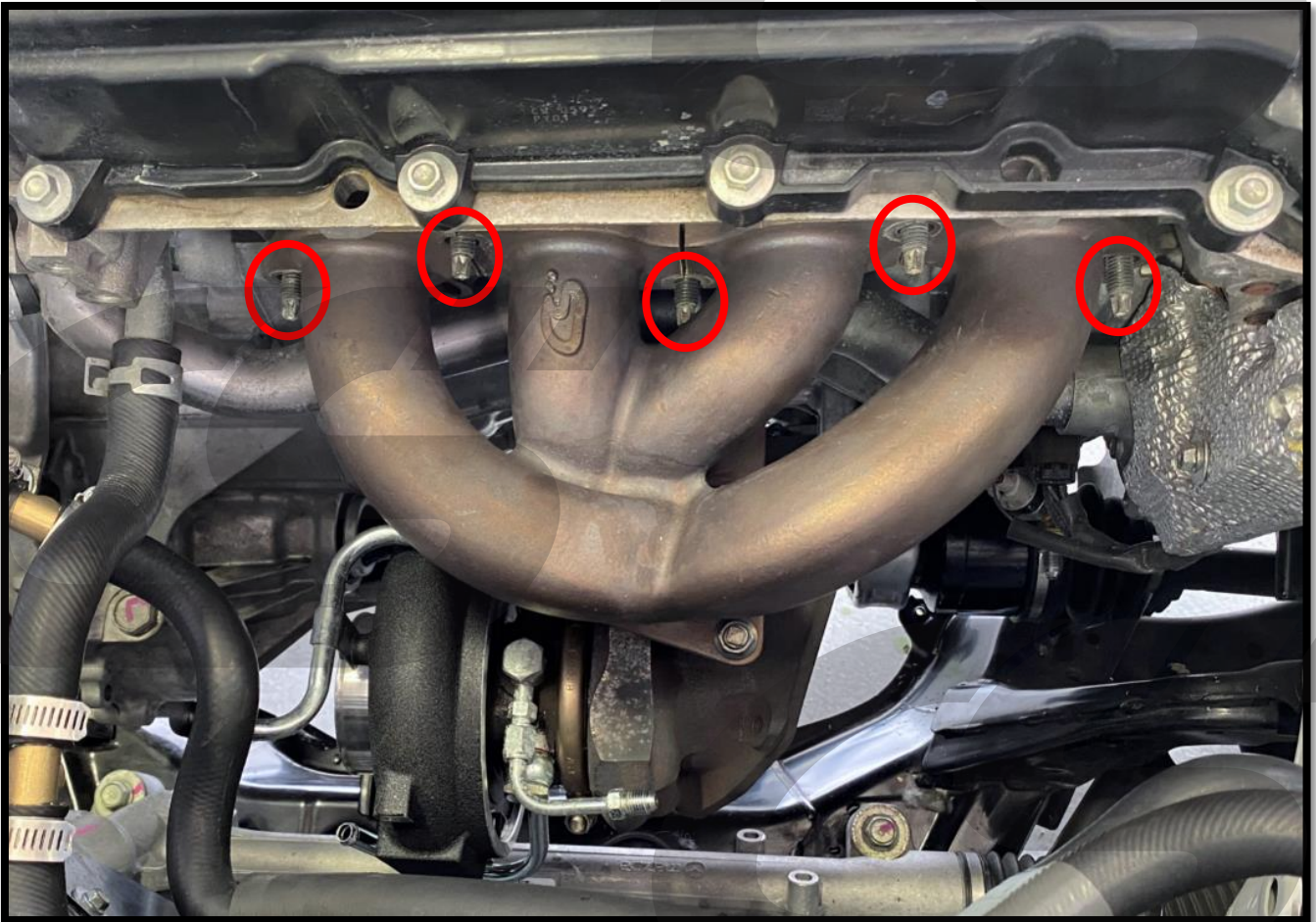


**Figure 9n**

## **DETAILED INSTRUCTIONS:**

### **10. Turbocharger Installation & Plumbing**

- a) **Inspect your exhaust manifold gasket to ensure a good exhaust seal.** If the gasket is at all bent or showing signs of corrosion, we recommend replacing the gasket. OEM Mazda part number is PY01-13-460.
  
- b) **Lift the exhaust manifold and turbocharger assembly into to vehicle from the top.** Position the manifold over the studs and push it against the head of the vehicle. Hand tighten the five OEM exhaust manifold nuts removed earlier to keep the manifold secure. Shown installed in **Figure 10a** with nut locations **circled in red**.

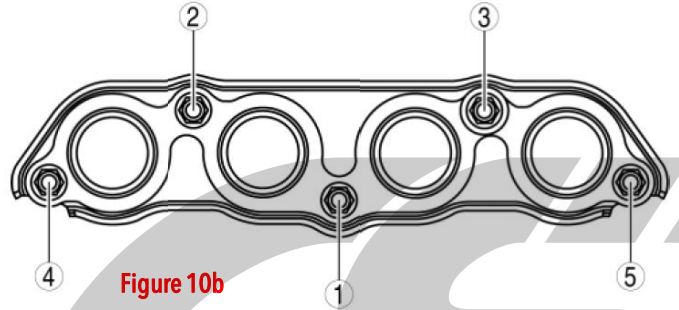


**Figure 10a**

## DETAILED INSTRUCTIONS:

### 10. Turbocharger Installation & Plumbing (continued)

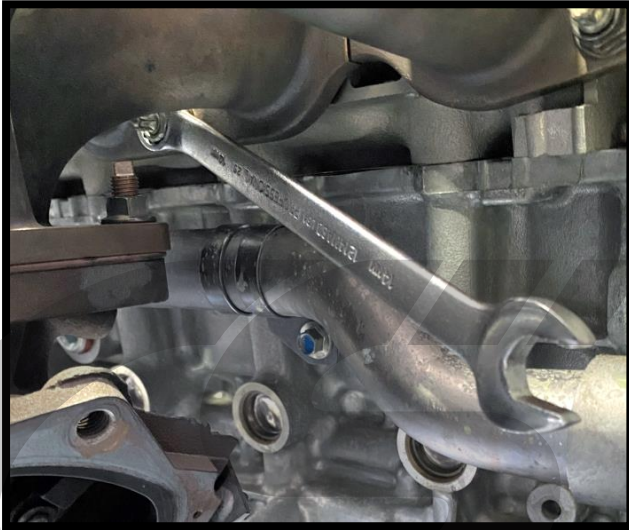
- c) Tighten the 14mm nuts as shown in **Figure 10b**. Start by tightening position 1 and 2 in order to **25-30ft-lbs**.
- d) Then tighten positions 3, 4, and 5 to **40-45ft-lbs**. Finally, tighten positions 1 and 2 to **40-45ft-lbs**.



**Figure 10b**



The following images are a guide for tightening the turbocharger manifold mounting nuts, including the basic tools we recommend for tightening.



**Position 1:** Basic 14mm wrench, access from under car or reach underneath manifold from passenger side



**Position 2:** Basic 14mm wrench. Open end allows for more rotation during initial tightening but we recommend closed end for final torquing.

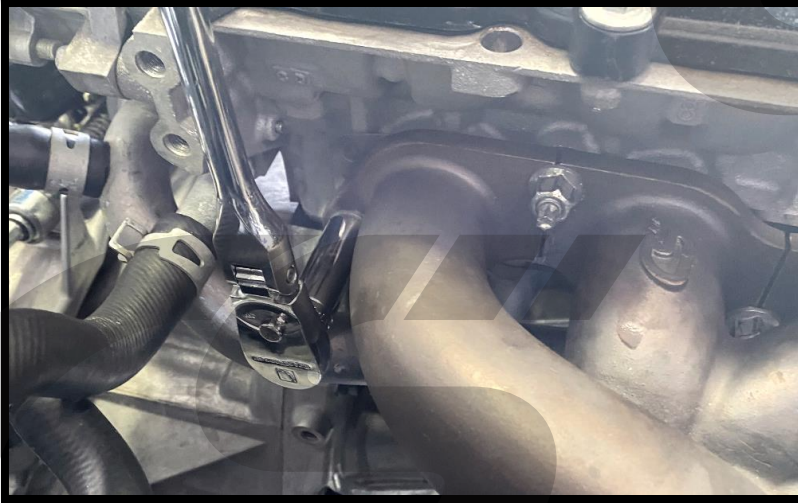


**DETAILED INSTRUCTIONS:**

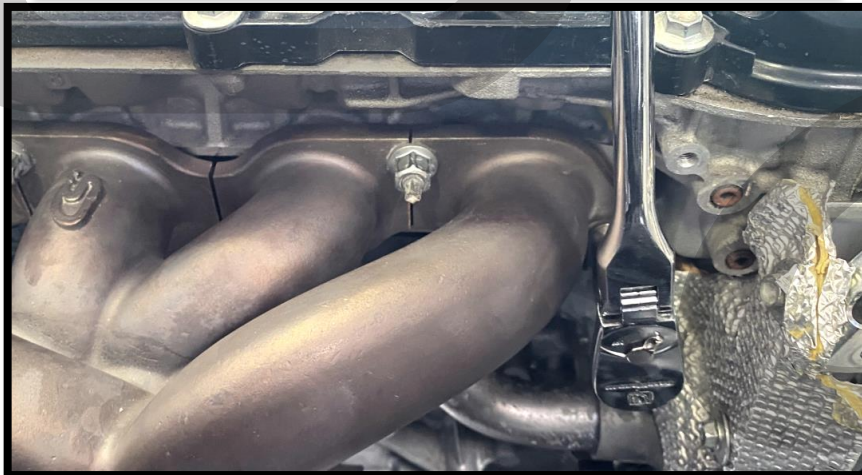
**10. Turbocharger Installation & Plumbing (continued)**



**Position 3:** Basic 14mm wrench. Open end allows for more rotation during initial tightening but we recommend closed end for final torquing.



**Position 4:** Deep 14mm socket & ratchet

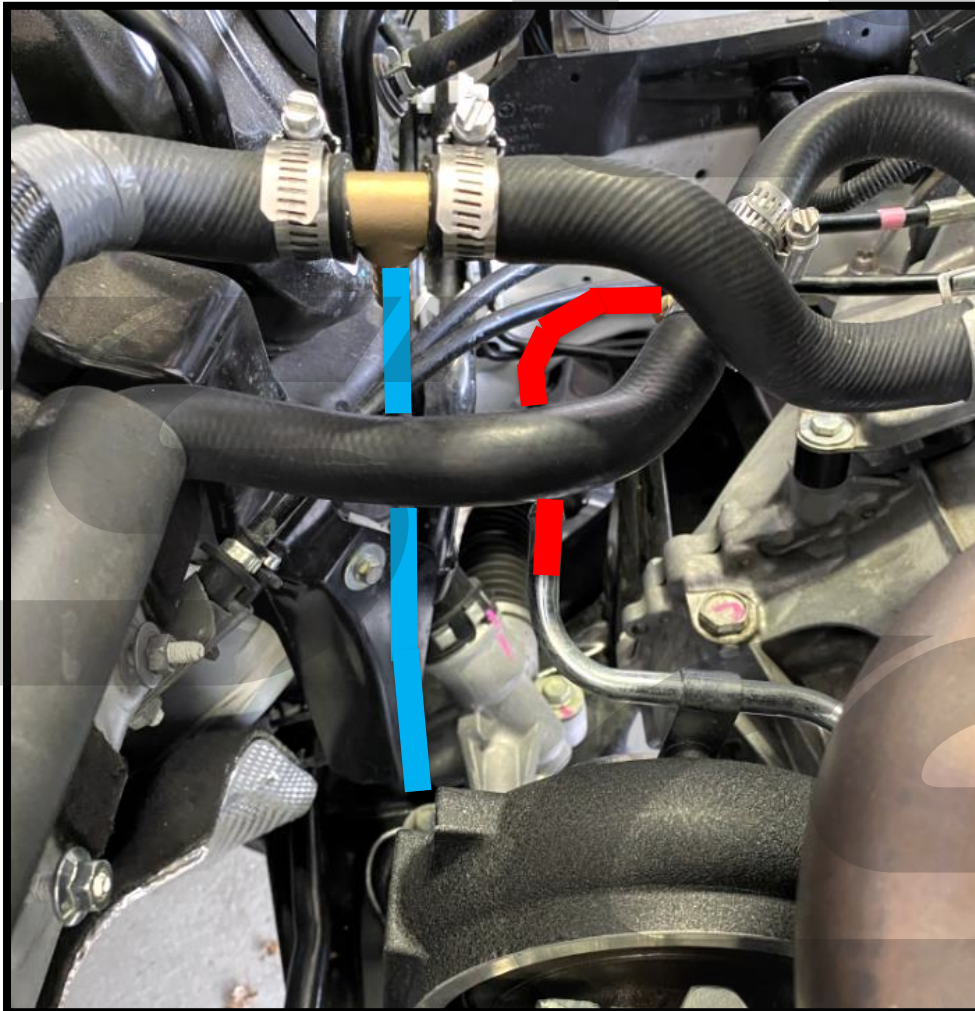


**Position 5:** Deep 14mm socket & ratchet

## **DETAILED INSTRUCTIONS:**

### **10. Turbocharger Installation & Plumbing (continued)**

- e) **Locate the supplied 10mm ID silicone hose.** Cut one section of the hose to 5.5" in length. Cut another section of hose to 11" in length.
- f) **Attach the 5.5" long hose between the lower coolant hose tee setup earlier and the upper coolant pipe on the turbocharger.** Approximate routing shown with **red lines** in **Figure 10c**. Rotate the tee fitting as needed for best hose routing.
- g) **Attach the 11" long hose between the upper coolant hose tee setup earlier and the lower coolant pipe on the turbocharger.** Approximate routing shown with **blue lines** in **Figure 10c**. Rotate the tee fitting as needed for best hose routing.

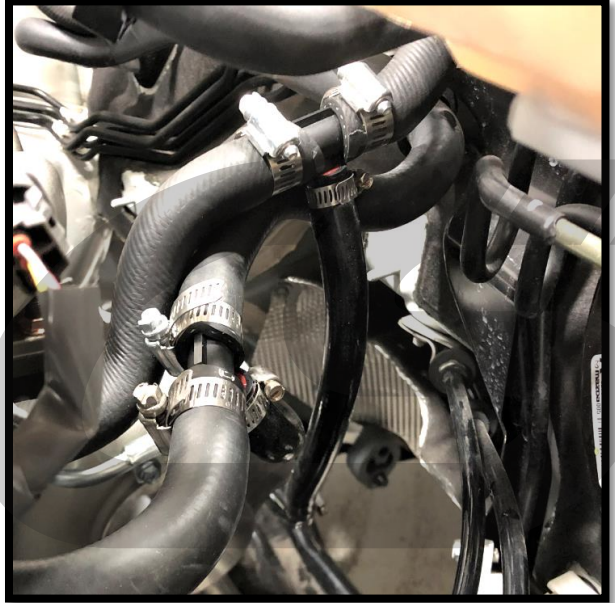


**Figure 10c**

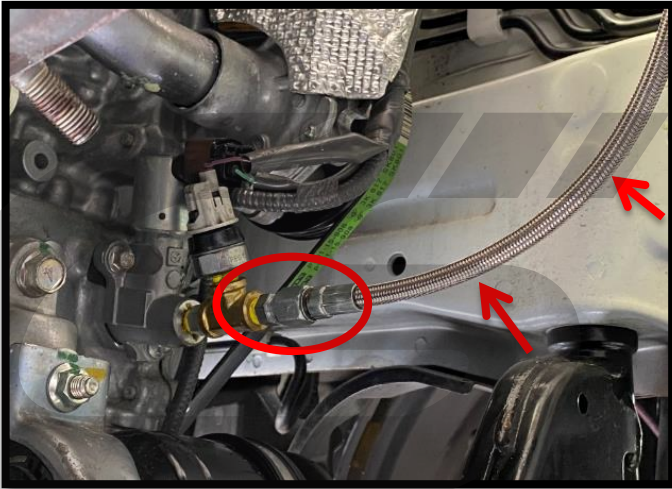
## **DETAILED INSTRUCTIONS:**

### **10. Turbocharger Installation & Plumbing (continued)**

- h) Once happy with routing, install the remaining supplied hose clamps and tighten all coolant hose clamps with a flathead screwdriver. Ensure the hoses are not touching any sharp edges of the clamps. Shown completed in **Figure 10d**.
- i) Locate the oil feed line in your turbo kit. Install one end onto the oil feed tee assembly you setup earlier. Tighten it until snug using a 14mm wrench. Route the other end out of the way until a later step. Shown completed in **Figure 10e**.

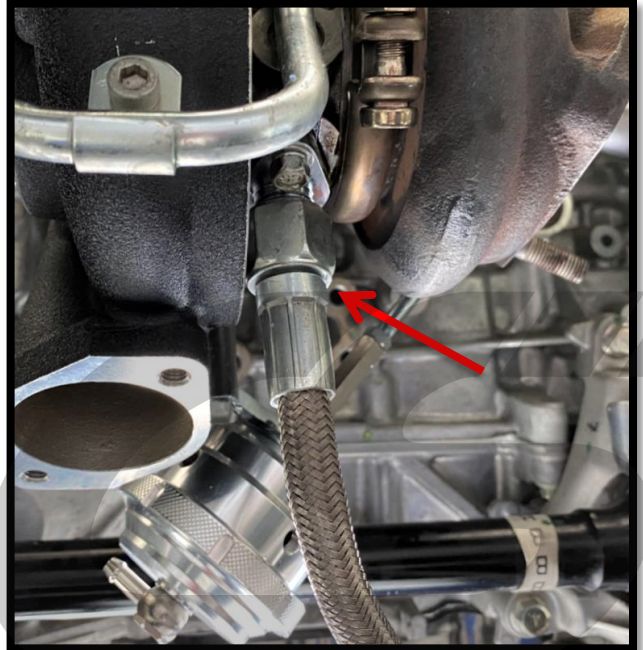


**Figure 10d**



**Figure 10e**

- j) Locate the oil drain line in your turbo kit. Install the straight end onto the oil drain fitting you installed onto the turbo earlier. Only hand tighten for now. Shown in **Figure 10f**.

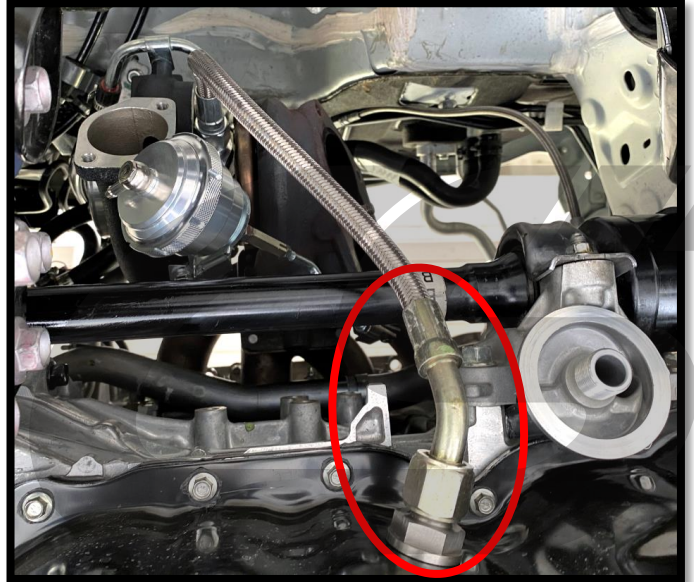


**Figure 10f**

## **DETAILED INSTRUCTIONS:**

### **10. Turbocharger Installation & Plumbing (continued)**

- k) Install the angled end of the oil drain line onto the oil drain fitting that was pre-installed in your new oil pan. Only hand tighten for now. Shown in **Figure 10g**.



**Figure 10g**

### **11. Downpipe Installation**

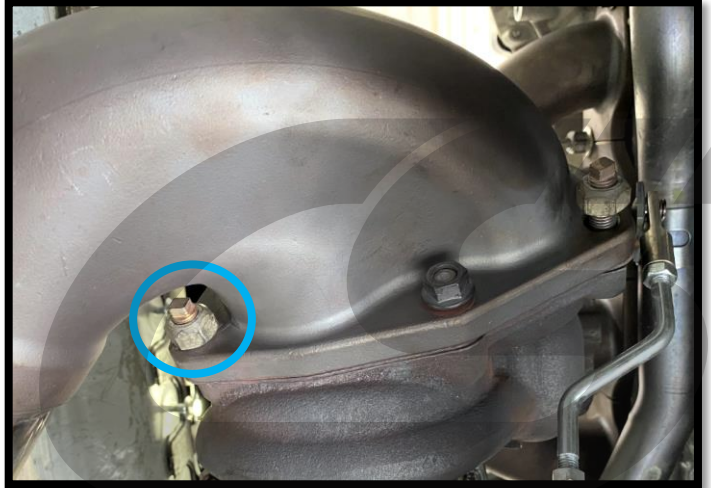
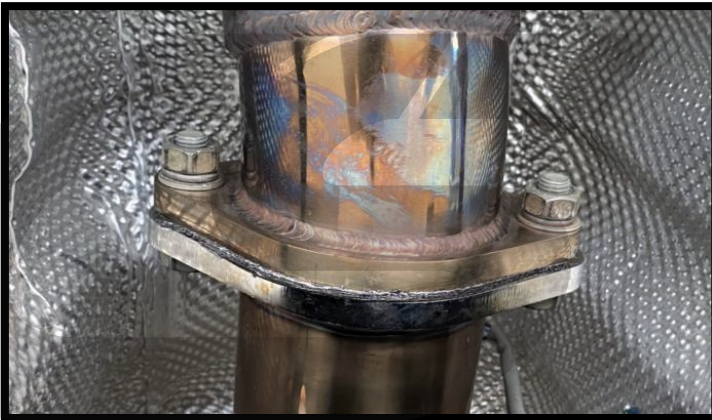
- a) Position the turbo to downpipe gasket over the pre-installed studs as shown in **Figure 11a**.



**Figure 11a**

**DETAILED INSTRUCTIONS:****11. Downpipe Installation (continued)**

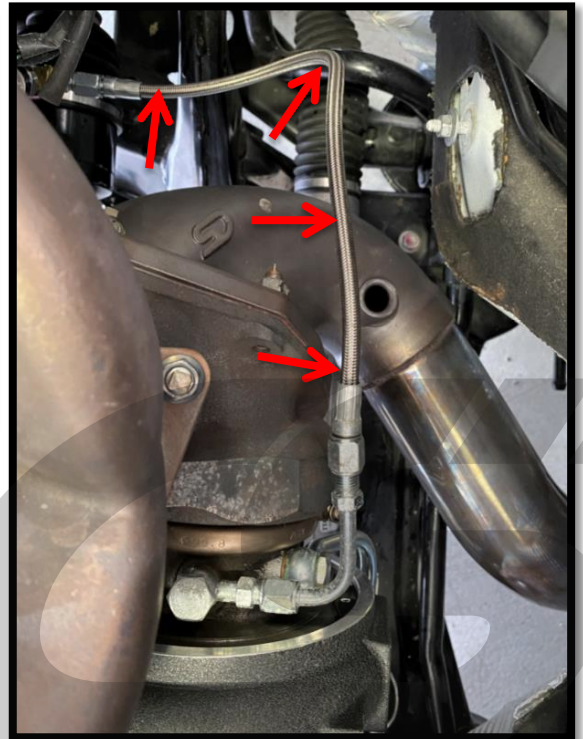
- b) Place the downpipe onto the turbocharger studs and secure with the remaining five supplied crimp nuts and dual layer serrated washers. Start with the nut location shown circled in blue in **Figure 11b**.
- c) Tighten the turbocharger to manifold nuts to **45-50ft-lbs** with a 14mm wrench or socket & ratchet.
- d) Install the supplied exhaust crush gasket in between the downpipe outlet flange and your midpipe. Use the supplied gold M10 hardware and secure the downpipe to your exhaust as shown in **Figure 11c**. Only tighten to **20-25ft-lbs** to ensure the gasket operates correctly.

**Figure 11b****Figure 11c**

- e) Attach the remaining end of the oil feed line to the oil feed fitting on the turbocharger. Shown loosely in position in **Figure 11d**. Tighten until snug using a 14mm wrench.



The oil feed line should have plenty of gap above the downpipe (2-3 inches). If at all close to the downpipe, loosen the feed line and reposition.

**Figure 11d**

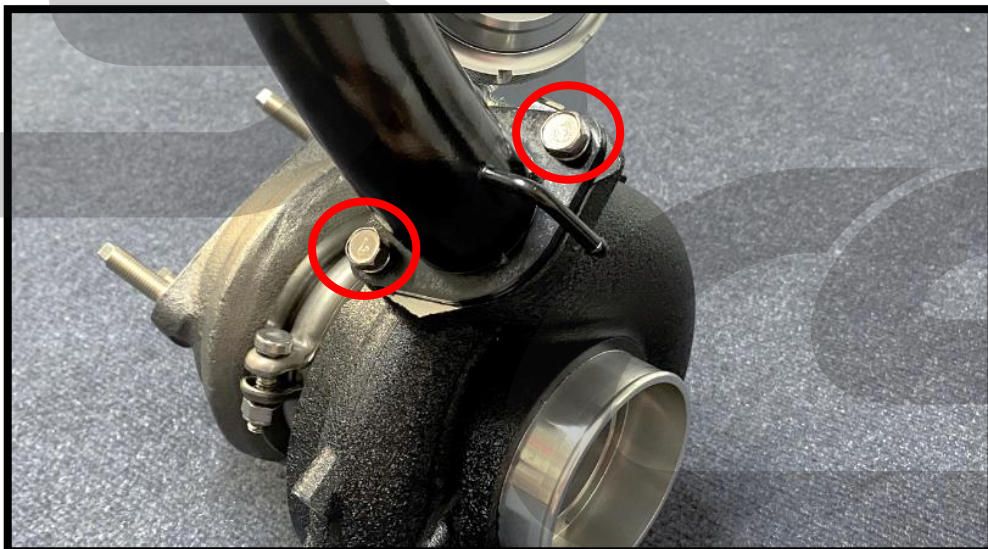
## **DETAILED INSTRUCTIONS:**

### **12. Hot Side Intercooler Piping Installation**

- a) Locate the compressor outlet pipe and gasket that came with your turbocharger kit. Shown in **Figure 12a**.
- b) Secure the compressor outlet pipe to the outlet of the turbo using the supplied M8 hardware and tighten until snug using a 12mm socket and ratchet. Shown completed off the vehicle for clarity in **Figure 12b**. Ensure the small barb fitting is on the same side as the compressor inlet as shown.



**Figure 12a**



**Figure 12b**

## DETAILED INSTRUCTIONS:

### 12. Hot Side Intercooler Piping Installation (continued)

c) Position the oil drain line so that there is approximately a 1/4" gap between the drain line and the compressor outlet pipe as shown with blue circle in Figure 12c. Then, tighten both of the oil drain line end fittings until snug using an adjustable wrench.

d) Locate the compressor outlet silicone. It is an approximately 60° bend with one small end and one large end.

e) Slide the small end of the compressor outlet silicone over the compressor outlet tube as shown in Figure 12d. Ensure a supplied 51-59mm clamp is positioned loosely on the small end, and a 63-71mm clamp is positioned loosely on the large end as shown.



Figure 12c



Figure 12d

## DETAILED INSTRUCTIONS:

### 12. Hot Side Intercooler Piping Installation (continued)

- f) Locate the A/C compressor at the front of engine. Remove the lower two 12mm mounting bolts circled in red in **Figure 12e**.



Figure 12e



Some vehicles have an additional wiring bracket attached at this location as shown below in **Figure 12f**. The bracket must be removed for turbo kit installation. **If you do not have the additional wiring bracket, you can skip to the next page.**

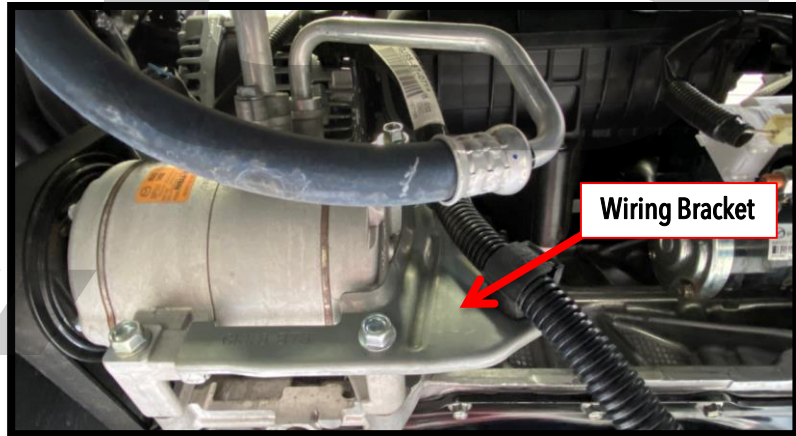


Figure 12f

- g) Remove the two clips from the backside of the wiring bracket to free the wire harness from the bracket. Squeeze the clips as shown in **Figure 12g** to free the wiring. Then remove the wiring bracket from the vehicle. The bracket is not needed and the wiring will float in the engine bay without issue.

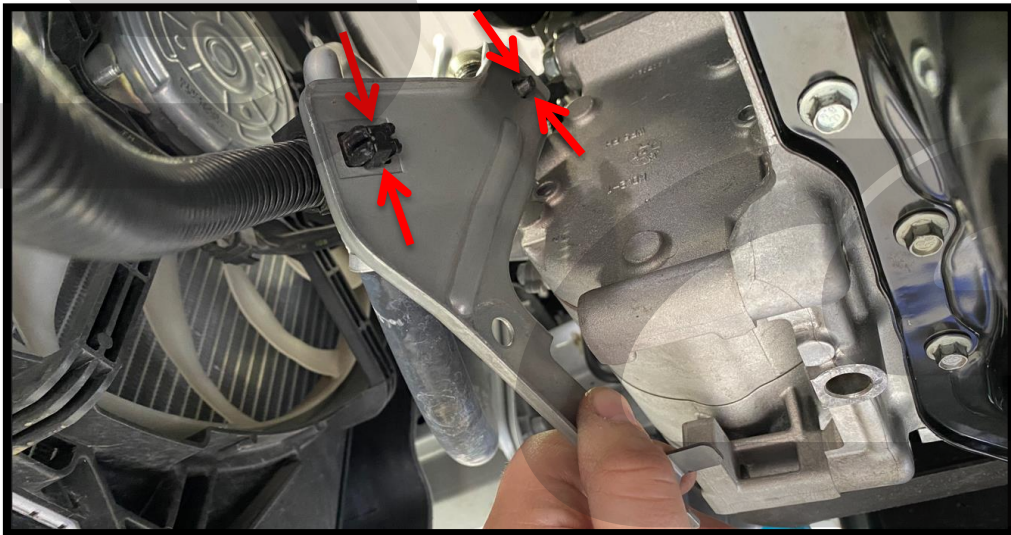
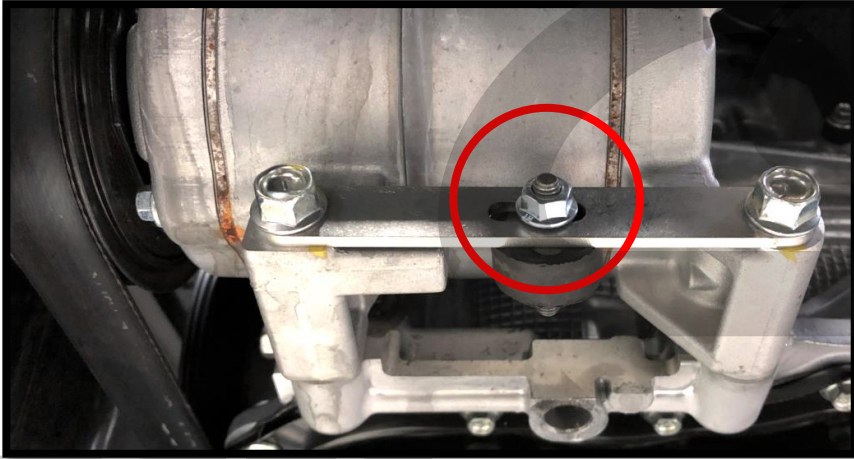


Figure 12g



**DETAILED INSTRUCTIONS:****12. Hot Side Intercooler Piping Installation (continued)**

- h) Install the supplied mounting bracket as shown in **Figure 12h** and secure with the OEM hardware. Tighten the bolts to **15-18ft-lbs.**
- i) Install the supplied rubber isolator into the mounting bracket and loosely secure with a supplied M6 nut. Shown **circled in red** in **Figure 12h.**

**Figure 12h**

- j) Locate the axle support bracket near the oil filter. Remove the lower mounting nut using a 12mm socket & ratchet. Shown **circled in red** in **Figure 12i.**

**Figure 12i**

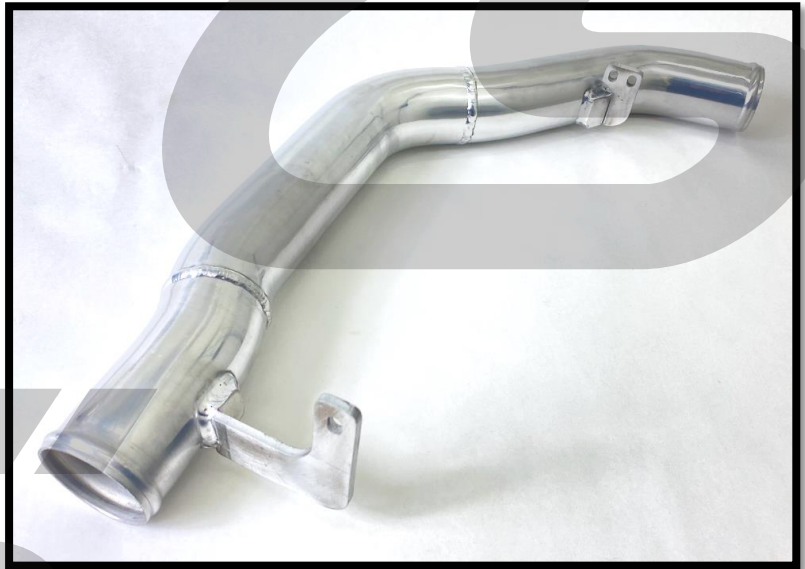
## **DETAILED INSTRUCTIONS:**

### **12. Hot Side Intercooler Piping Installation (continued)**

- k) **Locate the hot side intercooler pipe, bracket, & spacer.** Bracket and hardware shown in **Figure 12j**, pipe shown in **Figure 12k**. The hot side pipe has two mounting brackets welded to it.
- l) **Attach the spacer and bracket to the hot side intercooler pipe as shown using supplied M6x20mm bolts and M6 flange nuts.** For Manual Transmission, ensure the orientation matches what is shown in **Figure 12l**, with spacer and bracket forward of the attachment point on the pipe. For Automatic Transmission, reverse the orientation, as shown in **Figure 12m**. Leave the hardware hand tight for now.



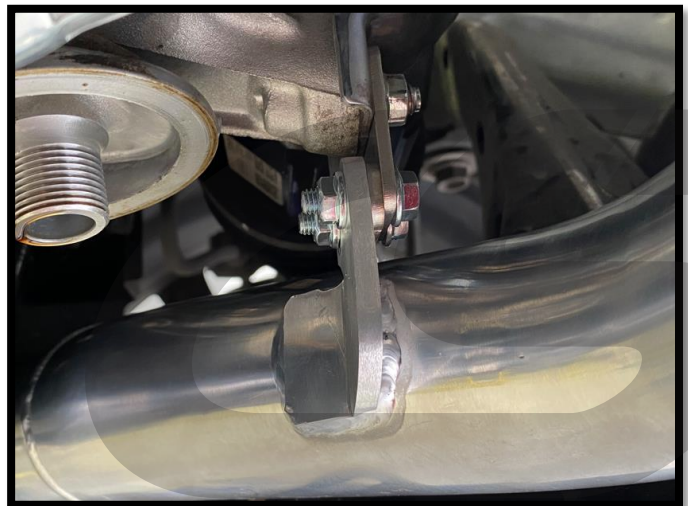
**Figure 12j**



**Figure 12k**



**Figure 12l**

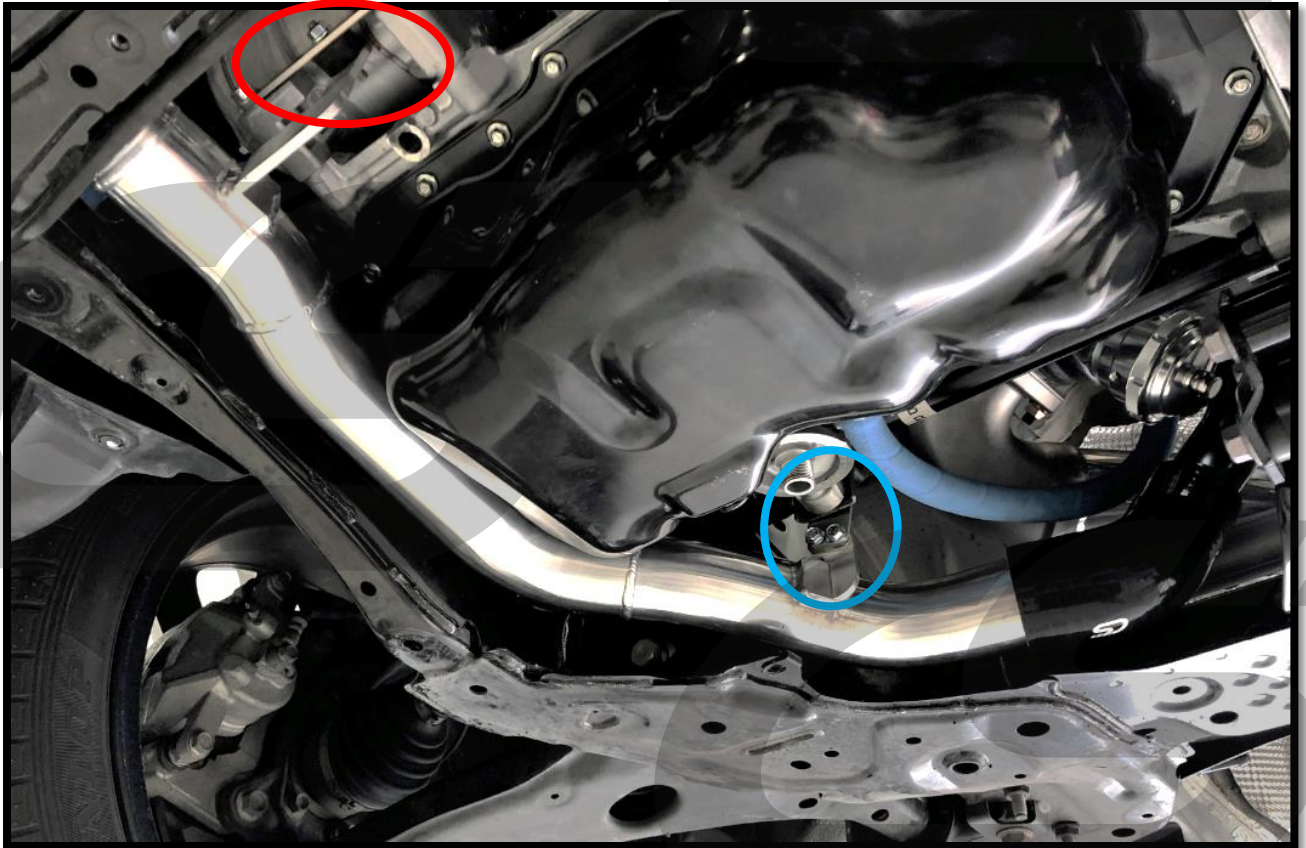


**Figure 12m**

## **DETAILED INSTRUCTIONS:**

### **12. Hot Side Intercooler Piping Installation (continued)**

- m) **Lift the hot side pipe into the engine bay.** It fits in the gap between the oil pan and the passenger side frame rail. Slide it into the compressor outlet silicone, then fit the forward bracket onto the rubber isolator stud in the front, and the axle support bracket in the rear. Shown in position in **Figure 12n.**
- n) **Once in position, secure the front bracket with one of the supplied M6 nuts.** Location **circled in red** in **Figure 12n.**
- o) **Secure the rear bracket with the OEM nut removed from the axle support bracket earlier.** Location **circled in blue** in **Figure 12n.**
- p) **Shift the pipe around until there is even clearance all around the pipe and the brackets are sitting vertical.** Then tighten M6 mounting hardware with a 10mm wrench until snug. Finally tighten 12mm nut on the axle support bracket to **17-20ft-lbs.**



**Figure 12n**

## DETAILED INSTRUCTIONS:

### 12. Hot Side Intercooler Piping Installation (continued)

- q) Line up the two clamps on the compressor outlet silicone and then tighten using a 10mm deep socket and ratchet. When clamps are tight, the silicone will bulge slightly around the edges of the clamps. Shown completed in **Figure 12o**.
- r) At this time, you can install a fresh oil filter. The area around the oil filter no longer needs the extra room for positioning components.
- s) Locate the hot side intercooler silicone. It is a ~1ft. long tube with an "S" shaped bend in the center.
- t) Place the hot side intercooler silicone over the end of the hot side intercooler pipe. The side of the silicone with the "bulge" will fit over the intercooler pipe. The "S" shaped bend fits over the subframe and under the radiator as shown in **Figure 12p**. Loosely install a 63-71mm clamp on the hot pipe end. Shown completed in **Figure 12q**.

NOTE

If the "bulge" in the silicone is not obvious, the "CS" logo sits toward the front of the vehicle as shown.



Figure 12o

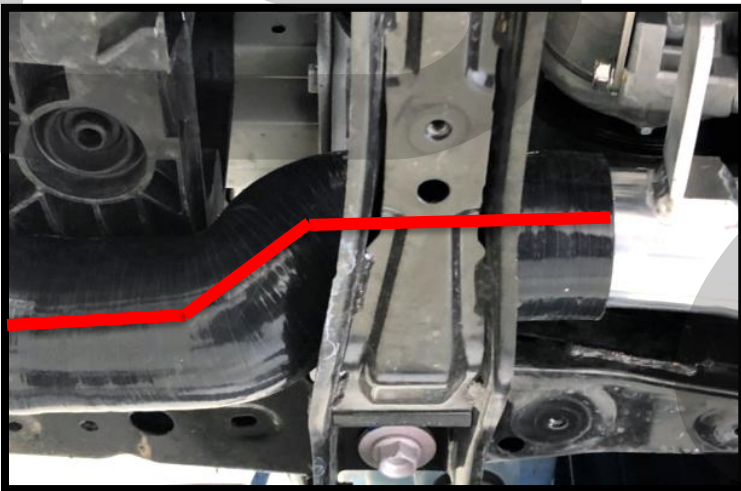


Figure 12p

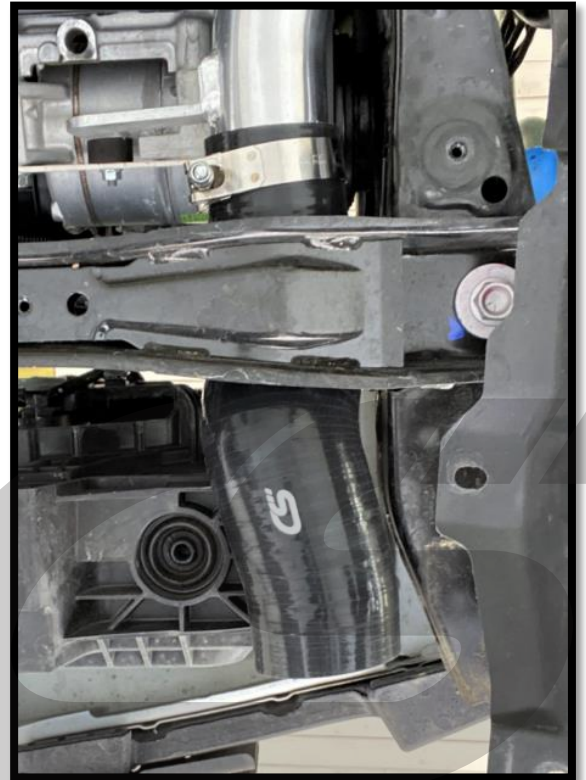


Figure 12q

**DETAILED INSTRUCTIONS:**

---



**CONGRATULATIONS YOU MADE IT TO PAGE 69!**

***...NICE***

## DETAILED INSTRUCTIONS:

### 13. Intercooler Installation

- a) Install the intercooler endtank brackets loosely onto the intercooler. Use the supplied hardware in the intercooler box, only threaded in a few turns. Driver's side of intercooler and driver's side bracket shown installed in **Figure 13a**.
  
- b) Remove the two lower crashbar mounting bolts using a 10mm socket and ratchet. Shown **circled in red** in **Figure 13b** and **Figure 13c**. Keep these bolts handy, they will be used soon.



**Figure 13a**

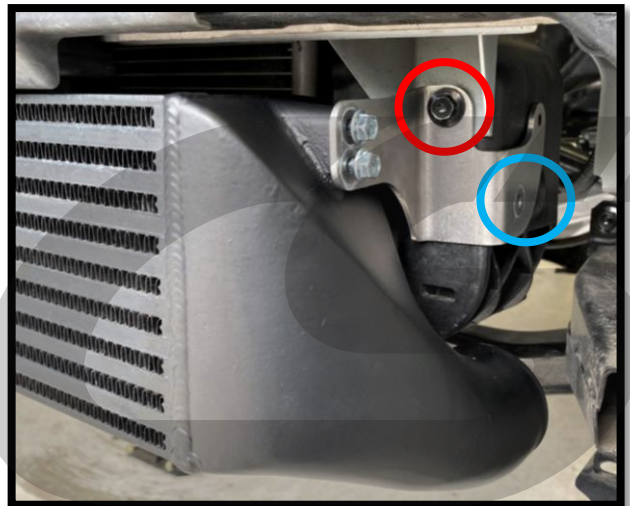


**Figure 13b**

**NOTE**

Having a friend help you with this next step is recommended.

- c) Lift the intercooler with brackets up to the front of the vehicle. Insert the passenger side of the intercooler into the hot side silicone installed earlier. Silicone shown **circled in blue** in **Figure 13b**.
  
- d) Line up the holes in the intercooler brackets with the **threaded crashbar holes**. Secure the intercooler in these locations using the OEM hardware. Finger tighten hardware. Driver's side shown completed in **Figure 13c**.

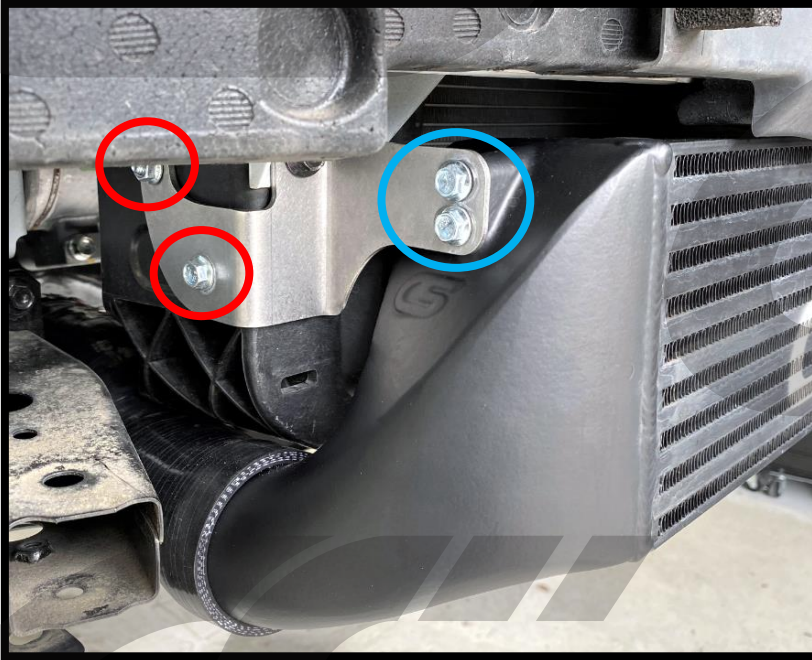


**Figure 13c**

## DETAILED INSTRUCTIONS:

### 13. Intercooler Installation (continued)

- e) Using the supplied hardware, connect the remaining holes in the intercooler brackets to the radiator core support. The driver's side only has one location, shown circled in blue in **Figure 13c** on the previous page. The passenger side has two locations, shown circled in red in **Figure 13d**.



**Figure 13d**



If struggling to feed the bolts or nuts into the core support, using a piece of tape on a wrench to feed the bolt/nut in makes it easy. Shown in **Figure 13e**.



**Figure 13e**

- f) Once all bolts are hand tight, begin final tightening, starting with the OEM crashbar bolts. Tighten until snug, then move onto the bolts installed in the previous step.
- g) Shift the intercooler around as needed for good clearance and to ensure the intercooler is sitting level, then tighten the final bolts that secure the intercooler to the brackets. One side shown circled in blue in **Figure 13d**.



We have found that pulling the intercooler towards the front of the vehicle offers the best fitment. There are adjustment slots in the brackets to allow this movement.



The top of the intercooler may slightly touch some foam on the OEM crashbar. This is OK and will not cause any problems.

## DETAILED INSTRUCTIONS:

### 13. Intercooler Installation (continued)

- h) Moving to the hot side intercooler silicone, shift and rotate it as needed until you have good clearances all around the silicone. It is OK if the silicone touches the subframe or radiator core support slightly, but, no sharp edges can touch the silicone or it could be damaged.
- i) Once happy with fitment, align & tighten the 63-71mm clamp installed in Step 12p. When clamps are tight, the silicone will bulge slightly around the edges of the clamps. Shown completed in **Figure 13f.**



**Figure 13f**



**Figure 13g**

- j) Remove the nut from a supplied 70-78mm clamp. Feed the clamp in between the intercooler and core support as shown in **Figure 13g.**
- k) Position the clamp on the end of the intercooler and with the threaded portion facing toward the center of the vehicle as shown in **Figure 13h.** Once happy with fitment, tighten the clamp. Once tight, the silicone will bulge slightly around the edges of the clamp.



**Figure 13h**



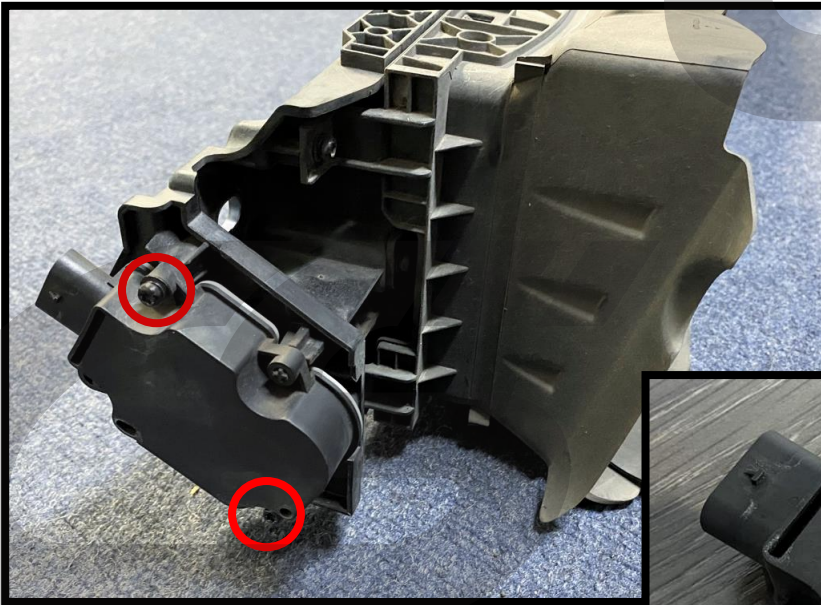
## **DETAILED INSTRUCTIONS:**

### **13. Intercooler Installation (continued)**



If your vehicle did not have an air shutter assembly, skip to Section 14 on the next page.

- l) **Remove the radiator shutter motor from the radiator shutter removed earlier.** Use a T20 Torx socket to remove the two bolts holding the motor to the radiator shutter. Shown **circled in red** in **Figure 13i**. Motor shown removed in **Figure 13j**.
- m) **Reconnect the radiator shutter motor to the wiring harness it was unplugged from earlier.**
- n) **Zip tie the radiator shutter motor to the radiator core support where it is out of the way and secure.** This is done to ensure no connectivity errors with other portions of the car if we were to leave this motor completely disconnected.



**Figure 13i**



**Figure 13j**

## **DETAILED INSTRUCTIONS:**

### **14. Cold Side Intercooler Piping Installation**

- a) **Locate the cold side silicone elbow.** It is an approximately 80° bend where one end has a “bulge”.
- b) **Slide the non-bulged end of the cold side silicone over the end of the intercooler** as shown in **Figure 14a**. It will fit tightly between the radiator core support and the subframe as shown. Angle the other end slightly towards the center of the vehicle.

**NOTE** If the “bulge” in the silicone is not obvious, the “CS” logo sits toward the front of the vehicle as shown.



**Figure 14a**



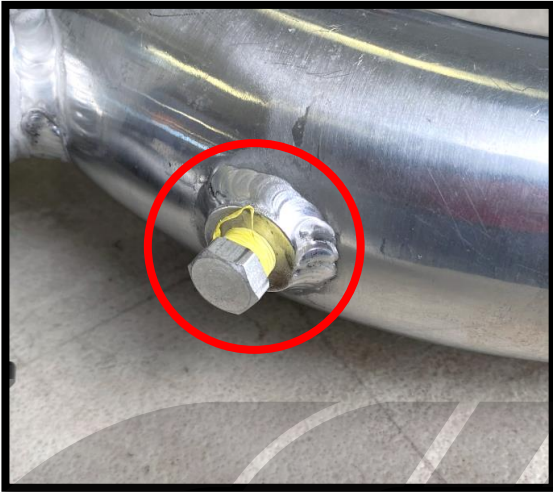
**Figure 14b**

- c) **Locate the throttle body silicone.** It is a ~3.5” long straight coupler with one large end, one small end, and a hump in the middle.
- d) **Install the large end of the throttle body silicone over the OEM throttle body.** Install it with one 77-85mm clamp on the larger, throttle body side, and one 70-78mm clamp on the smaller side. Shown in **Figure 14b**.
- e) **Ensure the throttle body silicone is fully seated onto the OEM throttle body, then tighten the 77-85mm clamp.** Once tight, the silicone will bulge slightly around the edges of the clamp.

## DETAILED INSTRUCTIONS:

### 14. Cold Side Intercooler Piping Installation (continued)

- f) Locate the NPT plug that was set aside in Step 8f. Apply fuel/oil safe PTFE thread tape or sealant to the NPT threads of the plug and install it into the open port on the cold side intercooler pipe. Tighten hand tight, then 1.5-3 additional turns. Shown completed in **Figure 14c**.
- g) Locate the supplied bypass valve (BPV) and OEM Mazda BPV gasket. Install the gasket into the groove in the bottom of the BPV. Groove shown with **red arrows** in **Figure 14d**.



**Figure 14c**



**Figure 14d**

- h) Install the BPV onto the cold side intercooler piping using the supplied M6 25mm bolts & M6 nuts. Ensure the outlet of the BPV faces the NPT plug as shown in **Figure 14e**.



**Figure 14e**

**DETAILED INSTRUCTIONS:****14. Cold Side Intercooler Piping Installation (continued)**

- i) Insert the cold side intercooler pipe into the engine bay and slide the straight end into the cold side intercooler silicone installed earlier. Then slide the curved end into the throttle body silicone installed earlier. Shown loosely in position in **Figure 14f**.

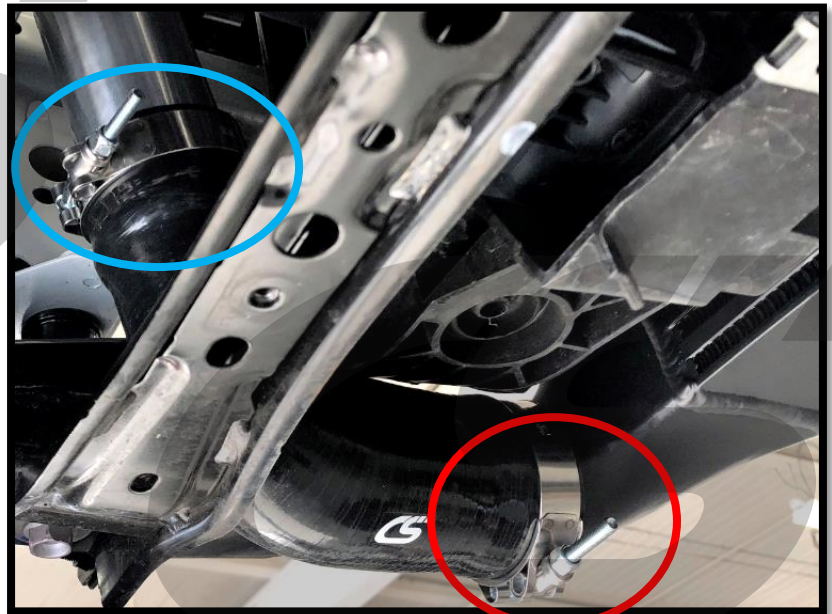
**Figure 14f**

- j) Rotate & shift the cold side silicone as needed until it has the best clearance possible to the radiator core support and subframe. It is OK if the silicone touches the subframe or radiator core support slightly, but, no sharp edges can touch the silicone or it could be damaged.

- k) Once happy with fitment, secure the cold side silicone to the intercooler with a 70-78mm clamp. Use the method from Step 13j, where the nut is removed and the clamp is fed between the intercooler and radiator core support. Clamp orientation shown with **red circle** in **Figure 14g**. Tighten the clamp with a 10mm deep socket. On all clamps, the silicone will bulge slightly around the edges of the clamp when tight.

- l) Secure the upper portion of the cold side silicone to the cold side intercooler piping with a 70-78mm clamp. Shown with **blue circle** in **Figure 14g**.

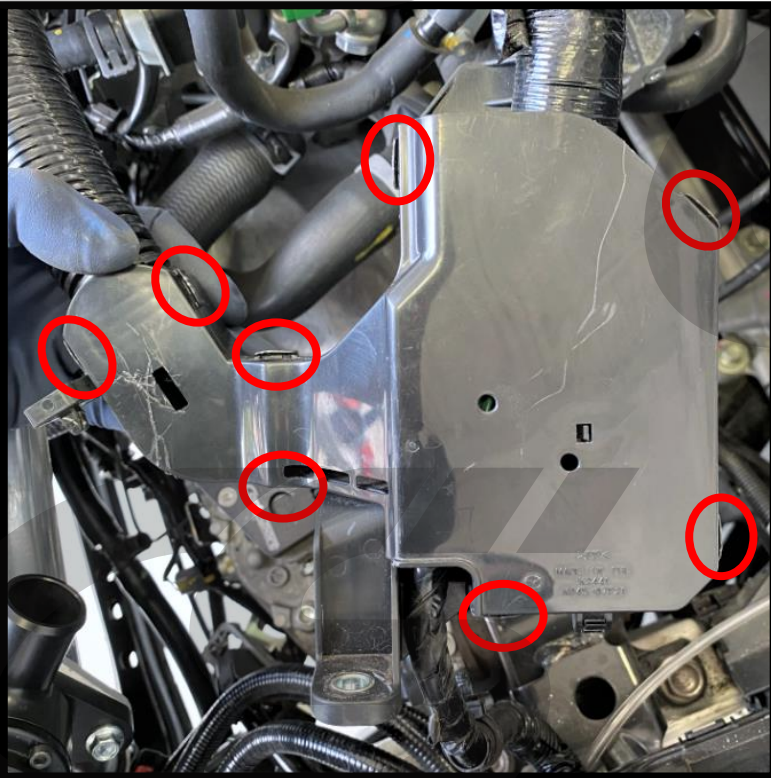
- m) Finally, tighten the 70-78mm clamp securing the cold side pipe to the throttle body silicone.

**Figure 14g**

## **DETAILED INSTRUCTIONS:**

### **15. Wiring Harness Cleanup & ECU Relocation**

- a) Locate the ECU harness that was unplugged earlier. We will be removing the large black plastic cover shown in **Figure 15a**.
- b) There are eight tabs that need to be released in order for the two halves of the plastic cover to separate. Locations shown **circled in red** in **Figure 15a**, and a close-up of a tab is shown in **Figure 15b**. Use a flathead screwdriver to pry each clip free. Once the clips are free, one half of the cover can be removed.



**Figure 15a**



**Figure 15b**

- c) Remove the two gray wiring clips securing the harness in the black cover using needle nose pliers. Locations are shown **circled in red** in **Figure 15c**. Once removed, the other half of the wiring harness cover can be removed.

- d) Then remove the gray clips from the wiring harness. They work like a zip-tie and can be released without cutting.



**Figure 15c**

## DETAILED INSTRUCTIONS:

### 15. Wiring Harness Cleanup & ECU Relocation (continued)

- e) You will be left with the harness which includes some bare wiring and some dead end connections. Shown in **Figure 15d** for reference. We will mount the ECU then come back to cover this wiring.
- f) Remove the ECU from the OEM ECU bracket by removing the two 10mm nuts and one 10mm bolt shown **circled in red** in **Figure 15e**.

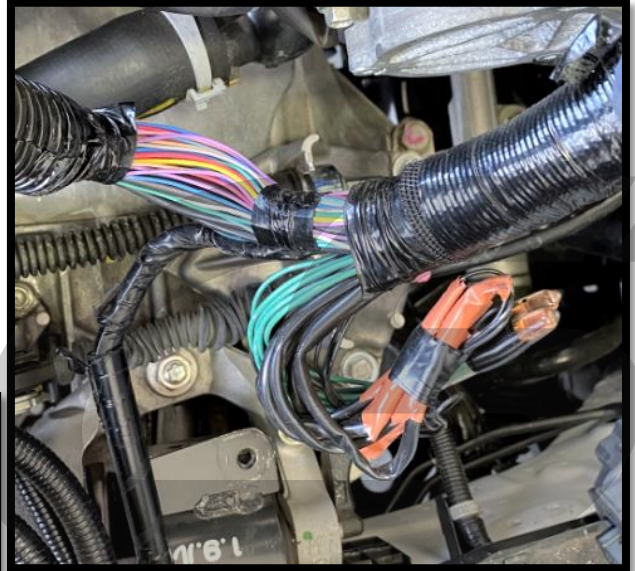


Figure 15d

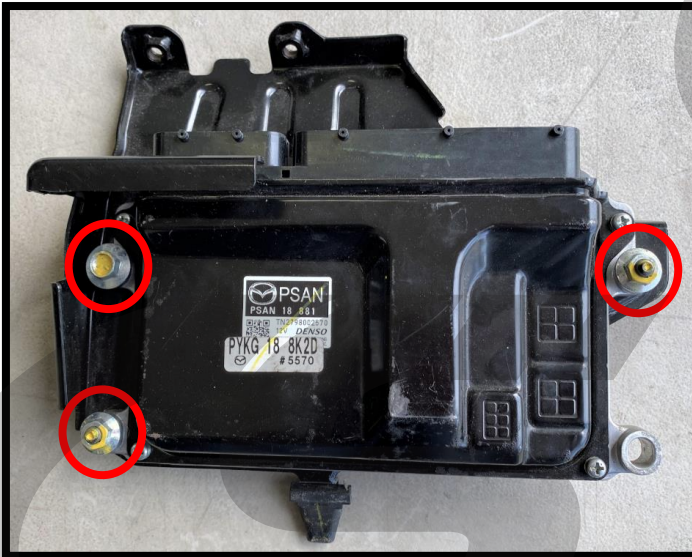


Figure 15e

- g) Mount the ECU to the supplied CS bracket using the supplied M6 20mm bolts & M6 nuts. Ensure it is in the orientation shown or fitment issues may occur. Shown installed on the bracket in **Figure 15f**.

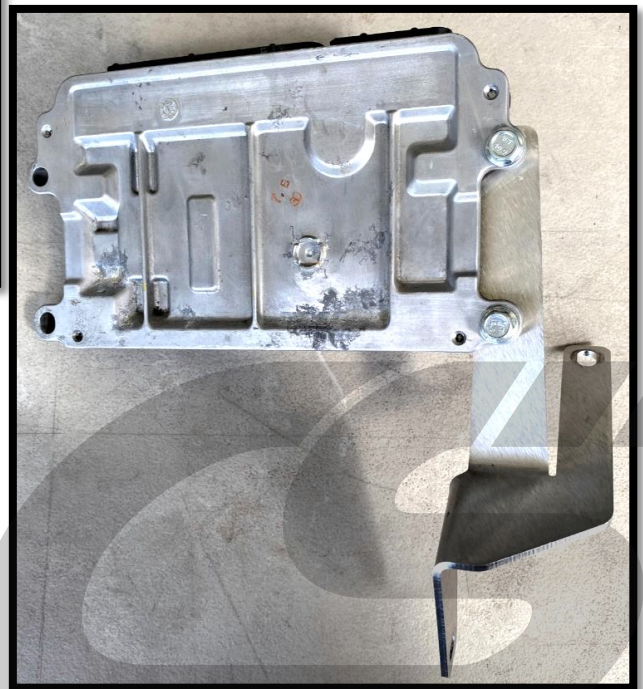
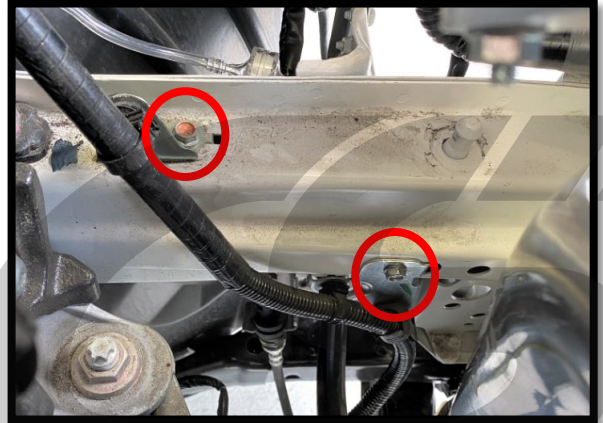


Figure 15f

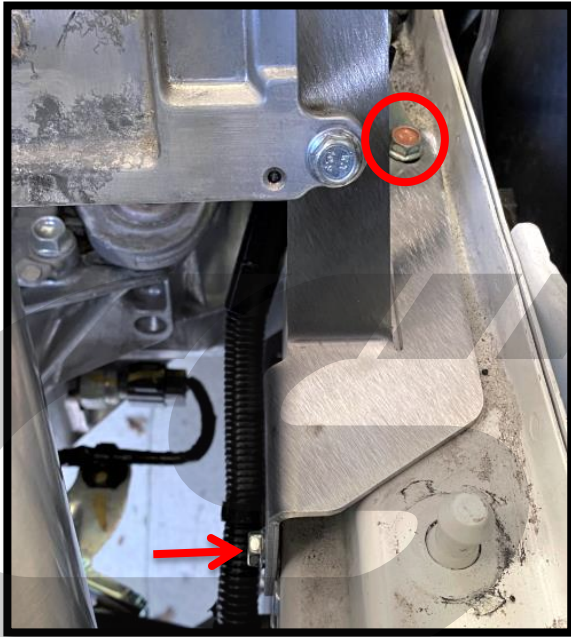
## DETAILED INSTRUCTIONS:

### 15. Wiring Harness Cleanup & ECU Relocation (continued)

- h) Locate and remove the two bolts from the driver's side frame rail using a 10mm socket and ratchet. They are circled in red in **Figure 15g**
- i) Mount the CS ECU bracket with ECU attached to these bolt locations. Secure using the upper location with supplied M6 20mm long bolt. The lower location can use the OEM hardware. Shown completed in **Figure 15h**.

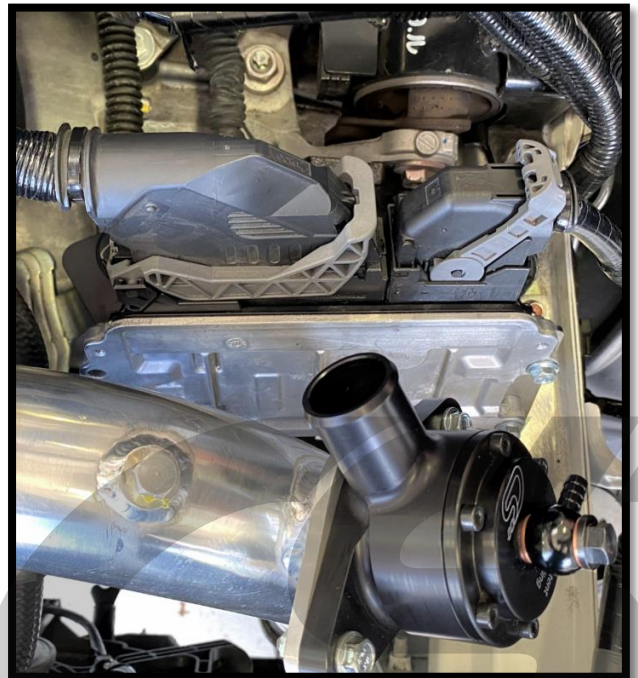


**Figure 15g**



**Figure 15h**

- j) Once the ECU is mounted, check all around it for clearance to the shifter linkage and all other components. If needed, the ECU bracket can be bent slightly for clearance.
- k) Next, plug in the ECU connectors. They will fit in with almost no effort. They are secured by rotating the gray clips downward. Shown completed in **Figure 15i**.

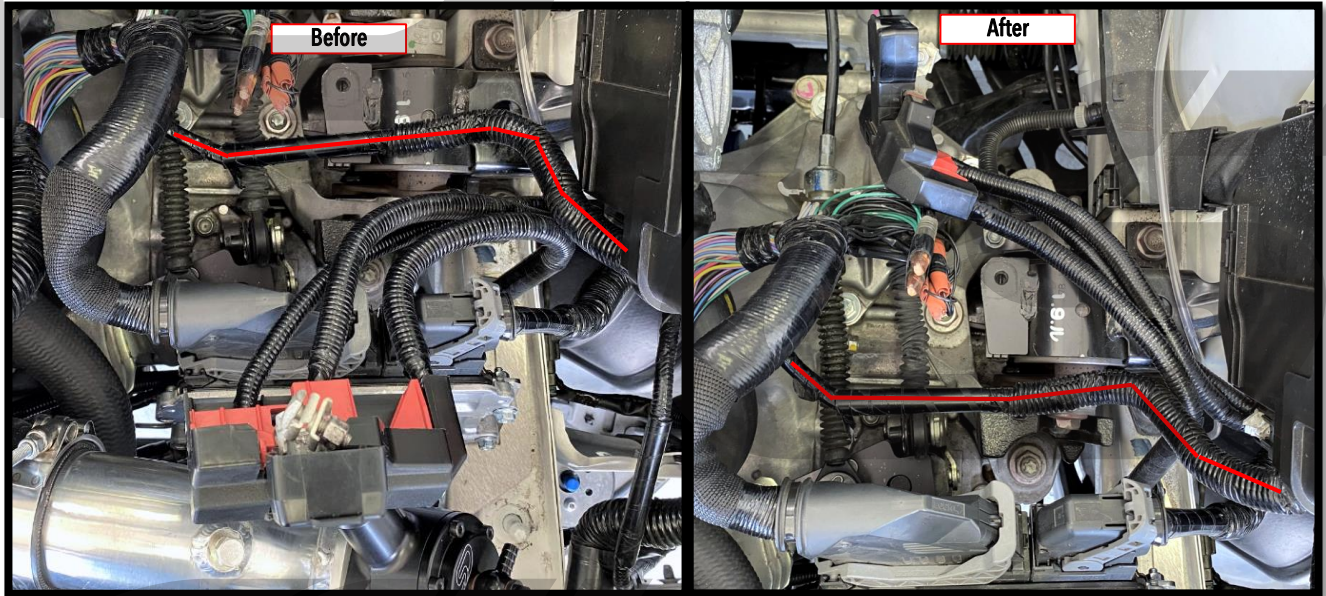


**Figure 15i**

## DETAILED INSTRUCTIONS:

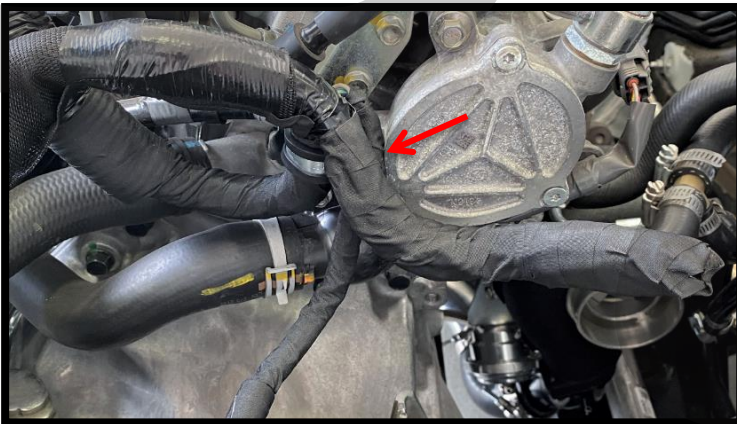
### 15. Wiring Harness Cleanup & ECU Relocation (continued)

- l) Route the positive battery terminal underneath the wiring harness shown with **red lines** in **Figure 15j**. This allows the positive terminal to more easily reach the new battery location. The change in positioning is shown in **Figure 15j**.



**Figure 15j**

- m) Position your harness near the engine where it will be out of the way from the battery and tray that will be installed later. Match the approximate location shown in **Figure 15k**.
- n) Wrap all exposed wires with electrical tape to protect them. We strongly recommend "Tesa" Tape instead of regular electrical tape. Shown in **Figure 15l**. Tesa tape is easier to use, looks nicer, and does not leave as much of a sticky residue as regular tape.



**Figure 15k**



**Figure 15l**



## DETAILED INSTRUCTIONS:

### 15. Wiring Harness Cleanup & ECU Relocation (continued)

- o) Secure the wiring harness to the engine with the supplied 3/4" loop clamp. Use the OEM vacuum pump mounting location marked with red arrow in Figure 15k on the previous page. Loop clamp shown in position in Figure 15m.
- p) Once harness is secured, double check around it to ensure it will not rub on anything sharp or get caught in any moving parts.



Figure 15m

### 16. Miscellaneous Plumbing Installation

- a) Locate the compressor inlet silicone. It is a large straight silicone with a ~1.5" diameter "offshoot".
- b) Install the compressor inlet silicone onto the turbocharger with an 86-94mm clamp loosely pre-installed. Ensure the orientation of the "offshoot" approximately matches Figure 16a.

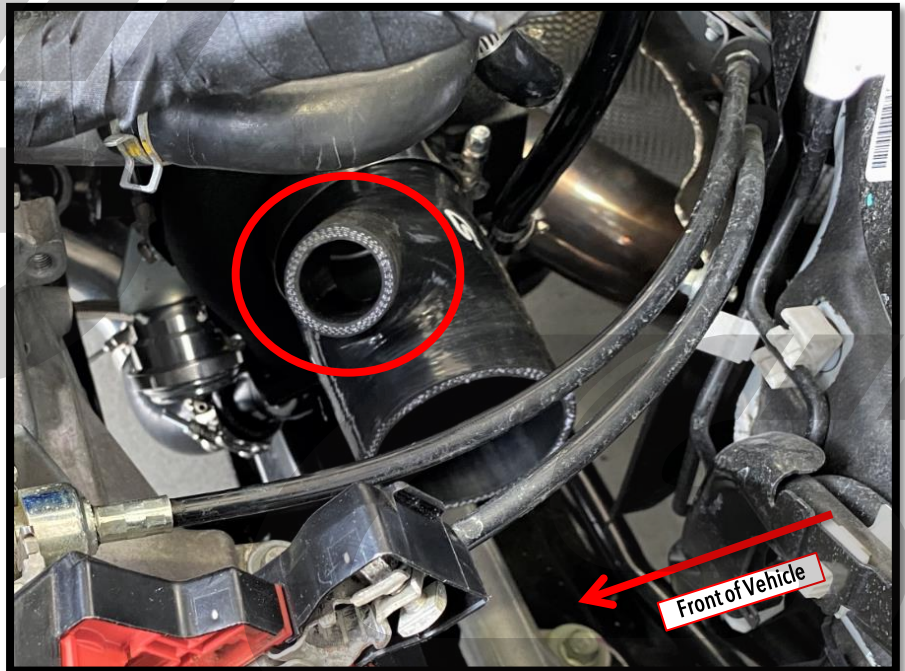
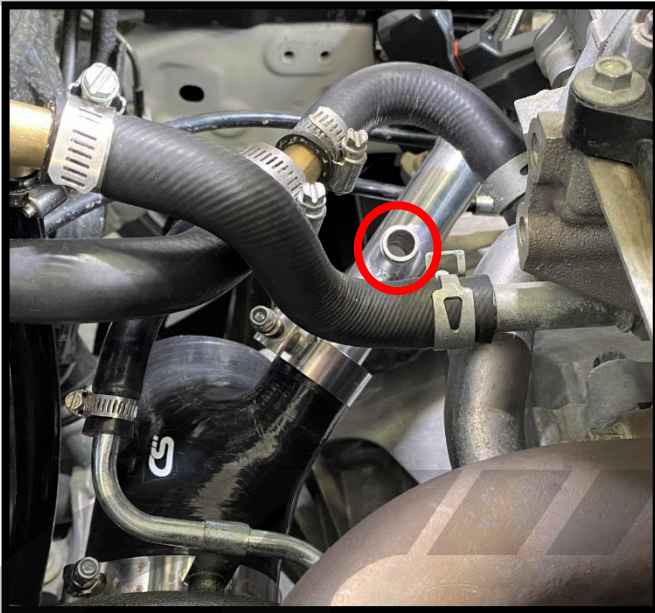
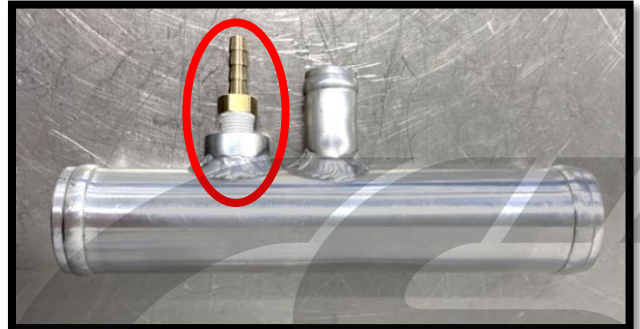


Figure 16a

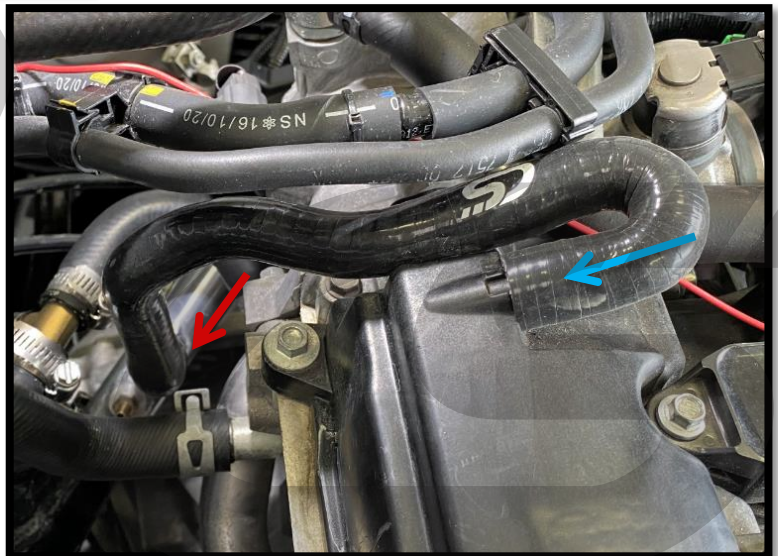
**DETAILED INSTRUCTIONS:****16. Miscellaneous Plumbing Installation (continued)**

- c) **Locate the brass barb fitting supplied in you kit.** Apply PTFE thread tape or sealant to the NPT threads of the fitting and install it into the open port on the BPV recirculation pipe. Tighten hand tight, then 1.5-3 additional turns. Shown completed in **Figure 16b**.

**Figure 16c****Figure 16b**

- d) **Install the BPV recirc pipe into the offshoot of the compressor inlet silicone.** Install with a 38-43mm clamp pre-installed loosely onto the offshoot of the silicone. The end closer to the brass barb should be inserted into the compressor inlet silicone. Approximate orientation shown in **Figure 16c**, where the open barbs face the gap in the heater core hoses.
- e) **Locate the valve cover breather hose.** It is a small silicone hose with a sharp 180° turn on one end.

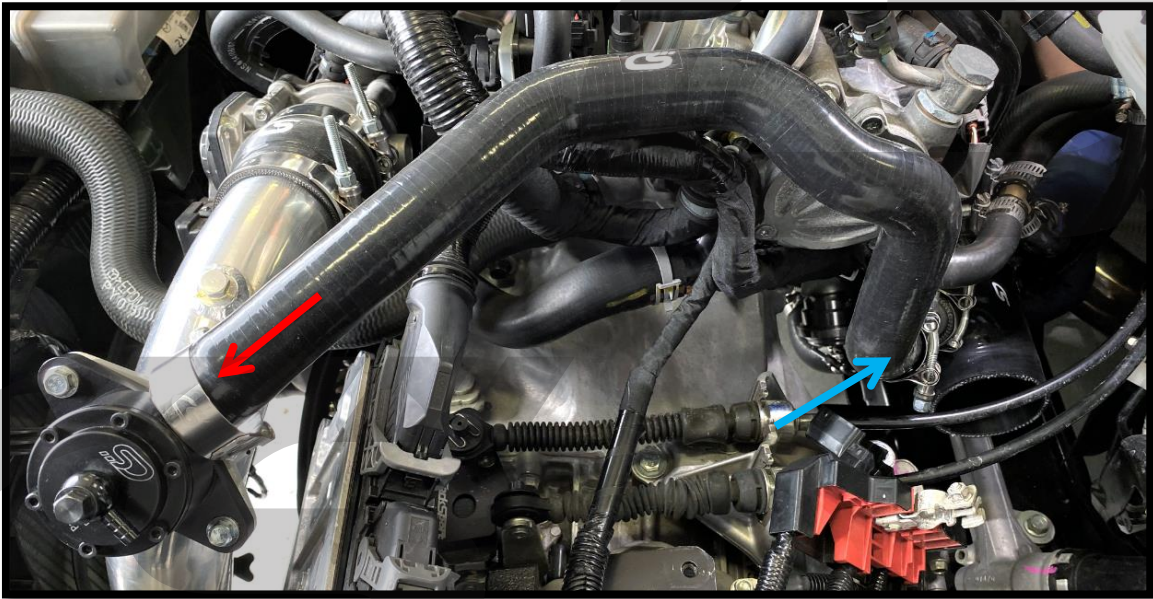
- f) **Install the straight end of the valve cover breather hose onto the open port circled in red in Figure 16c.** Shown completed and with **red arrow** in **Figure 16d**.
- g) **Install the end with 180° turn onto the open port on the valve cover.** The OEM intake breather was removed from this port back in Step 3f. Shown completed & with **blue arrow** in **Figure 16d**.
- h) **Rotate the compressor inlet silicone and/or the BPV recirc pipe as needed for best fitment.**

**Figure 16d**

## **DETAILED INSTRUCTIONS:**

### **16. Miscellaneous Plumbing Installation (continued)**

- i) **Locate the BPV silicone.** It is a long ~1.5" diameter silicone hose with many bends.
- j) **Install the BPV silicone as shown in Figure 16e.** One end connects to the bypass valve itself as shown with a **red arrow** in **Figure 16e**. The other end connects to the BPV recirc pipe as shown with a **blue arrow** in **Figure 16e**. Loosely install a 38-43mm clamp on each end of the BPV silicone.



**Figure 16e**

- k) **Rotate the compressor inlet silicone and/or the BPV recirc pipe as needed for best fitment** of the BPV hose and the valve cover breather hose.
- l) **Once happy with fitment, tighten the 86-94mm clamp at the turbo and the three 38-43mm clamps.** When tight, the silicone will bulge slightly at the ends of the clamp.

**DETAILED INSTRUCTIONS:**

---

**16. Miscellaneous Plumbing Installation (continued)**

We strongly recommend installing an oil catch can (OCC) kit with the CS turbo kit. The kit can be ran without an OCC but for long term engine health, a catch can is recommended. If installing a catch can, please do so at this time, it will replace the valve cover breather hose installed earlier. Check out the CorkSport OCC for Turbo Kit that has the correct setup with the turbo kit at the link/QR Code below:

<https://corksport.com/2014-2018-mazda-3-and-2013-2017-mazda-6-turbo-oil-catch-can-kit.html>



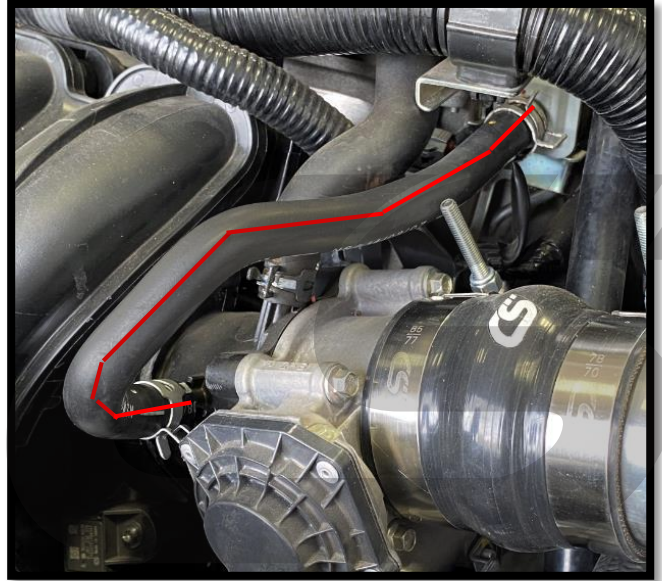
If you already have an existing CorkSport or similar oil catch can installed on your Mazda, **the naturally aspirated setup will not work correctly with the turbo kit.** To get the rest of the parts you need for correct function, there is a separate "upgrade to boosted" kit available at the above link.

Failure to change to correct routing for a turbocharged application will pressurize your oil catch can system, causing poor PCV system function, potential for burning oil, and long term engine health risk.

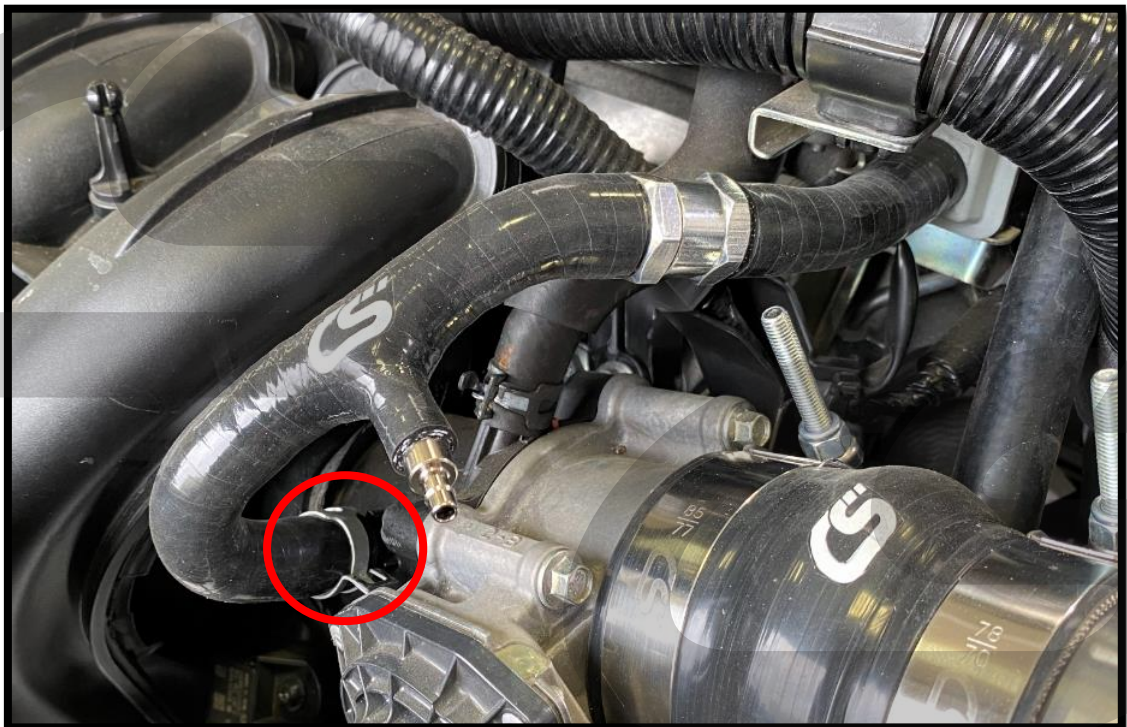
## **DETAILED INSTRUCTIONS:**

### **16. Miscellaneous Plumbing Installation (continued)**

- m) Remove the OEM hose located near the throttle body and shown with red lines in **Figure 16f**. Use needle nose pliers to slide the clamps out of the way, then the hose can be pulled free from the vehicle. One of the OEM clamps will be re-used.
  
- n) Locate the CS boost reference hose. It is a small silicone hose with a check valve & barb pre-installed in the hose.
  
- o) Install the CS boost reference hose in place of the OEM hose removed earlier. Use an OEM clamp in the location **circled in red** in **Figure 16g**. Hose shown fully installed in **Figure 16g**. This hose clamp will be a snug fit.



**Figure 16f**



**Figure 16g**

## DETAILED INSTRUCTIONS:

### 16. Miscellaneous Plumbing Installation (continued)

- p) Route some supplied 4mm silicone hose from the boost source we just installed to the frame rail on the driver's side. See the **red lines** in **Figure 16h**. Routing this silicone forward and underneath the radiator cowl to hide it helps give a clean look. Ensure this hose can not get kinked or cut.
- q) Locate the supplied plastic tee fitting in the boost gauge kit and connect it to the end of this hose. Approximate location **circled in blue** in **Figure 16h**.
- r) Connect the center of the tee fitting to the fitting on top of the bypass valve using some more 4mm silicone hose. See the **green lines** in **Figure 16h**.
- s) Once happy with alignment, tighten the top fitting of the bypass valve with a 10mm wrench to ~7ft-lbs.
- t) Connect a small 3-4" extension of 4mm silicone hose off the remaining port of the tee fitting to be used later.

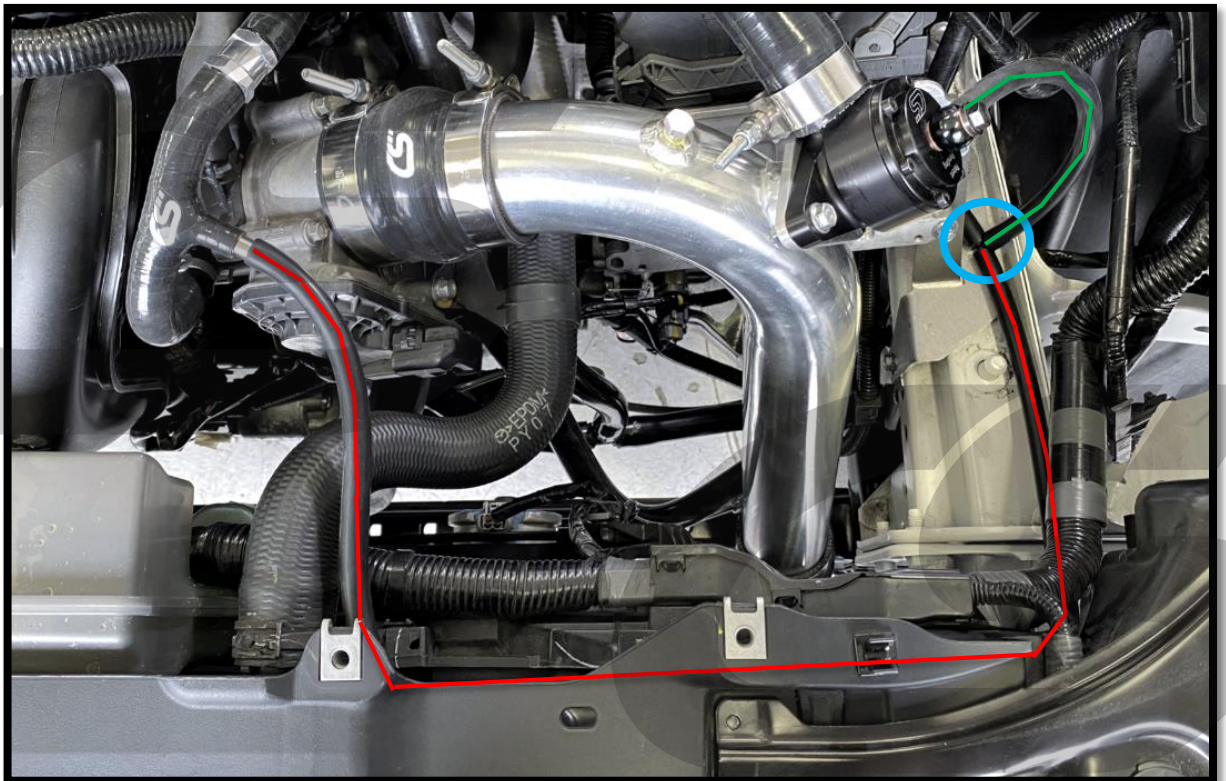


Figure 16h

## DETAILED INSTRUCTIONS:

### 17. Routing Components Through the Firewall



We skip ahead to some minor wiring at this stage as the firewall is still easy to access. Wiring will be completed in later sections.

- a) Locate the large rubber wiring grommet on the driver's side of the firewall. It is shown circled in red in Figure 17a.
- b) On this grommet, there is a small "bulb" sticking out next to the main harness. Cut off the end of this bulb with scissors or a razorblade. Shown cut with wires already through it in Figure 17b. Cutting off the end of this "bulb" opens an easy path through the firewall that is safe from weather and will not damage the wiring/hose. NOTE: some vehicles have a smaller bulb that may require an additional hole to be drilled/cut in the rubber grommet.



Figure 17a

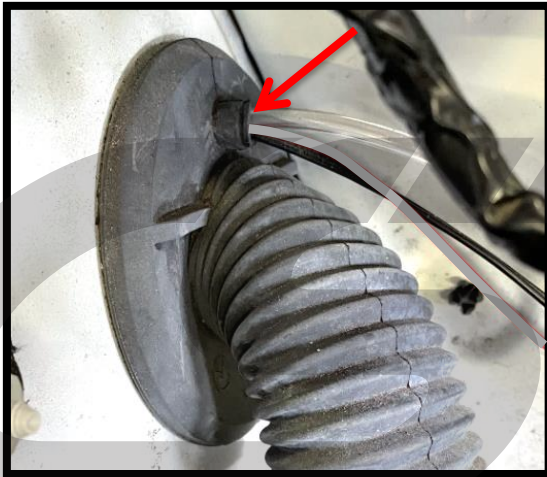


Figure 17b

- c) Open your packaged boost gauge and locate the filter and clear boost reference hose.
- d) Connect the filter to the short extension hose coming off the boost reference tee that was setup in Step 16s. Shown completed in Figure 17c.



Figure 17c

## DETAILED INSTRUCTIONS:

### 17. Routing Components Through the Firewall (continued)

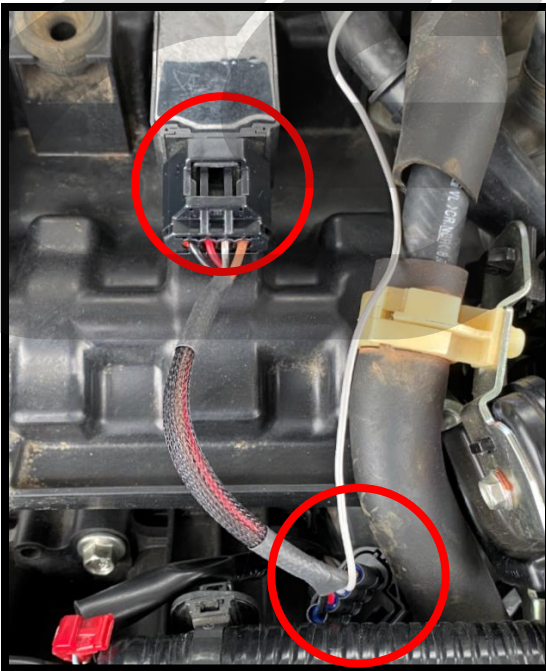
- e) Connect the clear hose to the filter and route the hose along the frame rail and through the hole in the firewall grommet prepared earlier. You may need to cut/drill an additional hole in the grommet if the one in the "bulb" is too small. Leave the hose long, it can be trimmed from inside the car later. **Ensure this hose can not get kinked or cut.**
- f) Locate the supplied ignition jumper harness. It is the ~5" long wiring harness with two connectors and a long gray wire that comes off of it, shown in **Figure 17d**.
- g) Unplug one of the OEM coil packs and plug the ignition jumper harness in between. Which coil it is does not matter. This is shown completed in **Figure 17e** with each end of the ignition jumper harness **circled in red**.
- h) Route the long gray wire along the hoses on top of the engine and then thru the firewall grommet prepared earlier. Approximate routing shown with **curved red line** in **Figure 17f**. Leave the wire long, we will trim it later.



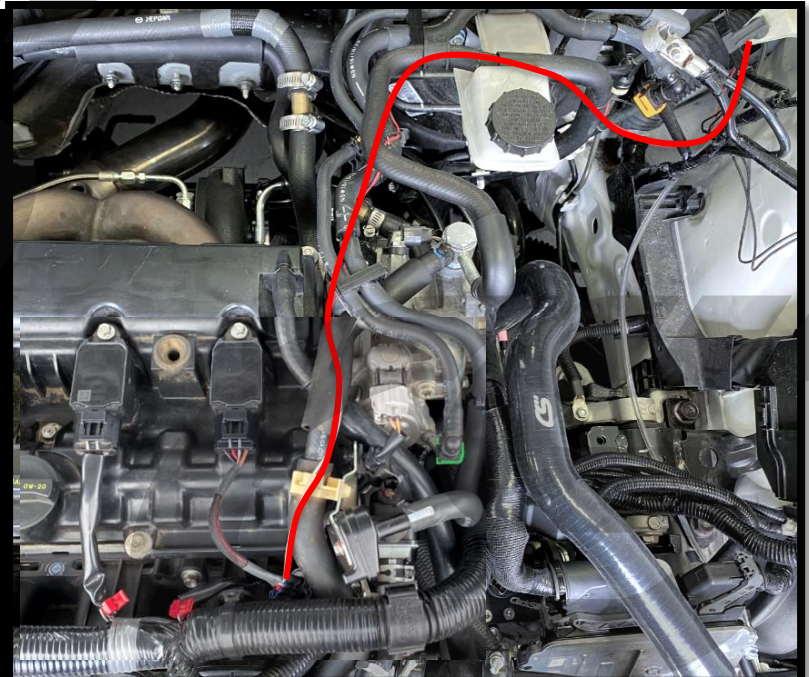
**Figure 17d**



The long gray wire can be hidden from view and routed under the hoses and lines. Use zip ties to secure it away from any moving parts or sources of heat.



**Figure 17e**



**Figure 17f**



## DETAILED INSTRUCTIONS:

### 17. Routing Components Through the Firewall (continued)

- i) Open your Turbosmart boost controller and locate the black wiring. It is two black wires adhered together.
- j) Route these wires through the firewall grommet prepared earlier
- k) Route the other end to the approximate location circled in blue in Figure 17g. The wiring can follow the gray wire routed in Step 17h.

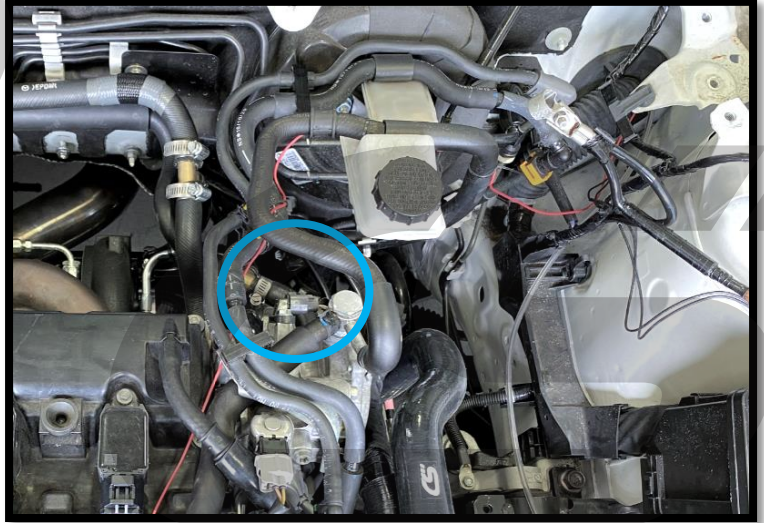


Figure 17g

### 18. Negative Terminal Harness Modification

NOTE

If following our installation video, this section is not included in the video. At time of filming, the vehicle already had this portion of the installation completed.

- a) Locate the negative battery terminal. It has a main ground on the strut tower and then runs downward and towards the firewall. Shown in Figure 18a.
- b) This harness will need to be modified slightly to give enough flexibility for the new battery location.
- c) Remove the white clip from the harness and from the stud on the strut tower. This clip can then be disposed of. Clip circled in red in Figure 18a.

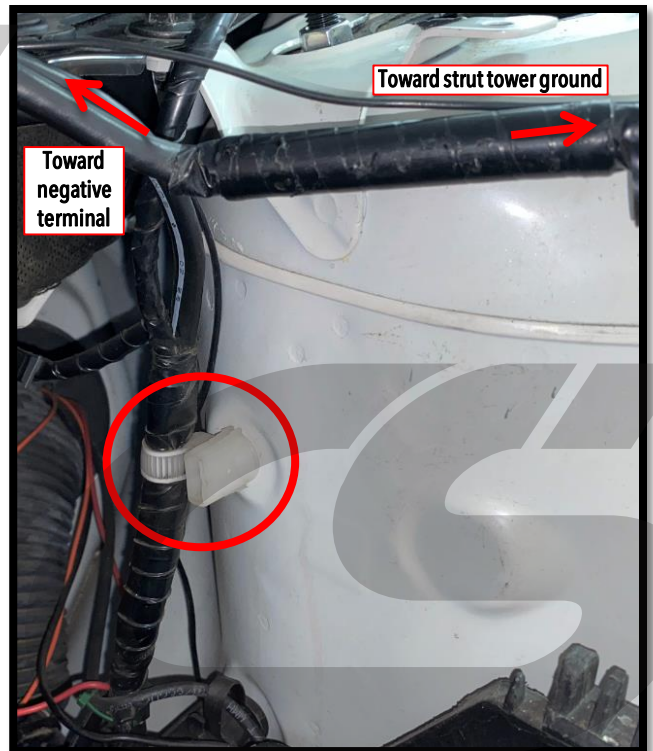


Figure 18a

## DETAILED INSTRUCTIONS:

### 18. Negative Terminal Harness Modification (continued)

- d) Trim the wiring harness tape downward, until the negative terminal wiring can be separated from the rest of the harness. Shown completed in **Figure 18b**. Distance needed to trim shown with **red lines**.
- e) Separate the negative terminal wiring as shown in **Figure 18b**, then re-wrap any exposed wires with electrical tape. Shown completed in **Figure 18b**.
- f) Finally, unbolt the main ground from the strut tower, and flip it over. This gains just a bit of extra flexibility. Re-secure with a 10mm socket and ratchet. Tighten until snug. Shown with **blue circle** in **Figure 18b**.

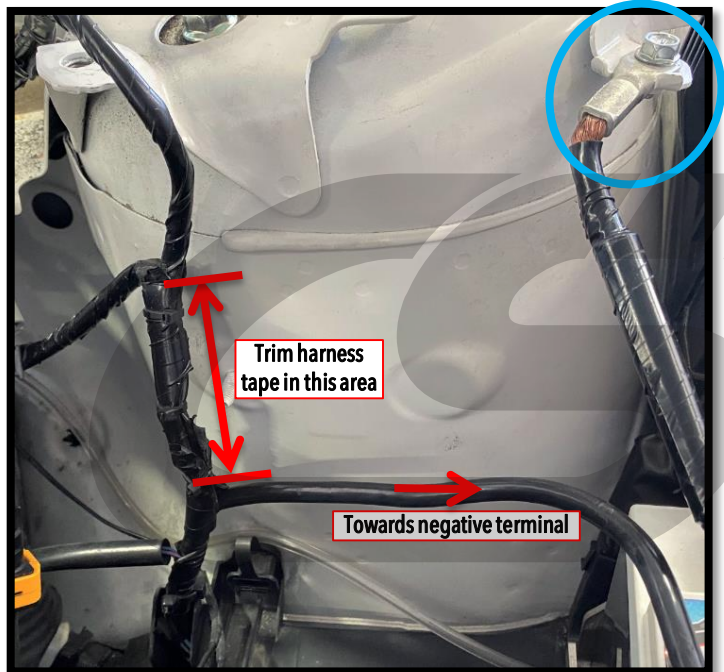


Figure 18b

### 19. Intake Assembly & Installation

**NOTE** If following our installation video, this section deviates from the video slightly as we have since determined a slightly easier method than shown in the video. However, either option works well for install.

- a) **Locate the CS intake tube.** It is the ~3" diameter tube with a ~70° bend and expanded ends. Shown in **Figure 19a**.
- b) **The intake tube has a "long" end and a "short" end.** The distance refers to the length of straight section at the end of the pipe before the bend. Long & short sections labeled in **Figure 19a**.

**NOTE** The long end vs. short end is most easily seen when the pipe is in the orientation show in **Figure 19a**.

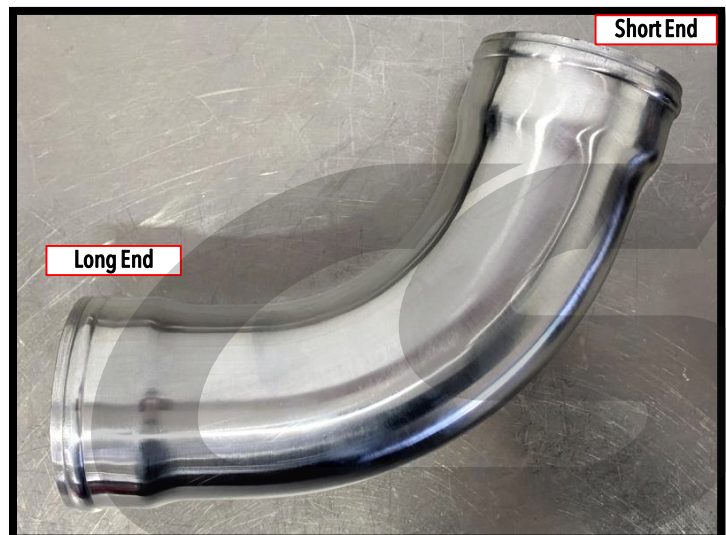


Figure 19a

## DETAILED INSTRUCTIONS:

### 19. Intake Assembly & Installation (continued)

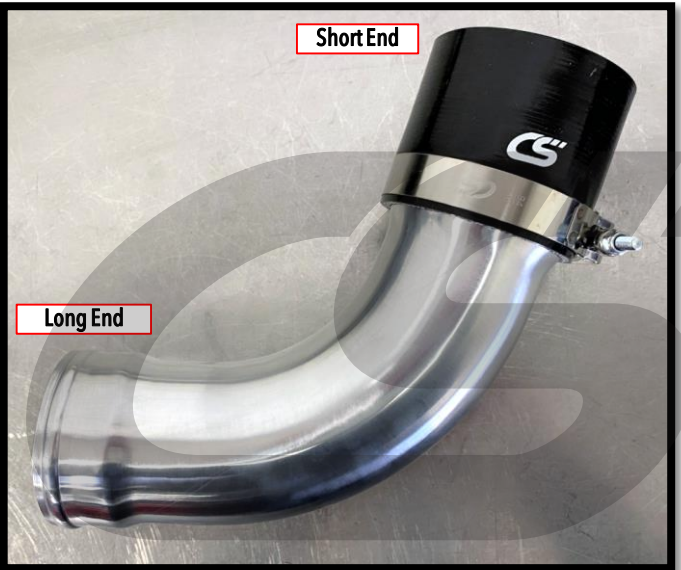
- c) Locate the MAF silicone and install it onto the "short" end of the intake tube. The MAF silicone is a straight ~3" piece of silicone. Secure with a 86-94mm clamp. Shown completed in **Figure 19b**.

**NOTE**

We recommend following the clamp orientations shown as they allow access once the assembled intake is installed on the vehicle..

- d) Locate the MAF sensor located on the OEM airbox. Remove the MAF sensor by removing the two screws with a Phillips head screwdriver. Shown **circled in red** in **Figure 19c**.

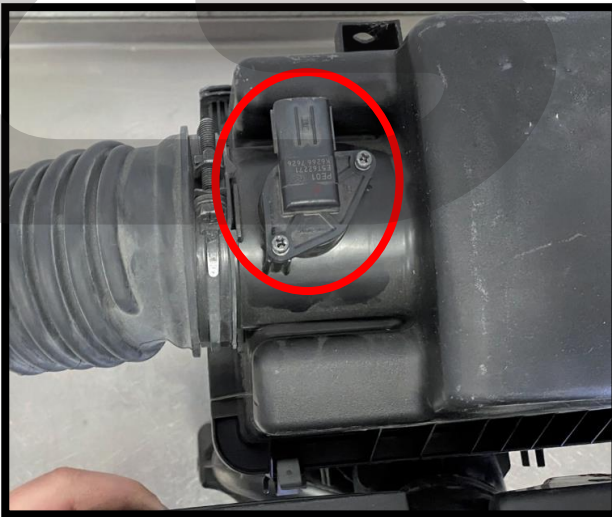
- e) Swap the OEM MAF sensor onto the CS MAF housing. Secure it with the two Allen head screws supplied with the MAF housing. Tighten the screws until snug using a 3mm Allen Wrench. Shown completed in **Figure 19d**.



**Figure 19b**

**NOTE**

Ensure the MAF sensor o-ring is not pinched or damaged during installation.



**Figure 19c**



**Figure 19d**

## DETAILED INSTRUCTIONS:

### 19. Intake Assembly & Installation (continued)

- f) Install the MAF housing into the MAF silicone. Follow the MAF housing alignment shown in **Figure 19e**. Secure with an 86-94mm clamp in the orientation shown. Shown completed in **Figure 19f**.
  
- g) Install the supplied air filter onto the end of the MAF housing. Secure with a 95-103mm clamp in the orientation shown in **Figure 19f**.



Figure 19e



Figure 19f

- h) Install the CS rear battery tray mounting bracket using OEM hardware and the OEM bracket mounting location. Tighten the three 12mm bolts to **15-20ft.-lbs.** Bolts shown with **red arrows** in **Figure 19g**. This step is performed here as it is easier to install this bracket before the intake is in position.

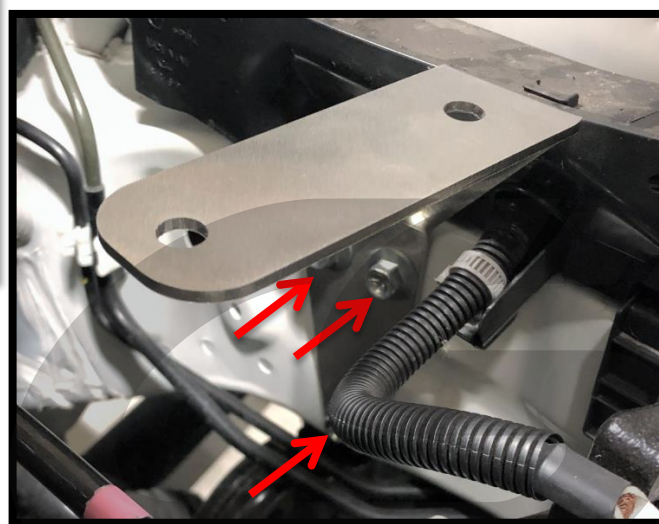
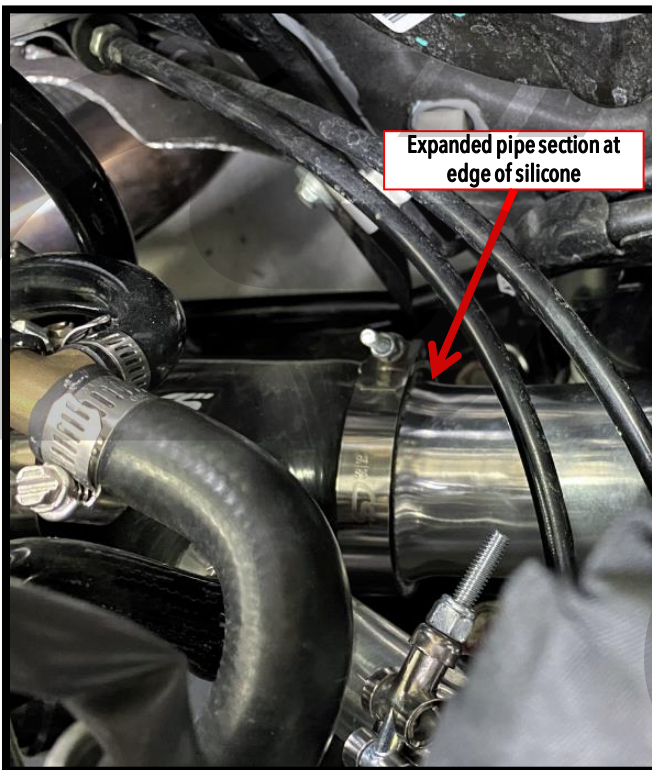


Figure 19g

## **DETAILED INSTRUCTIONS:**

### **19. Intake Assembly & Installation (continued)**

- i) Place a 86-94mm clamp onto the open end of the compressor inlet silicone.
- j) Then insert the assembled intake tube into the compressor inlet silicone. Only insert the tube as far as the expanded section of pipe. Any deeper and you will not get a secure seal with the clamp. Shown installed in **Figure 19h**.
- k) Rotate the intake tube until the intake tube and filter are not touching any components. It is a snug fit, and the filter will end up fairly close to the components near the firewall.
- l) Once happy with fitment, tighten the final 86-94mm clamp. Approximate final filter location shown in **Figure 19i**.



**Figure 19h**



**Figure 19i**

## DETAILED INSTRUCTIONS:

### 19. Intake Assembly & Installation (continued)

- m) Locate the supplied MAF sensor wiring harness extension. It is approximately 2ft. long and is shown in **Figure 19j**.

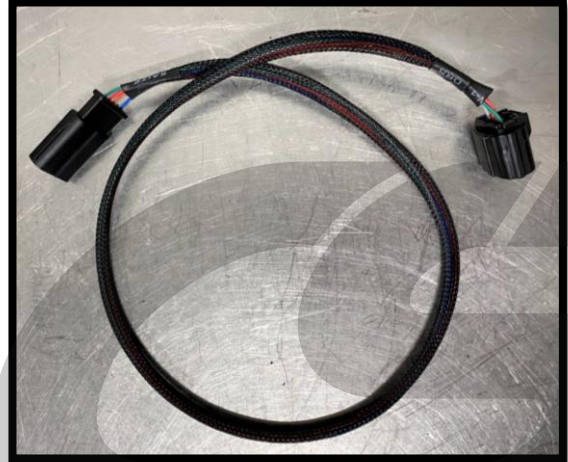


Figure 19j

- n) Connect one end of this harness to the MAF sensor near the air filter. Route the harness along the driver's side chassis rail and connect it to the original MAF sensor plug at the front of the vehicle. Tuck the excess harness length away and safe from any moving parts. Approximate routing shown with red arrows in **Figure 19k**.

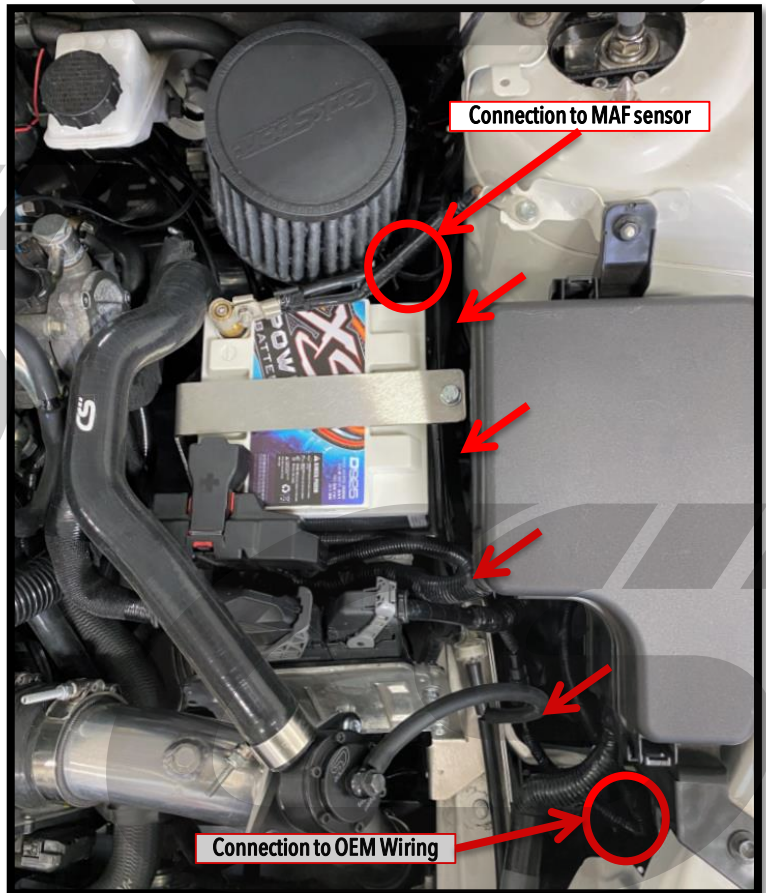


Figure 19k

- NOTE** **Figure 19k** shows the battery & battery tray already installed. This is done for added clarity in MAF wiring routing during installation of the battery tray in the next section.

## DETAILED INSTRUCTIONS:

### 20. Battery Tray & Battery Installation

- a) Remove the battery tie down bracket that comes pre-installed on your battery tray. Take note of how it is attached for a later step.
- b) Install the CS battery tray into the vehicle. It uses the OEM mounting location on the transmission mount and the two mounting locations provided with the CS battery tray bracket installed earlier. Use the OEM hardware for the center mount and the supplied M8 20mm bolts, M8 nuts, and washers to secure the rear mounts. Shown installed & mounting locations circled in red in Figure 20a. Tighten bolts to **15-20ft-lbs**.

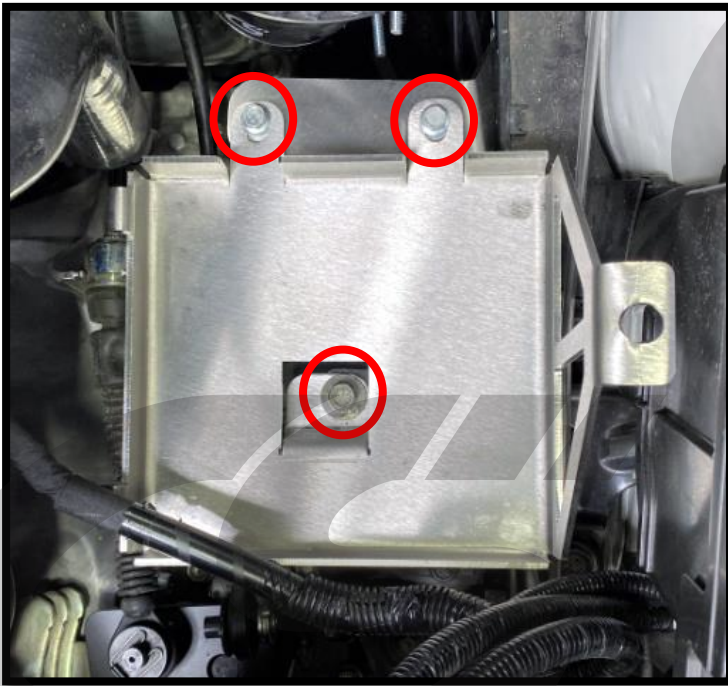


Figure 20a



Figure 20b

- c) Install the supplied battery into the battery tray. Match the orientation shown where the positive terminal is near the front of the vehicle. Shown installed in Figure 20b.
- d) Install the supplied terminals onto the battery. Use the supplied hardware and tighten until snug (**DO NOT EXCEED 8ft-lbs**) using a 5mm Allen wrench. The larger battery terminal attaches to the positive of the battery, shown circled in red in Figure 20b. The smaller battery terminal attaches to the negative of the battery, shown circled in blue in Figure 20b.



If you chose not to purchase a battery with your turbo kit or are a non-USA customer, please see the information on our website for proper battery sizing.

## **DETAILED INSTRUCTIONS:**

### **20. Battery Tray & Battery Installation (continued)**

- e) **Test fit the positive terminal of the wiring harness onto the positive terminal of the battery.** It should fit easily without rubbing on any components as shown in **Figure 20c**.
- f) **Remove the positive terminal once happy with your test fit.**
- g) **Test fit the negative terminal of the wiring harness onto the negative terminal of the battery.** Final fitment shown in **Figure 20d**. It is OK if the negative wiring is close to the air filter, but it is preferable if the wiring is not directly touching the filter. Adjust the intake tube if necessary to gain extra clearance. Some vehicles will have a much larger negative battery terminal than shown. You will need to clock this terminal to ensure good clearance to the filter and BPV hose installed earlier.
- h) **Remove the negative terminal once happy with your test fit.**



**Figure 20c**



**Figure 20d**



## DETAILED INSTRUCTIONS:

### 20. Battery Tray & Battery Installation (continued)

- i) Reinstall the battery tie down bracket that was removed from the battery tray earlier. One side hooks over two tabs, then the entire thing is secured with the remaining supplied M8 hardware through the hole in the other side. Tighten hardware until snug using a 13mm socket and wrench. Shown completed in **Figure 20e**.



We will leave the battery disconnected until all wiring is completed.



Figure 20e

### 21. EBCS Mounting & Line Routing

- a) Locate the Electronic Boost Control Solenoid (EBCS) in your Turbosmart boost controller kit. It is the black and blue box with three ports and two wires coming off of it. Shown in **Figure 21a**.
- b) Install the three supplied metal barb fittings into the ports on the EBCS. Wrap each fitting with PTFE thread tape or sealant, then install them hand tight, plus 1.5-3 turns to fully secure. Shown completed in **Figure 21a**.



The Turbosmart kit comes with plastic EBCS fittings however these are not used.



Take note of the numbers that are stamped into the blue part of the EBCS. These will be referenced later.

- c) Install the bracket supplied by Turbosmart. Mount it to the EBCS as shown in **Figure 21a**. Tighten hardware until snug.

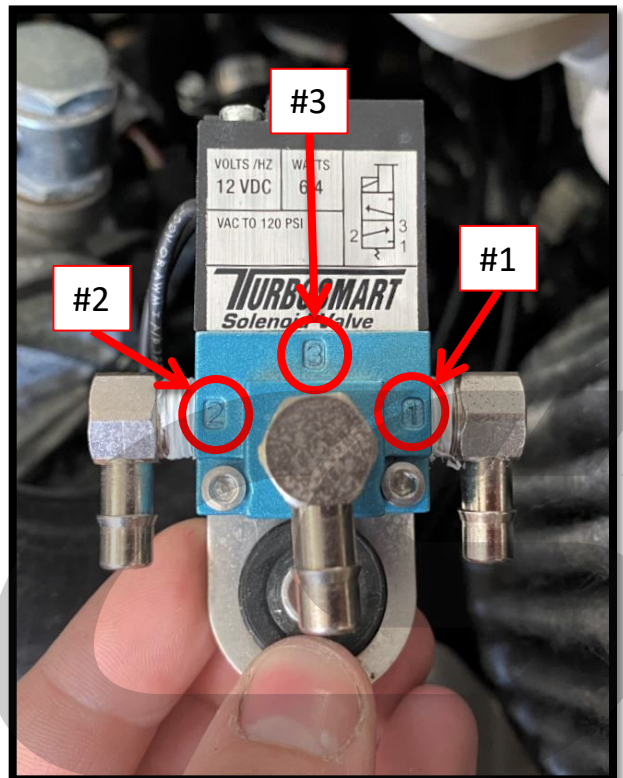


Figure 21a

## DETAILED INSTRUCTIONS:

### 21. EBCS Mounting & Line Routing (continued)

- d) Connect the two wires coming from the EBCS to the bonded **black wires** routed through the firewall back in Steps 17i-17k. The EBCS will end up mounted in the area these wires were ran to previously. Some notes when connecting these wires:
- Either of the bonded black wires can connect to either of the EBCS wires.
  - Using good quality "solder & seal" connectors like shown in **Figure 21b** makes for easy connections. We recommend using additional heatshrink over these connectors for extra strength & protection. Be sure to follow the instructions to ensure a good connection. **We recommend this style of connector for all future connections.**
  - If a different style of connector is used, ensure the connections are waterproof and can handle under hood engine heat

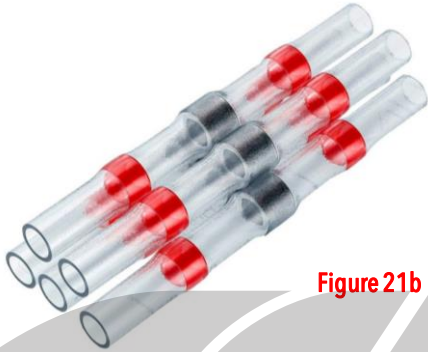


Figure 21b

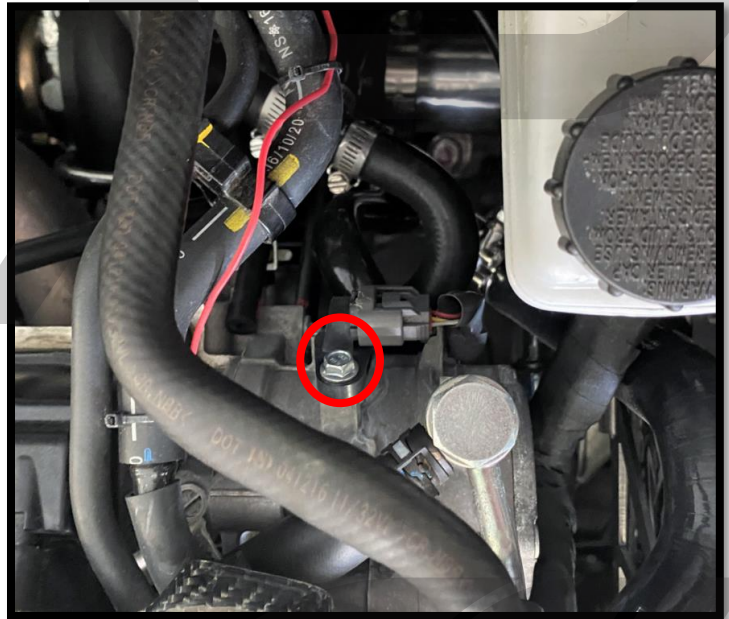


Figure 21c



The next few steps outline a possible mounting location for the EBCS. We like this location as it is easy to access to connect all the hoses and wiring however other locations can be used to mount the EBCS.

- e) Remove the bolt on the rear right side of the engine shown in **Figure 21c**. This bolt is in the location the black bonded wires were routed to earlier. The location is also **circled in blue** in **Figure 17g** on page 85.

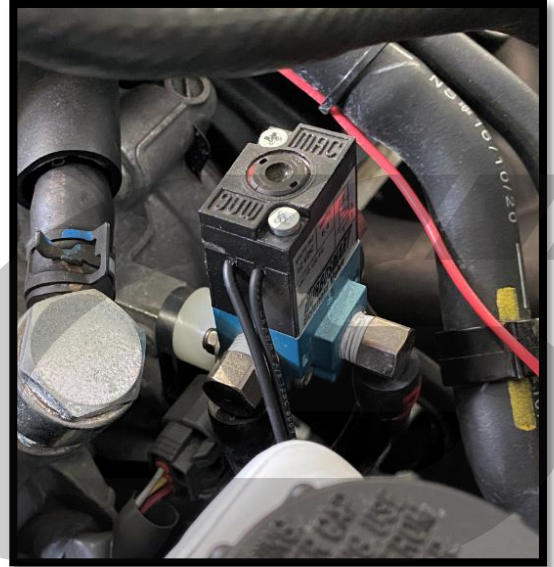
## DETAILED INSTRUCTIONS:

### 21. EBCS Mounting & Line Routing (continued)

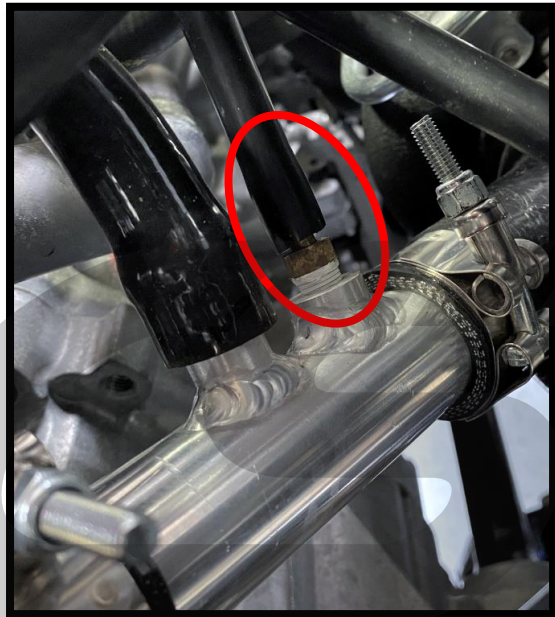
- f) Mount the EBCS where the bolt was removed in the previous step. Used the supplied nylon spacer and the supplied M6x1.0x35mm bolt. Shown completed in **Figure 21d**. Tighten the bolt until snug.

**NOTE** The included Turbosmart bracket may need to be bent slightly for best fitment on the vehicle.

**NOTE** The following steps connect the EBCS to the required boost reference locations. Route the silicone hoses away from any sharp edges or major sources of heat. Also ensure that they cannot be kinked.



**Figure 21d**



**Figure 21e**

- g) Using the supplied 4mm silicone hose, connect Port 1 of the EBCS to the brass barb installed into the BPV pipe recirc back in Step 16c. Brass barb shown in **Figure 21e**. Port 1 shown in **Figure 21a** on page 93.



**Figure 21f**

- h) Using the supplied 4mm silicone hose, connect Port 2 of the EBCS to the barb on the wastegate actuator. This is the shiny aluminum part attached to the turbocharger. Wastegate actuator shown in **Figure 21f**. Port 2 shown in **Figure 21a** on page 93.

## DETAILED INSTRUCTIONS:

### 21. EBCS Mounting & Line Routing (continued)

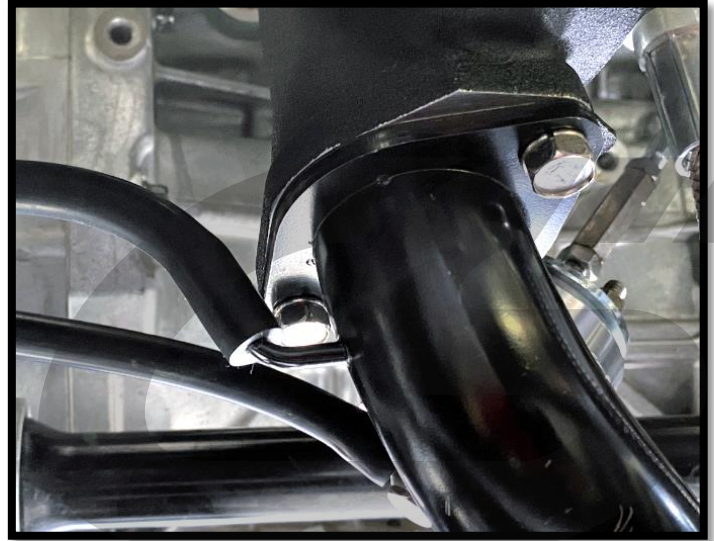
- i) Using the supplied 4mm silicone hose, connect Port 3 of the EBCS to the barb on the compressor outlet pipe. Compressor outlet pipe shown in **Figure 21g**. Port 3 shown in **Figure 21a** on page 93.



Failure to route the EBCS lines exactly as shown can result in overboosting and potential damage to your engine. Carefully double check all lines after initial setup.



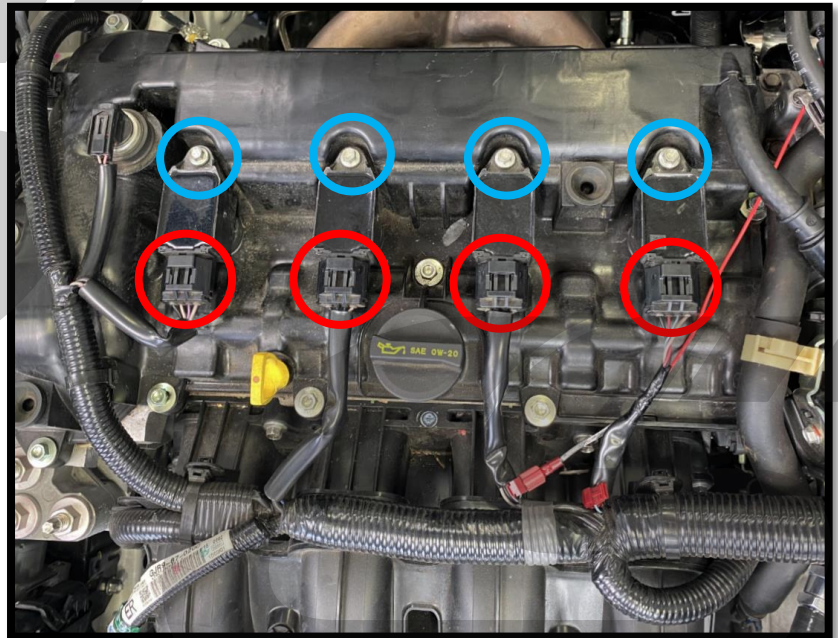
Ensure all EBCS lines are routed away from exhaust components and other sources of heat.



**Figure 21g**

### 22. Spark Plug Replacement

- a) Remove the coil plug from each coil pack. Shown circled in red in **Figure 22a**.
- b) Remove the coil pack mounting bolt from each coil pack. Use an 8mm socket and ratchet to remove. Shown circled in blue in **Figure 22a**.
- c) Then, remove each coil pack by pulling upwards. They should come free with little force.



**Figure 22a**

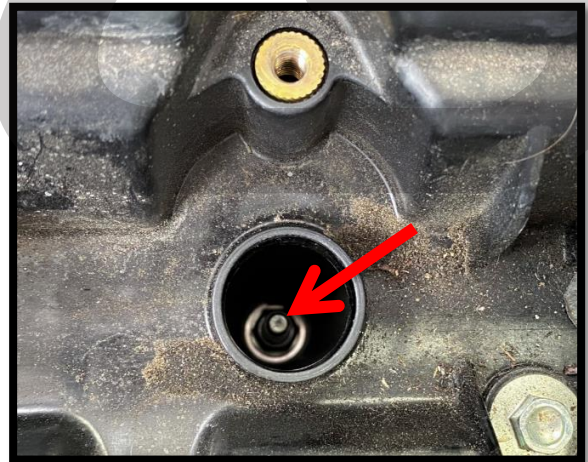
## DETAILED INSTRUCTIONS:

### 22. Spark Plug Replacement (continued)

- d) Remove the OEM spark plugs using a deep 14mm socket and extension. Remove them from the head using a magnet. Spark plug shown in **Figure 22b**.
- e) Gap each one of the supplied new spark plugs to 0.026". Check out the install video at the 1hr 23min mark for full details on how to properly gap your spark plugs.
- f) Use a magnet or spark plug socket to lower the new spark plugs into the engine. Dropping the plugs may damage them.
- g) Hand thread the plugs with a socket and extension to ensure they do not cross thread.
- h) Tighten each spark plug to **12-14ft-lbs.**
- i) Reinstall each coil pack and secure with the 8mm bolt removed earlier. Tighten until snug.
- j) Reconnect each coil pack to the wiring harness.



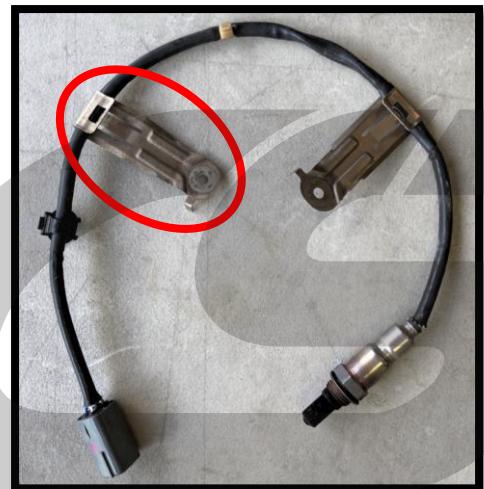
Spark plugs will need to be replaced every ~10,000 miles. Sometimes sooner depending on how hard the car is driven.



**Figure 22b**

### 23. O2 Sensor & Firewall Heatshield Reinstall

- a) Remove one of the wiring clips from the OEM O2 Sensor harness. Remove the one **circled in red** in **Figure 23a**.



**Figure 23a**

## DETAILED INSTRUCTIONS:

### 23. O2 Sensor & Firewall Heatshield Reinstall (continued)

- b) Install the O2 sensor into the CS downpipe. Use a small amount of anti-seize and tighten to **25-35ft-lbs** using an O2 sensor socket or 7/8" wrench. Shown completed in **Figure 23b**.
- c) Reinstall the OEM heater core hose support bracket using the OEM hardware. Nuts shown **circled in red** in **Figure 23b**.
- d) Reattach the OEM firewall heatshield to the OEM mounting points. Secure the O2 sensor to the closest mounting point using the OEM wiring clip. Tighten all bolts until snug. Mounting locations **circled in red** in **Figure 23c** with the wiring clip location **circled in blue**.

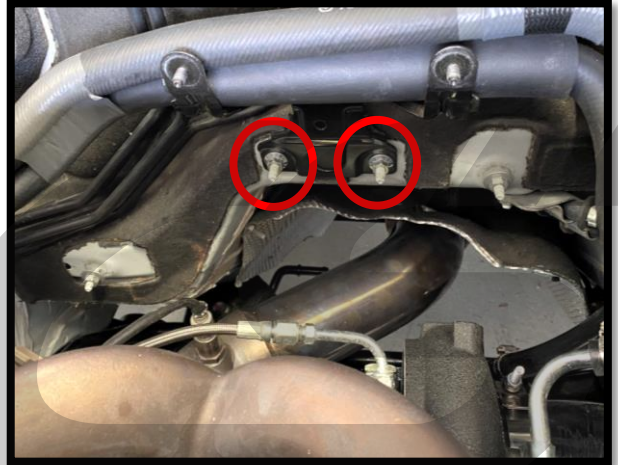


Figure 23b

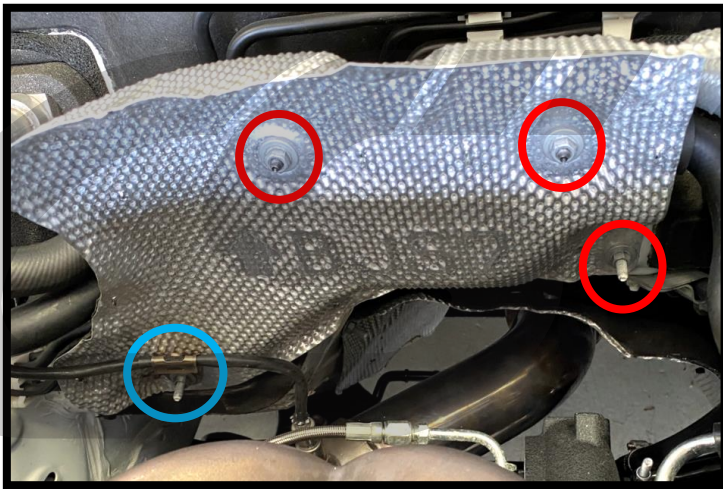


Figure 23c

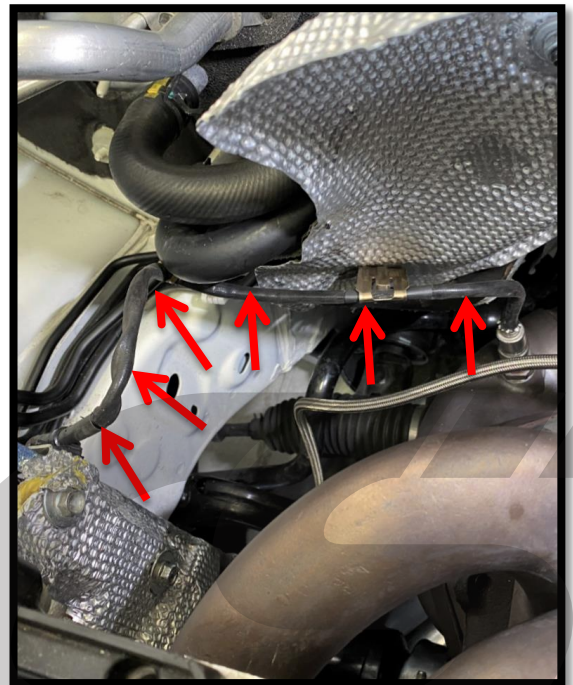


Figure 23d

- e) Bend the wiring clip and/or the OEM heatshield as needed until the O2 wiring is not rubbing on the heatshield or any other components. Finally, plug in the O2 wiring. Shown completed in **Figure 23d**.

## DETAILED INSTRUCTIONS:

### 24. Vehicle Wiring: Boost Gauge

**NOTE**

For the following wiring sections, various trim panels in the interior may need to be removed in order to hide wire routing. As everyone will locate their boost gauge and boost controller in different locations, we have not included directions for interior trim removal. There are extensive videos online for removing trim panels on these vehicles.

**NOTE**

Most of the wiring will occur in the drivers footwell. The grommet through the firewall is in this location, as is a fuse panel that can be used to source power for the various devices.

**NOTE**

For the following sections, if extra wiring is needed, ensure the wiring size matches what is provided in the kit.

- a) **Following the CS instructions provided with your boost gauge, position the boost gauge in your preferred location and mount it using the supplied mount.** We chose an easily visible spot just to the side of the navigation screen, as shown in **Figure 24a**. Other gauge pods can also be used if desired.
- b) **Plug in the supplied boost pressure sensor and power wires into the boost gauge and route them from the gauge down into the drivers footwell.** To get the wires from our gauge location downwards, we had to slightly notch the OEM trim as shown in **Figure 24b**.
- c) **Find a good location for the boost gauge sensor and secure it in position.** We were able to place it in the driver's footwell, near the firewall grommet the boost reference line passes through. Ensure the sensor wiring we attached to your gauge earlier can reach the boost gauge sensor.
- d) **Locate the boost pressure signal that was passed through the firewall in an earlier step.** Using the tee fitting that came with the boost controller, place a tee fitting in this line and connect the barb of the boost pressure sensor to one end of the tee fitting with some of the extra hose. Ensure these hoses cannot get kinked or cut during vehicle operation.



**Figure 24a**



**Figure 24b**

## DETAILED INSTRUCTIONS:

### 24. Vehicle Wiring: Boost Gauge (continued)

- e) The power wires will need to be connected to your vehicle's fuse panel. Follow the basic wiring diagram shown in **Figure 24c** and the instructions that came with your boost gauge. Additional information for wiring connections can be seen in **Figure 24d**.



The fuse panel is located behind a small access panel on the left side of the driver's footwell. **Figure 24d** has a description for each location in the fuseblock for Mazda 3.



**Mazda 6 fuseblock is similar but the fuses are going to be in different positions than shown below. Verify the recommended fuses listed have the correct power (switched or full time power) and the fuse tap will fit behind your fuse cover before completing any wire connections.**

\_\_\_\_\_

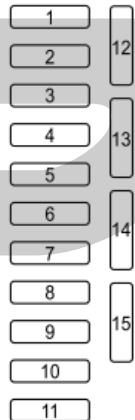
**Red Wire:** Attach to 12V. This is a location that is powered when the ignition is **ON or OFF**. We recommend using the supplied fuse tap in the #2 "D.LOCK" fuse location (shown in **Figure 24d**).

\_\_\_\_\_

**Black Wire:** Attach to a chassis ground. Use the ring terminal supplied with the Turbosmart kit. This ring terminal can be shared with the gauge, tach adapter, and boost controller.

**Figure 24c**

Fuse block (Left side)



	DESCRIPTION	FUSE RATING	PROTECTED COMPONENT
1	P.WINDOW3 P.SEAT D	30 A	Power seat*
2	D.LOCK	25 A	Power door locks
3	P.WINDOW2	25 A	Power windows
4	SEAT WARM	20 A	Seat warmer*
5	R.OUTLET3	15 A	Accessory sockets
6	SRS2/ESCL	15 A	Air bag
7	SUNROOF	10 A	Moonroof*
8	M.DEF	7.5 A	Mirror defogger*
9	R.OUTLET1	15 A	—
10	MIRROR	7.5 A	Power control mirror
11	F.OUTLET	15 A	Accessory sockets
12	ABS IG AT IND	7.5 A	AT shift indicator*
13	SRS1	7.5 A	—
14	METER1	10 A	—

**Figure 24d**



## DETAILED INSTRUCTIONS:

### 24. Vehicle Wiring: Boost Gauge (continued)

- f) The remaining white and orange wires in the power wires are used for the display color of the gauge. Follow the guide in **Figure 24e** to setup the gauge color how you would prefer.



A "switched" or "Acc." power circuit is a location that is only powered when the ignition is switched ON. For switched power, we recommend the #9 "R. OUTLET 1" location in the fuse panel. This can be seen in **Figure 24d** on the previous page.



Depending on your vehicle's trim level, the #9 "R. OUTLET 1" location may not have a fuse present. If this is the case, place a 15A fuse in the open slot on the supplied fuse tap before installing the fuse tap in location #9. A spare 15A fuse is located on the underside of the lid of the engine compartment fuse panel.



We have not setup our gauge to change color at night time as we prefer the "white" gauge color full time. It matches well with the OEM gauges on our 2018 GT. You will need to locate the headlight circuit yourself if planning on having a dual color gauge.

Gauge Face Lighting Diagram		
Day Time	Night Time	Power Wire Setup
White	White	White Wire - Connect to Acc. Power Circuit Orange Wire - Do Not Connect
Amber	Amber	White Wire - Do Not Connect Orange Wire - Connect to Acc. Power Circuit
White	Amber	White Wire - Connect to Acc. Power Circuit Orange Wire - Connect to Running Light Circuit
Amber	White	White Wire - Connect to Running Light Circuit Orange Wire - Connect to Acc. Power Circuit

**Figure 24e**

- g) Tuck any unused and/or excess wiring out of the way and secure it with zip ties. Ensure no wiring can get caught during vehicle operation.

## DETAILED INSTRUCTIONS:

### 25. Vehicle Wiring: Tach Adapter

- a) Locate your Split Second Tach Adapter and remove the two Phillips screws from the black plastic body. Remove the back cover. Shown removed in **Figure 25a**.
- b) Set the #2, #3, and #4 switches to "ON". This is the correct setting for a 4cylinder engine of this ignition type for use with the Turbosmart boost controller. Shown complete in **Figure 25a**.
- c) Once complete, reinstall the cover and tighten the Phillips screws until snug.
- d) The Tach Adapter will need to be connected to your vehicle's fuse panel. Follow the basic wiring diagram shown in **Figure 25b**.



**Figure 25a**

**Red Wire:** Attach to switched 12V. This is a location that is only powered when the ignition is switched ON. We recommend using the supplied fuse tap in the #11 "F. OUTLET" fuse location (shown in **Figure 24d**). NOTE: We share this fuse tap with switched power for the boost controller in later steps.

**Black Wire:** Attach to a chassis ground. Use the ring terminal supplied with the Turbosmart kit. This ring terminal can be shared with the gauge, tach adapter, and boost controller.

**Tan Wire:** Attach to the gray wire that was fed through the firewall earlier. This gives the Tach Adapter RPM signal. Use the "solder & seal" style of connector for an easy attachment.

**Gray Wire:** Leave disconnected & long for right now, this will be attached in the next section.

**Yellow Wire:** This wire is not used for this application. It can be cut short or coiled and positioned out of the way. Ensure it cannot short out on the vehicle.

**Figure 25b**

- f) Position the Tach Adapter out of the way where it will be safe and will not be impacted during vehicle function. It does not need to be accessed later. Secure any excess wiring & ensure no wiring can get caught during vehicle operation.



We were able to position our Tach Adapter in the drivers footwell and zip tie it to secure it out of the way of the pedals and driver's feet.

## DETAILED INSTRUCTIONS:

### 26. Vehicle Wiring: Turbosmart Boost Controller

- a) Position your boost controller somewhere in the vehicle that is out of the way, yet is still easily accessed for later adjustments. The Turbosmart kit comes with 3M tape to make secure mounting easy. We positioned ours in the center console using a 3D printed mount as shown in **Figure 26a**.
- b) Using the supplied hose, connect the boost controller to the boost reference tee that was setup under the dash earlier. The brass reducer fitting and small diameter tubing in the Turbosmart kit will be needed to connect to the boost controller. **Ensure this hose cannot get kinked or cut.**
- c) Connect the wiring harness to the boost controller and route it along the boost reference line, back to the driver's footwell.
- d) The boost controller will need to be connected to your vehicle's fuse panel. Follow the basic wiring diagram shown in **Figure 26b**.



**Figure 26a**

**Red Wire:** Attach to switched 12V. This is a location that is only powered when the ignition is switched ON. We recommend using the supplied fuse tap in the #11 "F. OUTLET" fuse location (shown in **Figure 24d**). NOTE1: we share this fuse tap with switched power for the Tach Adapter from previous steps. NOTE2: if using more than a 5AMP fuse, the supplied Turbosmart fuse holder must be used for protection of the boost controller.

**Black Wire:** Attach to a chassis ground. Use the ring terminal supplied with the Turbosmart kit. This ring terminal can be shared with the gauge, tach adapter, and boost controller.

**Yellow Wire:** Attach to the gray wire that left long during Tach Adapter install earlier. This gives the boost controller an RPM signal from the tach adapter.

**Brown Wire:** Connect to one of the black boost control solenoid wires. These are the two wires that are glued together and were fed through the firewall earlier. Which black wire the brown connects to does not matter.

**Gray Wire:** Connect to the other black boost control solenoid wire.

**Green, Orange, & White Wires:** These wires are not used for this application. They can be cut short or coiled and positioned out of the way. Ensure they are insulated and cannot short out on each other or the vehicle.

**Figure 26b**

## **DETAILED INSTRUCTIONS:**

---

### **26. Vehicle Wiring: Turbosmart Boost Controller (continued)**

- e) Secure any excess wiring & ensure no wiring can get caught during vehicle operation.
- f) Leave the trim panels off for right now in case any wiring needs to be accessed during first startup.

### **27. Fluids & Final Checks**

- a) Verify the new oil filter is installed and is tight.
- b) Fill the vehicle with approximately 5 Quarts of 5W-30 dexos2 synthetic motor oil. Check the oil level at 4.5 Quarts and slowly add more until the oil level is at the full mark on the dipstick. Ensure the vehicle is level while filling & checking the oil.



We require switching to a 5W-30 oil for greater engine protection for the increased load that comes from turbocharging a vehicle. We also recommend dexos2 certified oil to ensure the oil is rated to handle the fuel dilution that is common with direct injected cars. Ensure the oil is changed every 5,000 miles or less.




- c) Verify the radiator drain plug is tight and all coolant lines are secured with clamps.
- d) Refill the radiator using the coolant that was removed earlier. Squeeze the radiator hoses as you go to help remove air bubbles from the system. Add any excess coolant to the overflow tank. If more coolant is needed, ensure you use FL-22 or compatible coolant.
- e) Connect the new battery to the vehicle. Positive terminal first, then negative.
- f) Double check the electrical components installed earlier:
  - i. Without starting the vehicle, turn the ignition on.
  - ii. Verify the boost gauge turns on and completes its startup cycle.
  - iii. Adjust the needle using a 2mm Allen wrench in the hole in the back of the boost gauge. When the ignition is on but the car is off, the boost gauge should read zero.
  - iv. Verify the Turbosmart boost controller is on.


## DETAILED INSTRUCTIONS:


### 28. Turbosmart Boost Controller Setup for 80mm Exhaust

 For additional details, your Turbosmart Boost Controller instructions can be found at this link:  
<https://www.turbosmart.com/wp-content/uploads/2013/07/TS-0302-1002-EBS-40psi-JUL-12.pdf>

 **The below boost controller settings are for customers with a CS 80mm Exhaust. If you have a smaller exhaust or OEM exhaust, please see the next two pages.**

- a) Follow the "Boost Controller Setup" video in this playlist for detailed instructions for setting up and using the boost controller on your vehicle: <https://www.youtube.com/playlist?list=PLoqBtwyNXuhFMXJ5y6Wsfon5im6GQC19>
- b) For reference, the boost control settings we recommend are shown below. These are the same as the ones shown in the video linked above:
- obS: 10.5
  - CYL: 4
  - SCL: psi
  - dnn: 3  The "dnn" setting can be adjusted as desired. This is the brightness of the boost controller display.
  - AU: not used
  - SL: SP1 (not used)
  - Cor: On  If desired, you can set the "rL" value to a desired shift RPM and the boost controller display will flash when this RPM value is reached. This can be used like a shift light. For reference, the redline in the CorkSport OTS tune is set to 6300-6500RPM. A good setting to use as a shift light is "060" for 6000RPM.
  - Pin: 000
  - rL: 000
  - ZEr: 0.0
  
  - BG1 & BG2:
    - SP1: 25
    - GP1: 00.5
    - Sn1: 20  We strongly recommend setting BG1 and BG2 to the same values. That way your car will have the same performance if the boost group is accidentally changed.
    - FAC: 25
    - RP1: 040
    - RP2: 058
- c) These boost settings produced ~9.5psi of peak boost on a vehicle equipped with a CorkSport 80mm exhaust.

 These boost control settings were carefully chosen to provide good power characteristics with minimal risk of engine damage. Vehicles operated consistently at higher elevations may need to slightly adjust the boost controller to hit the peak ~9.5psi of boost pressure. See the video linked above for full details.

 Vehicles equipped with Automatic Transmissions may need to increase the SP1 value slightly to reach 9.5psi boost peak. This value must be adjusted very slowly to prevent over-boosting.




 **Do not modify boost controller settings to increase boost pressure above ~9.5psi peak. This is designed to be a safe level for both the engine and fuel system. Increasing boost pressure further is likely to cause engine knock, fuel cut, and/or engine damage.**


## DETAILED INSTRUCTIONS:


### 29. Turbosmart Boost Controller Setup for 60.5mm Exhaust

 For additional details, your Turbosmart Boost Controller instructions can be found at this link:  
<https://www.turbosmart.com/wp-content/uploads/2013/07/TS-0302-1002-EBS-40psi-JUL-12.pdf>

 **The below boost controller settings are for customers with a CS 60.5mm Exhaust. If you have a larger exhaust or OEM exhaust, please see the previous or next page respectively.**

- a) Follow the "Boost Controller Setup" video in this playlist for detailed instructions for setting up and using the boost controller on your vehicle: <https://www.youtube.com/playlist?list=PLoqBtwyNXuhFMXJ5y6Wsfon5Iim6GQC19>
- b) For reference, the boost control settings we recommend are shown below. These are the same as the ones shown in the video linked above:
- obS: 10.5
  - CYL: 4
  - SCL: psi
  - dnn: 3  The "dnn" setting can be adjusted as desired. This is the brightness of the boost controller display.
  - AU: not used
  - SL: SP1 (not used)
  - Cor: On  If desired, you can set the "rL" value to a desired shift RPM and the boost controller display will flash when this RPM value is reached. This can be used like a shift light. For reference, the redline in the CorkSport OTS tune is set to 6300-6500RPM. A good setting to use as a shift light is "060" for 6000RPM.
  - Pln: 000
  - rL: 000
  - ZEr: 0.0
  
  - BG1 & BG2:
    - SP1: 25
    - GP1: 00.5
    - Sn1: 20  We strongly recommend setting BG1 and BG2 to the same values. That way your car will have the same performance if the boost group is accidentally changed.
    - FAC: 75
    - RP1: 040
    - RP2: 058
- c) These boost settings produced 9-9.5psi of peak boost on a vehicle equipped with a CorkSport 60.5mm exhaust.

 These boost control settings were carefully chosen to provide good power characteristics with minimal risk of engine damage. Vehicles operated consistently at higher elevations may need to slightly adjust the boost controller to hit the peak 9-9.5psi of boost pressure. See the video linked above for full details.

 Vehicles equipped with Automatic Transmissions may need to increase the SP1 value slightly to reach 9.5psi boost peak. This value must be adjusted very slowly to prevent over-boosting.




 **Do not modify boost controller settings to increase boost pressure above 9-9.5psi peak. This is designed to be a safe level for both the engine and fuel system. Increasing boost pressure further is likely to cause engine knock, fuel cut, and/or engine damage.**


## DETAILED INSTRUCTIONS:


### 30. Turbosmart Boost Controller Setup for OEM Exhaust

 For additional details, your Turbosmart Boost Controller instructions can be found at this link:  
<https://www.turbosmart.com/wp-content/uploads/2013/07/TS-0302-1002-EBS-40psi-JUL-12.pdf>

 **The below boost controller settings are for customers with an OEM Exhaust. If you have a larger exhaust, please see the previous two pages.**

- a) Follow the "Boost Controller Setup" video in this playlist for detailed instructions for setting up and using the boost controller on your vehicle: <https://www.youtube.com/playlist?list=PLoqBtwyNXuhFMXJ5y6Wsfon5im6GQC19>
- b) For reference, the boost control settings we recommend are shown below. These are the same as the ones shown in the video linked above:
- obS: 10.5
  - CYL: 4
  - SCL: psi
  - dnn: 3  The "dnn" setting can be adjusted as desired. This is the brightness of the boost controller display.
  - AU: not used
  - SL: SP1 (not used)
  - Cor: On  If desired, you can set the "rL" value to a desired shift RPM and the boost controller display will flash when this RPM value is reached. This can be used like a shift light. For reference, the redline in the CorkSport OTS tune is set to 6300-6500RPM. A good setting to use as a shift light is "060" for 6000RPM.
  - Pin: 000
  - rL: 000
  - ZEr: 0.0
  
  - BG1 & BG2:
    - SP1: 25
    - GP1: 00.5
    - Sn1: 20  We strongly recommend setting BG1 and BG2 to the same values. That way your car will have the same performance if the boost group is accidentally changed.
    - FAC: 99
    - RP1: 040
    - RP2: 058
- c) These boost settings produced ~8psi of peak boost on a vehicle equipped with an OEM exhaust.

 With an OEM exhaust, the 8psi of peak boost is the maximum that can be produced without changes to the turbocharger system. For customers at higher elevations, you may not hit the 8psi peak due to the decreased air density.

 Vehicles equipped with Automatic Transmissions may need to increase the SP1 value slightly to reach above boost peak. This value must be adjusted very slowly to prevent over-boosting.

 **Do not modify boost controller settings to increase boost pressure above ~8psi peak. This is designed to be a safe level for both the engine and fuel system. Increasing boost pressure further is likely to cause engine knock, fuel cut, and/or engine damage.**

## DETAILED INSTRUCTIONS:

### 31. Tuning Software, Tactrix, & Tune Setup

**NOTE** If you have not sent your OEM tune to CorkSport by this point, please do so ASAP. It may take up to 3 business days for CorkSport to generate an OTS tune matched to your vehicle. Please follow the "tune setup video" in the YouTube playlist at this link for details on retrieving your OEM tune:  
<https://www.youtube.com/playlist?list=PLoqBtwyNXuhFMXJ5y6Wsfon5lim6GQCi9>

**NOTE** Tuning will require the use of a Tactrix Openport 2.0 adapter (supplied with your kit) & a laptop. For correct operation, the drivers for the Tactrix adapter must be installed on your computer. Frequently, these are installed automatically when the Tactrix is first plugged in to the computer & vehicle. If having issues connecting to your vehicle, download the drivers at this link:  
[https://www.tactrix.com/index.php?option=com\\_content&view=category&layout=blog&id=38&Itemid=61](https://www.tactrix.com/index.php?option=com_content&view=category&layout=blog&id=38&Itemid=61)

**NOTE** CorkSport offers an off the shelf (OTS) tune using MazdaEdit. We assume most people purchasing the turbo kit have already tuned their vehicle. If you have not, we sell MazdaEdit licenses separately on our website.

**NOTE** Further tuning to optimize the tune for your vehicle & climate is available from DramaTuned. Self tuning and/or using a different tuner will void your CorkSport warranty.

- Carefully follow the "Tune Setup Video" in the playlist linked at the top of this page in order to upload your CorkSport OTS tune to your vehicle.
- MazdaEdit should automatically determine which type of ECU you have in your Mazda (Denso or Mitsubishi) when downloading your OEM tune. The ECU type should stay selected so you are uploading the correct CorkSport OTS tune. If it does not or if you are not sure, it is easy to identify your ECU type as shown below:



Figure 29a  
(DENSO ECU)



Figure 29b  
(MITSUBISHI ECU)



## DETAILED INSTRUCTIONS:

---

### 32. First Startup & Reassembly



During first startup, there will be smoke and a smell coming from the exhaust manifold and turbocharger. This is normal and is simply the oils from manufacturing burning off.



Your normal octane of fuel is OK for initial startup. Before driving the vehicle hard, fill your tank with 91, 92, or 93 octane fuel. Premium octane fuel **MUST** be used for proper vehicle operation with the CS turbo kit.



Use the first start checklist that came with your advisory sheet before starting your vehicle.

- a) **Start the vehicle.** You will want to immediately look for any oil and coolant leaks. If any leaks are present, the vehicle must be shut off immediately so you can fix any and all issues.
  
- b) **Let the vehicle run for 10-15 minutes to warm it up.** Check the boost controller during this process and verify the RPM is reading correctly. It will read in RPM/100. For example, at normal idle, you should see approximately "007" to "008". Slowly rev the vehicle and you should see the RPM change. At 2200 RPM for example you should see "022".
  
- c) **Once the vehicle has warmed up and you are confident it is running correctly and there are no leaks, you can move on to reassembly of the bumper, cowl, hood, & under tray.**
  
- d) **Follow sections 1, 4, and 5a-5d in reverse to reassemble the vehicle.** For all components, torque specs are listed below:
  - 8mm bolts/nuts: Tighten until snug
  - 10mm bolts/nuts: Tighten to 15-17ft-lbs.
  - 12mm bolts/nuts: Tighten to 19-21ft-lbs.
  - 14mm bolts/nuts (wipers): Tighten until snug.



**This completes the installation of your CorkSport Turbo Kit.  
Double check oil and coolant levels after a few days of driving.  
Enjoy the upgraded performance!**

## DETAILED INSTRUCTIONS:

### 33. Wastegate Actuator Adjustments



This section is only meant for those working with a tuner to make horsepower beyond the CorkSport OTS tune. Please follow suggestions made by your tuner. If you make changes shown in this section without the appropriate boost controller, fueling, & tune changes, catastrophic engine damage is likely.



The OEM fuel system is safe with the CorkSport OTS tune. If boost pressure is increased using the information below, your OEM fuel system will likely become inadequate. Failure to upgrade the fuel system while making changes shown below will cause your vehicle to run lean, likely resulting in catastrophic engine damage.



Each turbocharger is setup at CorkSport with a 5psi wastegate spring and 2 turns of wastegate preload. This setup was specifically chosen to work well with our OTS tune, OEM fuel system, and boost controller settings.



Increasing preload on the wastegate will increase boost pressure across the RPM range, most notably at lower RPMs.



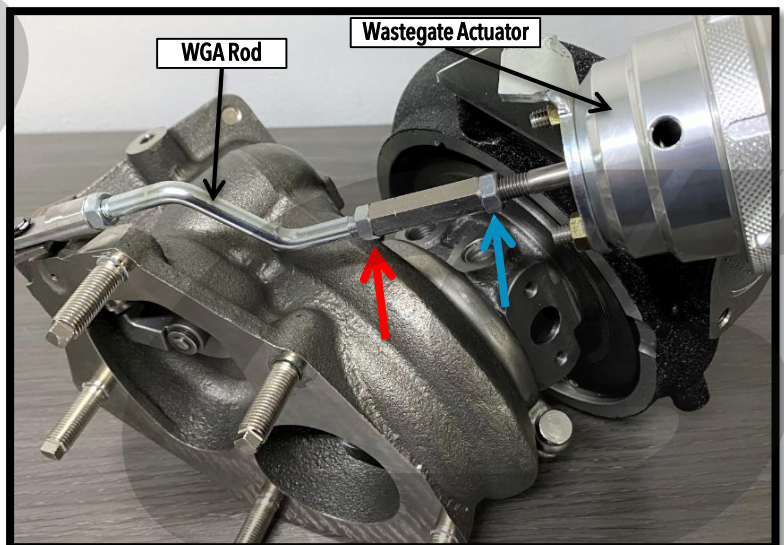
Increasing wastegate spring pressure will increase boost pressure drastically across the RPM range.



Both adjustments below are shown with the turbocharger off the car for clarity. These operations can be performed with the turbocharger installed on the vehicle.

#### Part A: Wastegate Preload Adjustment

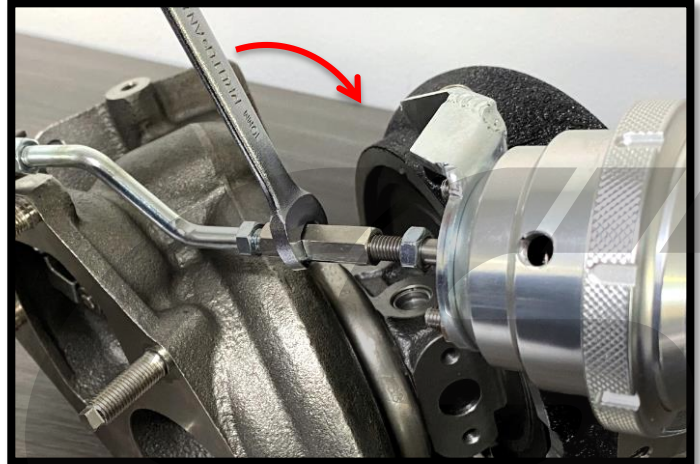
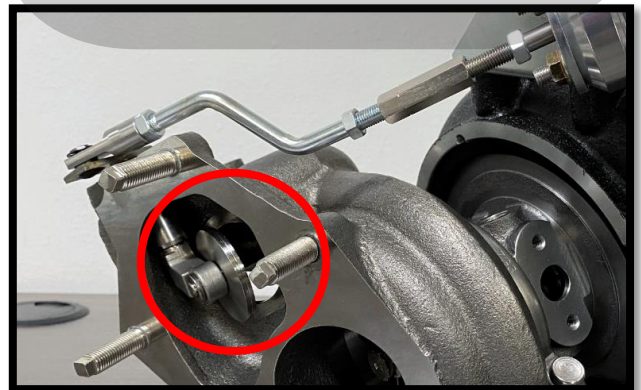
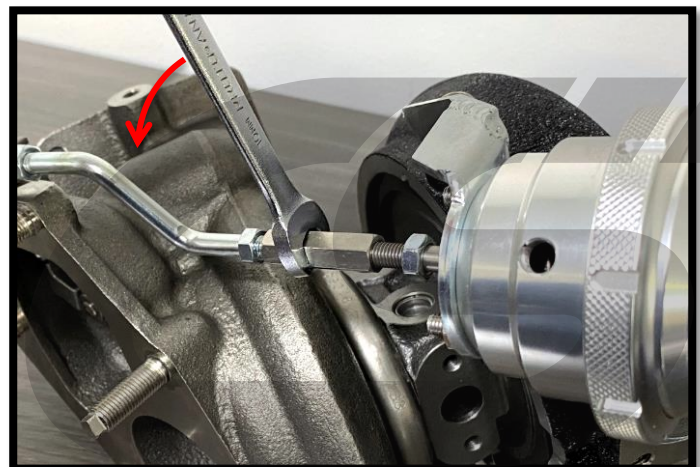
- Locate the wastegate actuator (WGA) & actuator rod. Shown in **Figure 31a**.
- Using two 10mm wrenches, break loose the jam nut shown with **red arrow** in **Figure 31a**. Use one wrench to hold the turnbuckle and the other to loosen the jam nut. This nut uses opposite thread, so it must be turned **right** to loosen.



**Figure 31a**

**DETAILED INSTRUCTIONS:****33. Wastegate Actuator Adjustments (continued)****Part A: Wastegate Preload Adjustment (continued)**

- c) Using one 10mm and one 11mm wrench, break loose the jam nut shown with **blue arrow** in **Figure 31a** on the previous page. Use the 10mm wrench to hold the turnbuckle and the 11mm to loosen the jam nut. This nut uses normal thread, so it must be turned **left** to loosen.
- d) Rotate the turnbuckle in the direction shown in **Figure 31b** using a 10mm wrench until it can be turned by hand.
- e) Loosening the turnbuckle further will open the wastegate as shown in **Figure 31c**.
- f) Tighten the turnbuckle until you can no longer turn it easily by hand. This is the "zero" point where the wastegate is closed but the spring has no preload.
- g) Using a 10mm wrench in the direction shown in **Figure 31d**, add the desired amount of pre-load. As stated before, 2 turns of pre-load is the setup we use at CS. We recommend marking the turnbuckle with a Sharpie or paint pen to make counting turns easier.
- h) Once happy with preload, re-tighten the two jam nuts against the turnbuckle.

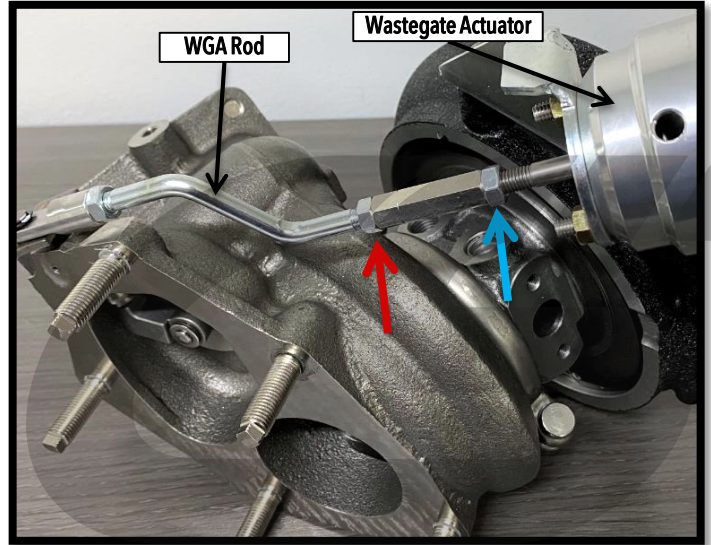
**Figure 31b****Figure 31c****Figure 31d**

## DETAILED INSTRUCTIONS:

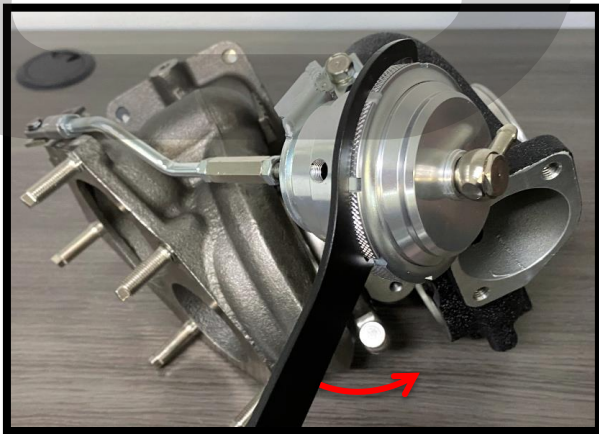
### 33. Wastegate Actuator Adjustments (continued)

#### Part B: Wastegate Spring Change

- i) Locate the wastegate actuator (WGA) & actuator rod. Shown in **Figure 31e**.
- j) Using the spanner wrench supplied in your kit, remove the metal ring from the WGA. Shown in process in **Figure 31f**.
- k) With the metal ring removed, you can remove the cap from the WGA. Shown removed in **Figure 31g**. Use caution to not damage or dirty the silicone diaphragm.
- l) Using two 10mm wrenches, break loose the jam nut shown **with red arrow in Figure 31e**. Use one wrench to hold the turnbuckle and the other to loosen the jam nut. This nut uses opposite thread, so it must be turned **right** to loosen.
- m) Using one 10mm and one 11mm wrench, break loose the jam nut shown **with blue arrow in Figure 31e**. Use the 10mm wrench to hold the turnbuckle and the 11mm to loosen the jam nut. This nut uses normal thread, so it must be turned **left** to loosen.



**Figure 31e**



**Figure 31f**



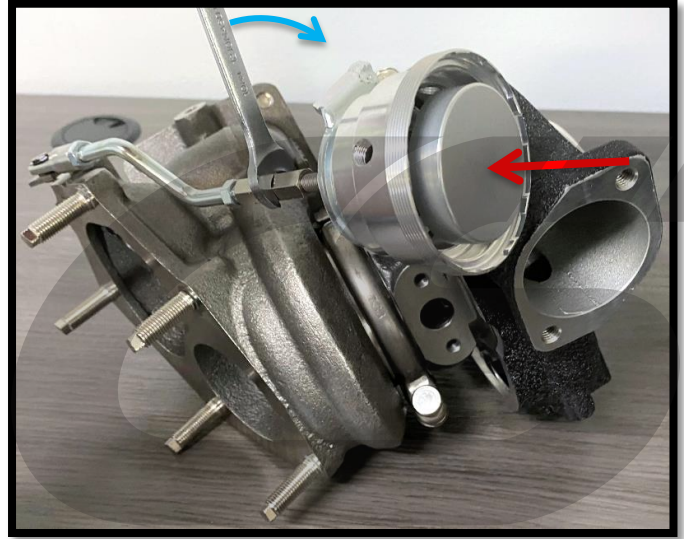
**Figure 31g**

## DETAILED INSTRUCTIONS:

### 33. Wastegate Actuator Adjustments (continued)

#### Part B: Wastegate Spring Change (continued)

- n) Use your hand to apply pressure to the wastegate piston in the direction shown with **red arrow** in **Figure 31h**.
- o) While applying pressure, loosen the turnbuckle using a 10mm wrench in the direction shown with **blue arrow** in **Figure 31h**.
- p) Keep loosening the turnbuckle until the WGA rod separates as shown in **Figure 31i**.
- q) Remove the wastegate piston assembly from the housing. Shown removed in **Figure 31j**.



**Figure 31h**



**Figure 31i**



**Figure 31j**

**DETAILED INSTRUCTIONS:**

**33. Wastegate Actuator Adjustments (continued)**

Part B: Wastegate Spring Change (continued)

- r) Remove the jam nut from the end of the wastegate piston assembly, then take apart the wastegate piston assembly. Shown disassembled in **Figure 31k**. Take note of the orientation of the components, they must go back together in the same way they came apart
  
- s) Replace the wastegate spring with the combination of springs you need to hit your spring pressure target. Reference **Figure 31l** for information on spring setups.



**Figure 31k**

Pressure Rating		3 PSI Inner	5 PSI Inner	7 PSI Middle	11 PSI Middle	10 PSI Outer	7 PSI Outer
Color		Black	Gray	Purple	Red	Blue	Pink
Desired Boost Pressure							
PSI	BAR						
3	0.207	Black					
5	0.345		Gray				
7	0.483			Purple			
10	0.69					Blue	
11	0.76				Red		
13	0.89	Black				Blue	
15	1.03		Gray			Blue	
17	1.172			Purple		Blue	
19	1.31		Gray	Purple			Pink
21	1.45				Red	Blue	
23	1.59		Gray		Red		Pink
26	1.793		Gray		Red	Blue	

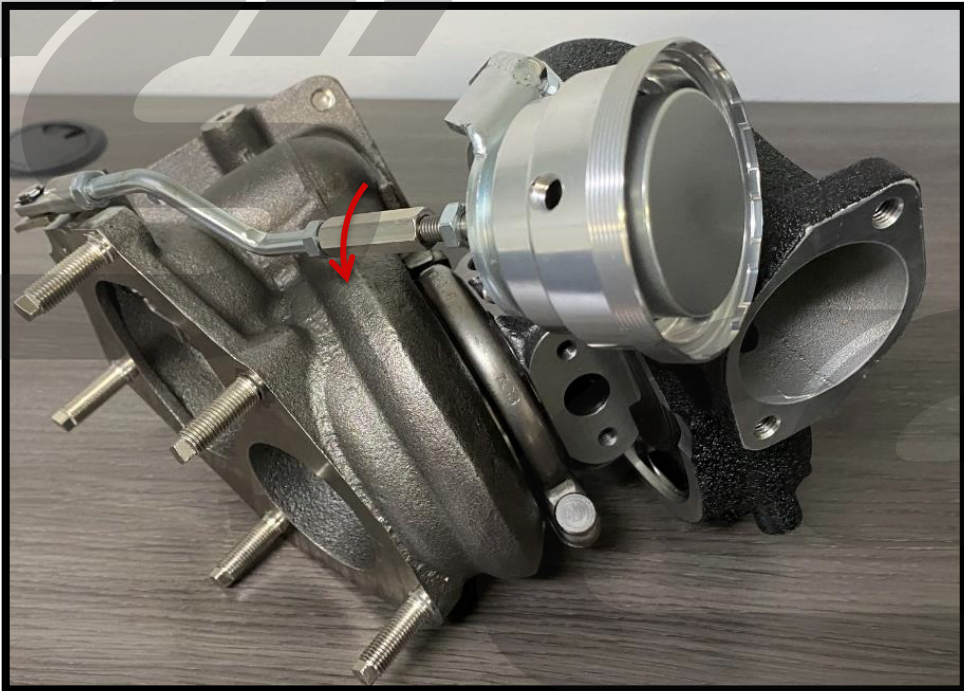
**Figure 31l**

## **DETAILED INSTRUCTIONS:**

### **33. Wastegate Actuator Adjustments (continued)**

#### Part B: Wastegate Spring Change (continued)

- t) Reassemble the wastegate piston assembly and insert it into the wastegate housing.
  - u) Compress the wastegate springs with your hand and reattach the two ends of the wastegate actuator rod. Shown completed in **Figure 31m**.
  - v) Rotate the turnbuckle in the direction shown in **Figure 31m** until the top of the wastegate piston is contained within the housing.
- NOTE** This will be way too much wastegate preload for correct operation. We tighten the turnbuckle so far to make installing the top of the WGA easy.
- w) Install the top of the WGA and secure with the metal ring removed earlier. Tighten the ring with the supplied spanner wrench.
  - x) Follow Steps 31d-31h on page 109 to correctly preload your WGA.

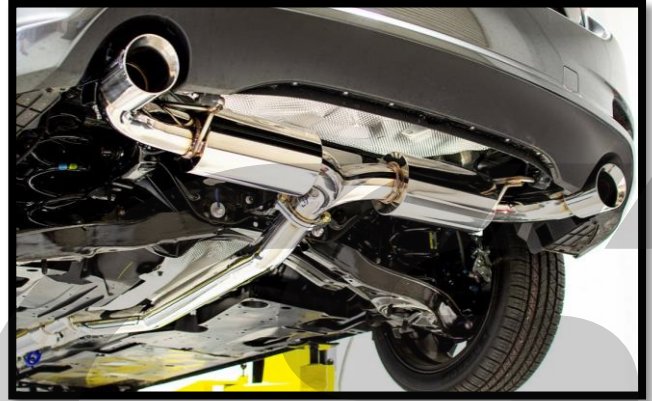


**Figure 31m**

## WHAT'S NEXT?

### CorkSport 80mm Cat Back Exhaust

Wake up your 2014-2018 Mazda 3 with the CorkSport 80mm Cat Back Exhaust. The next step up in volume from the existing 60.5mm CorkSport exhaust; the 80mm variant offers a great sounding, loud exhaust that doesn't ruin the daily drivability of the MZ3. More power, better looks, and a sound that changes a boring daily driver into a fun backroads car all come in an easy to install package. Plus, it maximizes the power potential of the CS Turbo Kit!



### CorkSport 13" Big Brake Kit

The CorkSport 13" Big Brake Kit for Mazda 3 provides a drastic improvement to braking by offering improvements to each component in the system. Larger rotors, 4-piston calipers, stainless steel brake lines, upgraded pads, and everything you need to install on your 3 is included in this kit. If the existing CorkSport Big Brake Kit was not enough for you and your MZ3, look no further than the CorkSport 13" BBK.



### CorkSport Rear Motor Mount

Driver/Vehicle connection is a key aspect for any motoring enthusiast, and CorkSport has what you need for your Mazda! If you are tired of the numb throttle response, gear shifts, and engine braking, then the CorkSport Race Rear Motor Mount is the performance part your Mazda needs. Excessive engine movement due to the sloppy OE RMM is just waste energy that could be going to the tires as well causes a delay feedback to your driving experience. The CorkSport Race RMM drastically reduces the amount of the engine movement, drastically enhancing your driving experience.

