

CorkSport Front Mount Intercooler Kit

2010 – 2013 Mazdaspeed 3

7

This package should contain:

- 1)-One (1) 2.25" Hot Side IC Pipe Multi-Bend
 - 2)-One (1) 2.25" Hot Side IC Pipe 90 Degree Bend
 - 3)-One (1) 2.50" Cold Side IC Pipe 90 Degree Bend
 - 4)-One (1) 2.50"-3.00" Cold Side IC Pipe Multi-Bend
 - 5)-One (1) Radiator Hose
 - 6)-One (1) Silicone Coupler Kit
 - 7)-One (1) T-Bolt Clamp Kit:
 - 1 – 77-85mm
 - 1 – 70-78mm
 - 5 – 63-71mm
 - 5 – 57-65mm
 - 8)-One (1) Small Core Intercooler (Small Core Kit Only)
 - 9)-Two (2) Intercooler Side Brackets
 - 10)-Two (2) M8x1.25x12mm Flange Bolts
 - 11)-Two (2) M6x1.0x25mm Flange Bolts w/Flange Nuts
- For Large Intercooler Kits Only:**
- 12)-One (1) Large Core Intercooler (shown page 2)
 - 13)-One (1) Replacement Crash Bar
 - 14)-Two (2) M8x1.25x50mm Bolts w/Washers



5



6



1



4



8

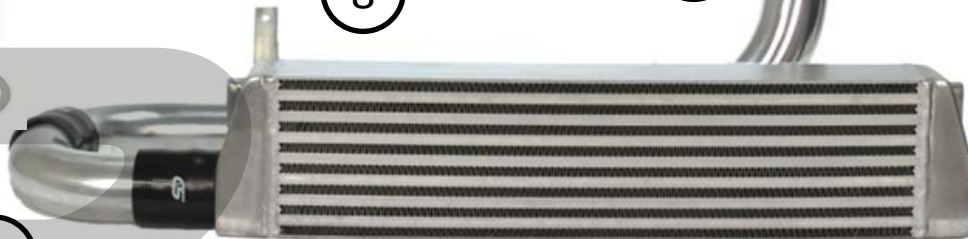

3

14



10



11



2



9

13





CorkSport Front Mount Intercooler Kit

2010 – 2013 Mazdaspeed 3

Thank you for purchasing the CorkSport Front Mount Intercooler Kit for the 2010-2013 Mazdaspeed 3. Keep your BAT's under check with the CorkSport FMIC Kit with the small or large intercooler. Please let us know what you think by submitting a review at: <https://corksport.com/mazdaspeed-3-fmic-ram-air-kit.html>



Pre-Installation Notes:



Make sure your vehicle is completely cooled down prior to starting installation. If you are going to work on your car within an hour or two of having driven it, use a fan to cool off the car.



These instructions were written for reference only and the use of a factory service manual is recommended (where applicable). Please read these instructions thoroughly prior to starting installation.



These instructions were made using a 2013 Mazdaspeed 3. Installation for earlier Mazdaspeed 3 will be similar.



Some oil catch can setups mounted on the inside of the frame rail may interfere with the hot pipe routing. Relocate the oil catch can to the outside of the frame rail for hot pipe clearance.

Materials and Time:



General Info.

Part #: AXL-6-141-10
Time Est: 4 - 6 hours
Wrench Rating: 4/5



Parts List

See cover Page



Tooling List

Flat Head Screwdriver
Phillips Head Screwdriver
Large Jaw Pliers
Needle Nose Pliers
10mm Wrench
13mm Wrench
8mm Socket
10mm Deep Socket
12mm Socket
14mm Socket
Masking Tape
Plastics Cutting Tool
(Razor, Oscillating Saw, Grinder
w/Cut Off Wheel...etc)

Additional Items (not included)

1 Gallon of Engine Coolant
1 Small Zip-Tie
Silicone-Teflon Spray

Need Help With Your Installation?
Call (360) 260-CORK



Order of Operations & Table of Contents



Disassembly

Section 1: Intercooler and Intake Removal	Pg. 2-3
Section 2: Engine Under Tray Removal	Pg. 4
Section 3: Front Bumper Removal	Pg. 5-7
Section 4: Drain Coolant and Remove Coolant Hose	Pg. 8
Section 5: OEM Air Dams Removal	Pg. 9



Intercooler Piping Installation

Section 6: Cold Pipe Installation	Pg. 10
Section 7: Hot Pipe Installation	Pg. 11-12



Small Intercooler Installation

Section 8: Small Core Intercooler Installation	Pg. 13
Section 9: 90 Degree IC Piping Installation	Pg. 14



Large Intercooler Installation

Section 10: OEM Crash Bar Removal	Pg. 15
Section 11: CorkSport Crash Bar Installation	Pg. 16
Section 12: Large Core Intercooler installation	Pg. 17
Section 13: 90 Degree IC Piping Installation	Pg. 18



Intercooler Fitment Trimming

Section 14: Bumper Trimming	Pg. 19
Section 15: Undertray Trimming	Pg. 20



BVP Installation

Section 16: BPV Installation	Pg. 21
------------------------------	--------

Detailed Instructions



These instructions were made using a 2013 Mazdaspeed 3. Installation for earlier Mazdaspeed 3 will be similar.

1. Intercooler and Intake Removal

- a) Remove the negative battery terminal and place the plastic cover back over the battery (green arrow in Figure 1a).



Figure 1a

- b) Remove the two 10mm bolts fastening intercooler shroud to the intercooler. Push the shroud towards the firewall to unhook it and remove it from the vehicle (red circles in Figure 1b).

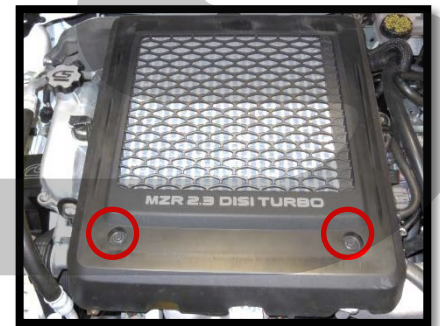

Figure 1b



We recommend using plastic Ziploc bags and a sharpie to label all bolts and parts throughout the install.

- c) Remove the clamps for the throttle body and turbo boost tubes from the intercooler. Use a 10mm socket to loosen the clamps (green circles in Figure 1c).

- d) Detach the bypass valve (BPV) from the intake. Remove the vacuum signal hose (red arrow), and the large BPV to intake hose by compressing the clamp with pliers (green arrow in Figure 1c). Leave the bypass valve attached to the intercooler pipe.

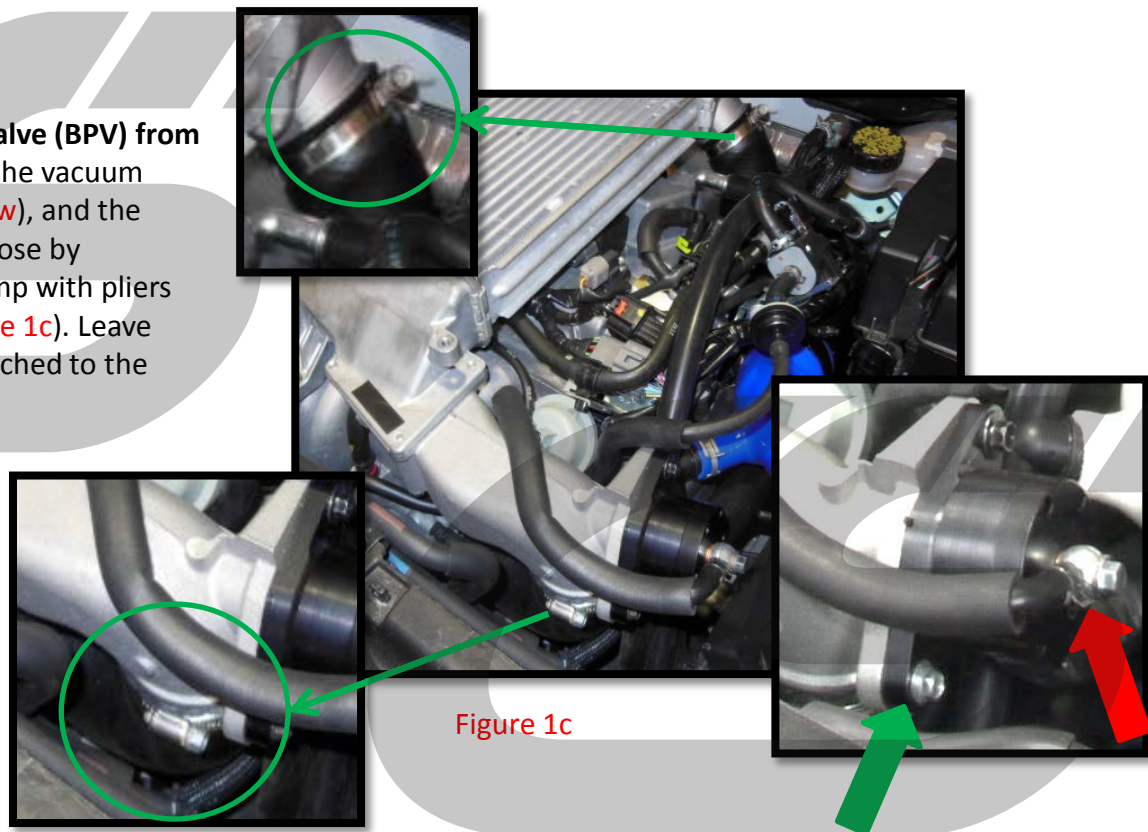

Figure 1c

1. Intercooler and Intake Removal (continued)

- e) Remove the three (3) 12mm nuts fastening the intercooler to the top of the engine and remove the intercooler from the vehicle by pulling upward (Figure 1d).



Figure 1d

- f) Remove the OEM inlet and outlet boost tubes from the engine. Use a 10mm socket and ratchet or #2 Phillips screwdriver. Figure 1e.

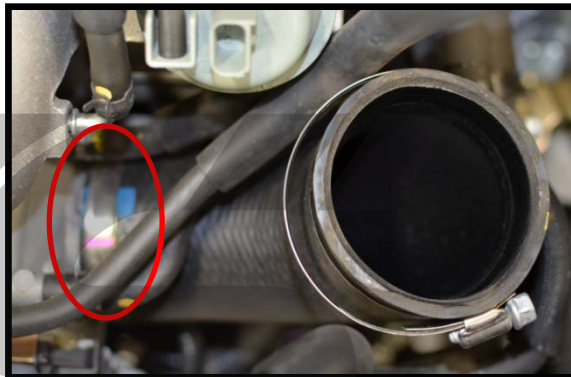

Figure 1e

- g) Please refer to the Turbo Inlet Pipe instructions for installation.

2. Under Tray Removal

- a) Remove the engine under tray with a 10mm socket and ratchet and a flat head screwdriver. Use the 10mm socket to remove the bolts circled in red and use the flat head screwdriver to remove the push clips circled in blue. (Figure 2a).

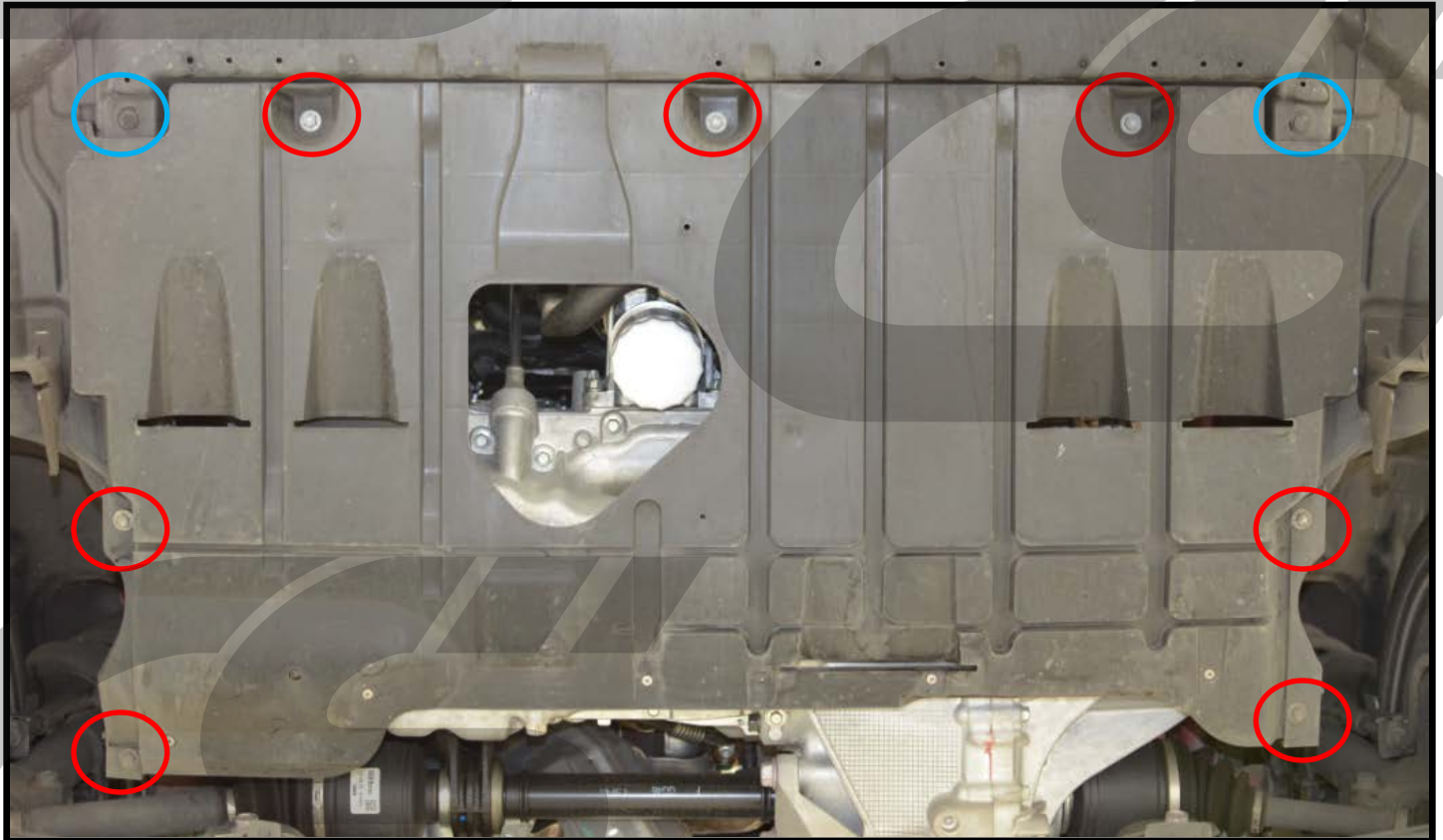

Figure 2a

3. Front Bumper Removal

- a) Remove the bumper under tray with a 8mm socket and ratchet. Use the 8mm socket to remove the screws circled in red then remove the panel (Driver's side pictured in [Figure 3a](#)).

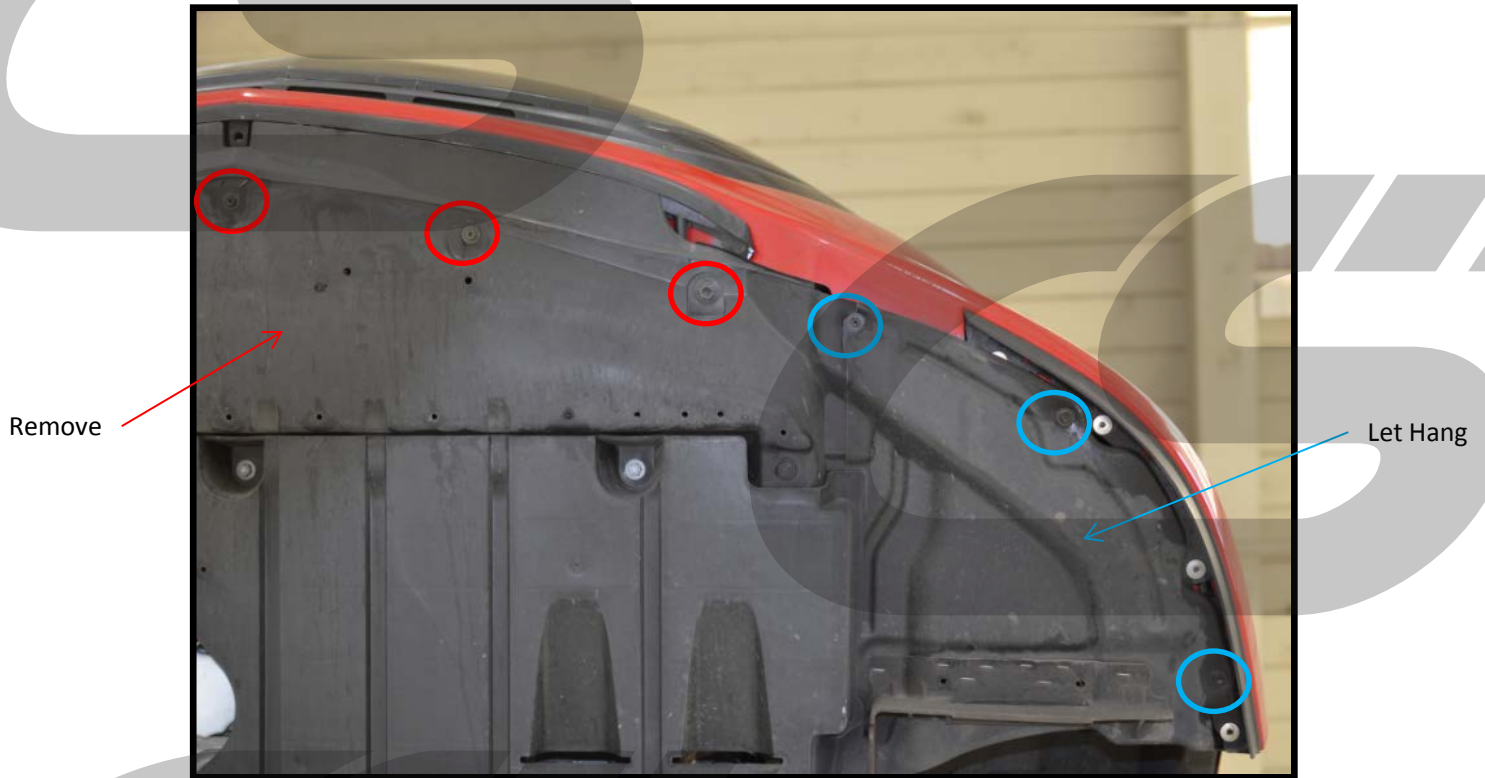

Figure 3a

- b) Loosen the lower portion of the inner fender with an 8mm socket and ratchet. Use the 8mm socket to remove the screws circled in blue then let the inner fender hang in place (Driver's side pictured in [Figure 2a](#)).

- c) Loosen the upper portion of the inner fender with a 8mm socket and ratchet and a #2 Phillips head screwdriver. Use the 8mm socket to remove the screw circled in blue and use the #2 Phillips to remove the screw clips circled in red (Passenger's side pictured in [Figure 2b](#)). Let the fender hang.

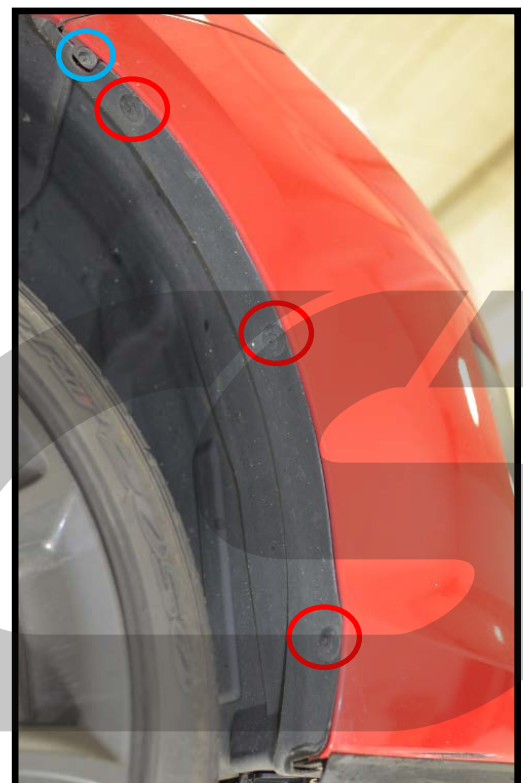

Figure 3b

Need Help With Your Installation?
Call (360) 260-CORK

3. Front Bumper Removal (continued)

- d) Disconnect the fog light wires and remove wiring from the bumper. Use a small flat head screwdriver to disengage the clip hold the strap around the wire shown with the red arrow in **Figure 3d**.



Figure 3c: Driver's Side

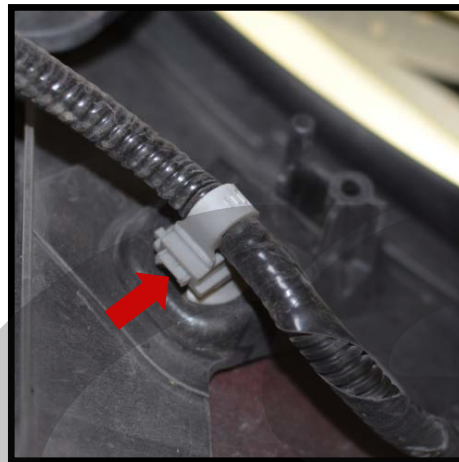

Figure 3d: Driver's Side

- e) Pull the wire up and out of the hooks. Red circles in **Figure 3e**.

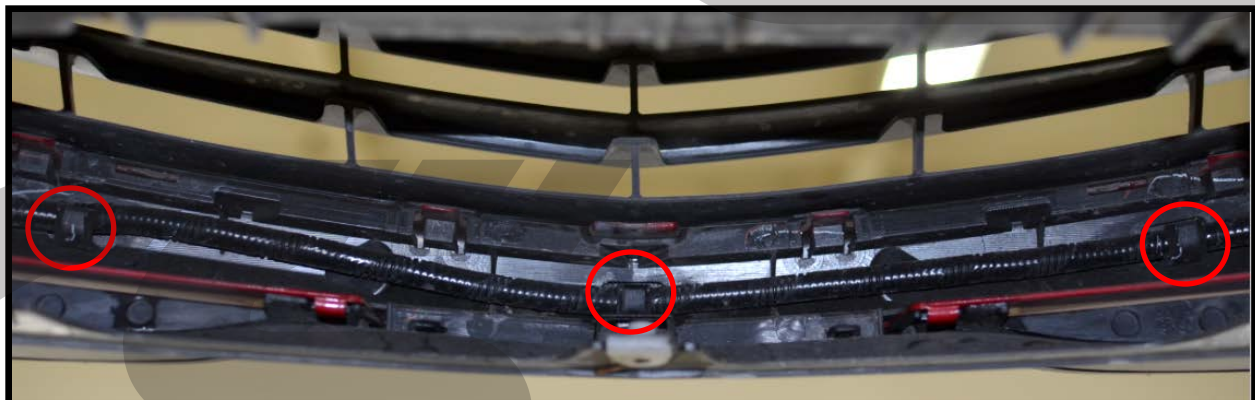

Figure 3e: Center



Figure 3f: Passenger's Side



Figure 3g: Passenger's Side

3. Front Bumper Removal (continued)

- f) **Remove the push clips and screw at the top of the bumper.** Use a flat head screwdriver to remove the push clips circled in blue and use a #2 phillips screwdriver to remove the screws circled in red shown in **Figure 3h**.

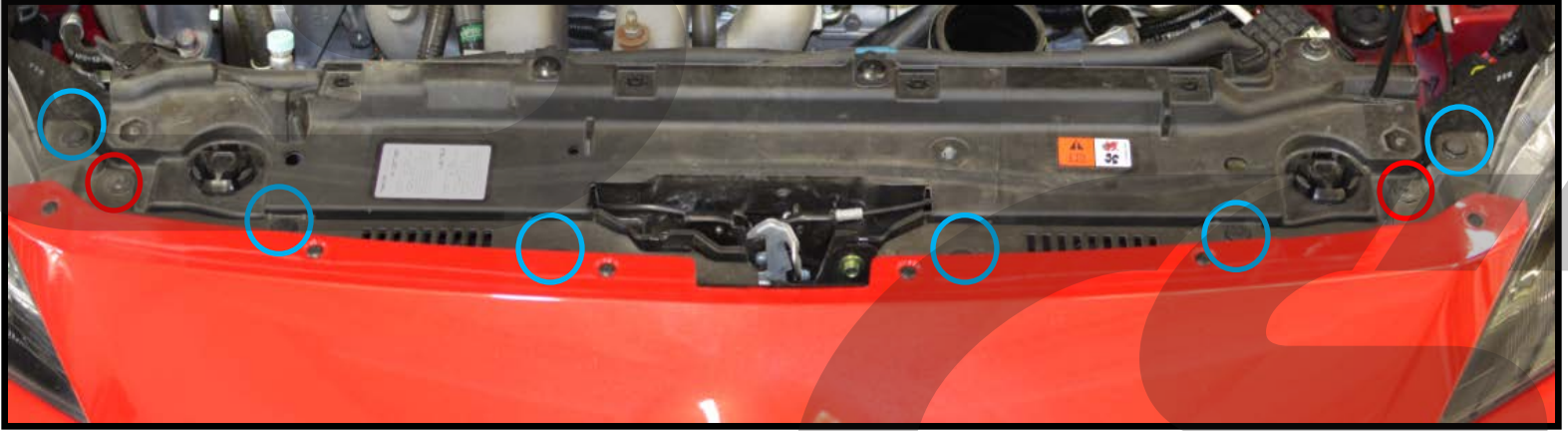

Figure 3h

- g) **Use masking tape to protect the render,** **Figure 3i.**



Figure 3i



Figure 3j

- h) **Loosen each side of the bumper.** Starting on the rearward edge of the seam, pull the bumper outward popping each clip loose. There are four clips total on each side.



Removing the bumper can be done alone, but the assistance of another person is recommended.

- i) **Remove the bumper from the car.** Once each side is loose, pull the bumper straight forward to remove.

4. Drain Coolant & Remove OEM Coolant Hose



Figure 4a



Figure 4b

- a) **Drain the coolant.** Use a large flat head screwdriver to open the drain valve located on the lower driver's side of the radiator. Drain coolant into a clean container for re-use (Figure 4a).
- b) **Remove the OEM coolant hose.** Use large jaw pliers to loosen and move the spring clamps. Pulling while twisting the hose will help break it loose (Figure 4b).
- c) **Install the CorkSport coolant hose.** Install like Figure 4c and reuse the OEM spring clamps.

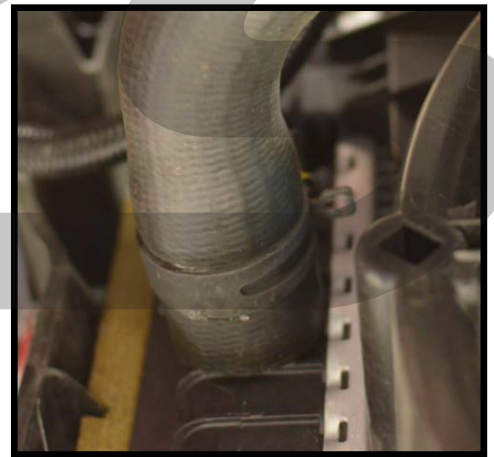

Figure 4c

5. OEM Air Dams Removal

- a) Remove the OEM air dams. Use a 10mm socket and ratchet to remove the bolts circled in red shown in Figure 5b-c.
- b) Relocate the air temperature sensor (Figure 5c) to the core support cross bar with a small zip-tie shown with the red circle in Figure 5a.

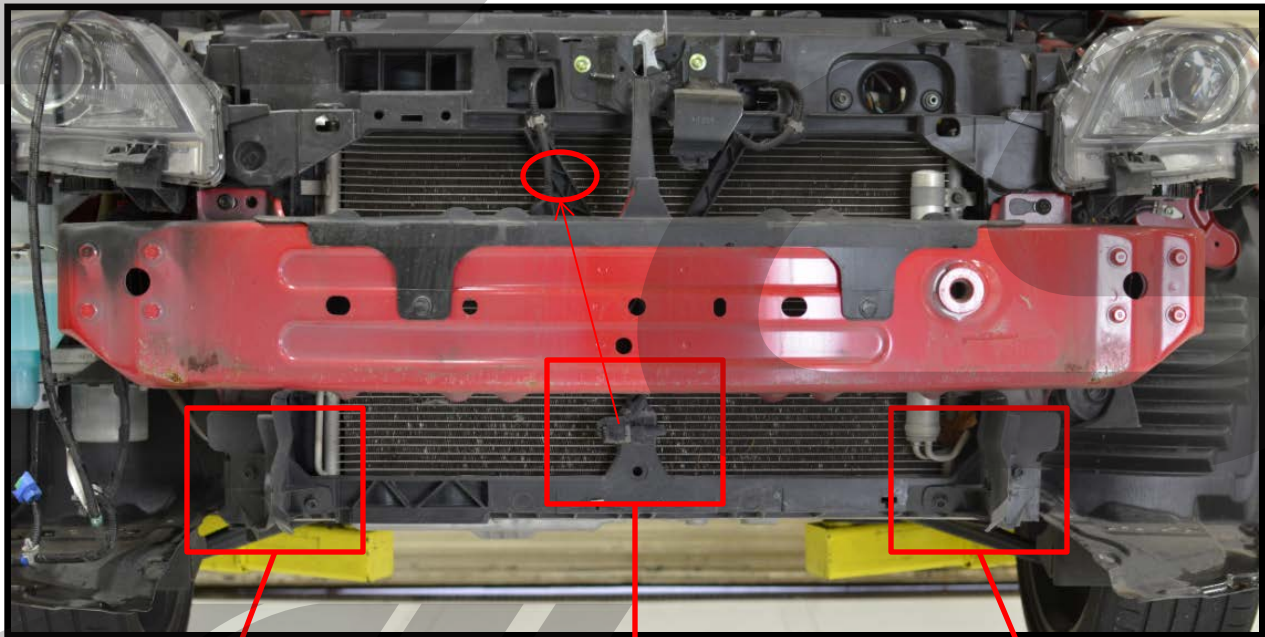

Figure 5a

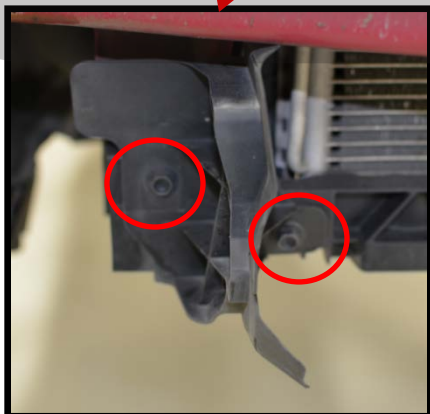

Figure 5b

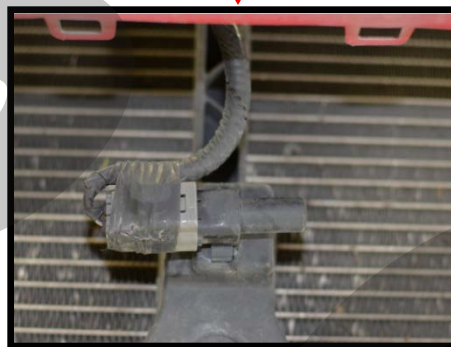

Figure 5d

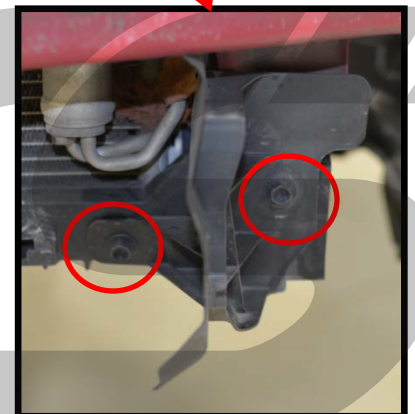

Figure 5c

6. Cold Pipe Installation

- a) **Install the throttle body silicone coupler.** Use the 2.75"-3.00" coupler with the 70-78mm and 77-85mm T-bolt clamps, respectively. Use a 10mm socket and ratchet to tighten the 70-78mm clamp on the throttle body, circled in red shown in **Figure 6a**.

70-78mm Clamp

77-85mm Clamp

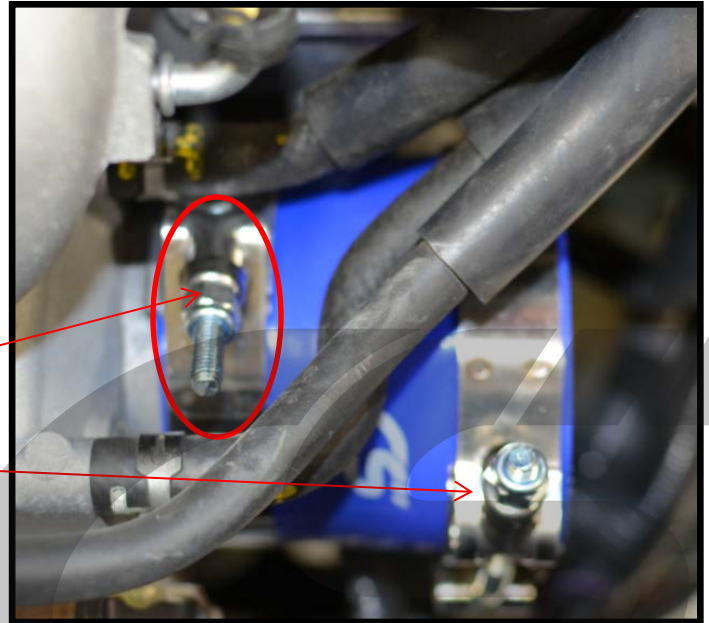

Figure 6a



The cold pipe may be touching the oil cooler hose slightly, this is normal.

- b) **Install the CS cold pipe.** Remove the lower passenger side A/C bolt using a 12mm wrench. Insert the 3.00" side of the cold pipe into the throttle body coupler then rotate up so the bracket hole aligns with the removed A/C bolt. Red arrow in **Figure 6b**.

- c) **The installed CS cold pipe is shown in Figure 6c.**

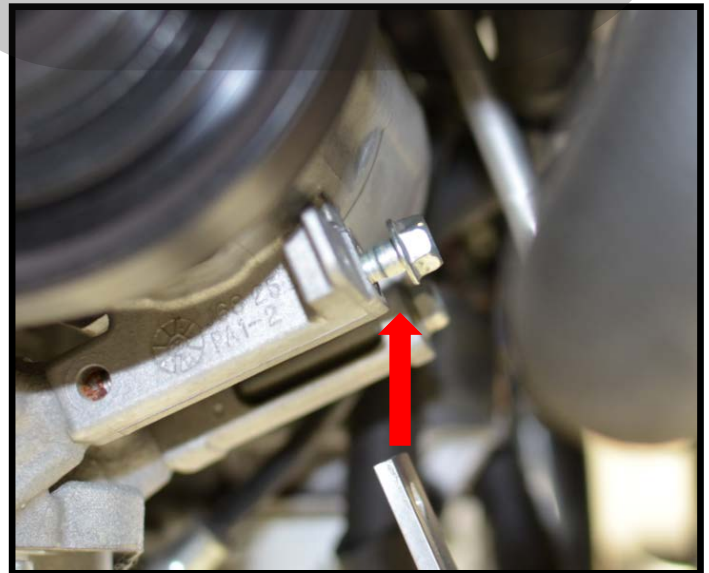
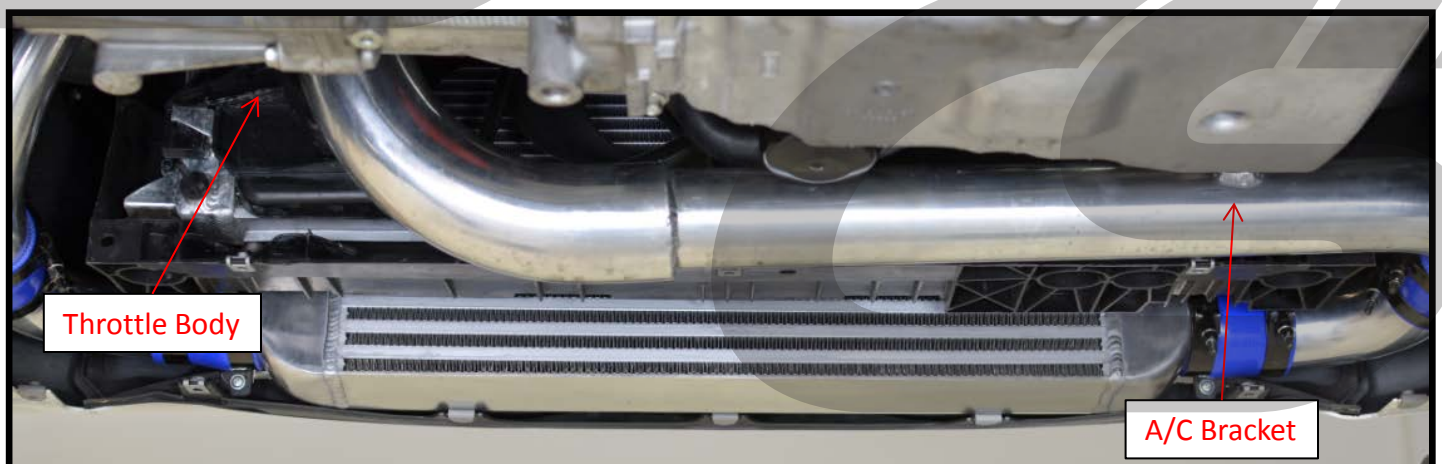

Figure 6b



Throttle Body

A/C Bracket

Figure 6c

7. Hot Pipe Installation

- a) **Remove the evap solenoid and bracket.** Use a 8mm socket and ratchet to remove the bolt circled in red shown in **Figure 7a**. Then use a 10mm socket and ratchet to remove the nut holding the bracket shown with the red arrow.



Figure 7a

- b) **Relocate the evap solenoid and bracket.** Using the provide bolt and a 10mm socket and ratchet, move the bracket to the OEM threaded hole shown with the red arrow in **Figure 7b**. Reattach the evap solenoid.

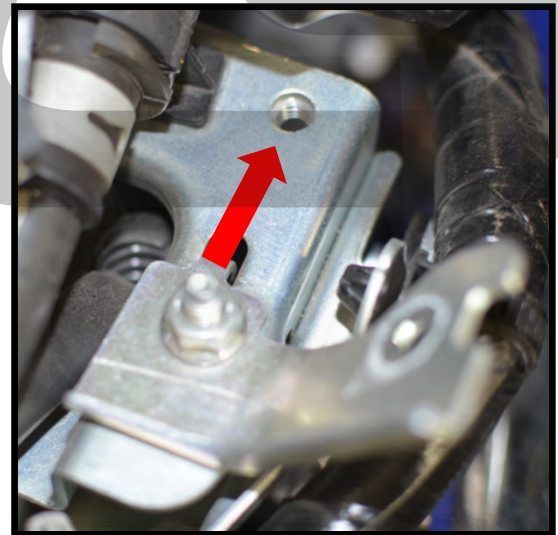

Figure 7b

- c) **Remove the shifter assembly plate bolt** using a 12mm socket and ratchet. Red circle in **Figure 7c**.

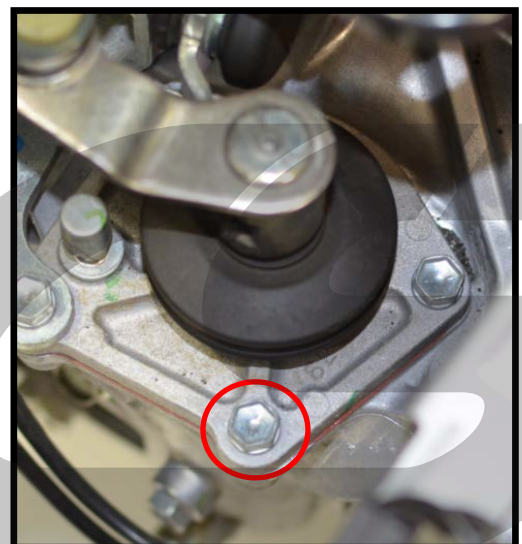

Figure 7c



Some oil catch can setups mounted on the inside of the frame rail may interfere with the hot pipe routing. Relocate the oil catch can to the outside of the frame rail for hot pipe clearance.

7. Hot Pipe Installation (continued)

- d) Position the hot pipe in the car as shown in **Figure 7d**.
- e) Install the turbo outlet silicone coupler. Use the 2.00"-2.25" coupler with the 57-65mm T-bolt clamps and leave loose, shown in **Figure 7e**.
- f) Align the upper bracket on the IC pipe with the stud and leave loose, shown in **Figure 7f**.



57-65mm Clamp

Figure 7e

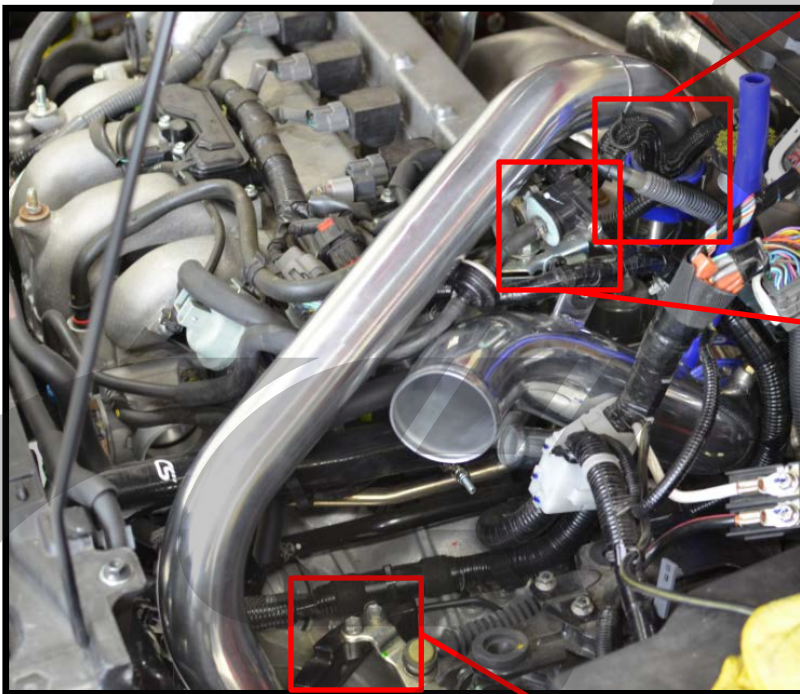

Figure 7d

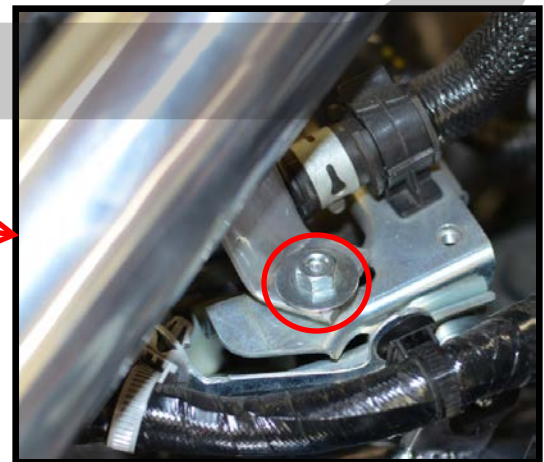

Figure 7f

- g) Align the lower bracket on the IC pipe with the bolt hole then thread in the bolt, but leave loose, shown in **Figure 7g**.
- h) Verify that everything is aligned correctly then tighten the upper and lower brackets, followed with the T-bolt clamps at the turbo outlet.



Figure 7g

8. Small Core Intercooler Installation

- a) **Attach the silicone couplers to the intercooler.** Use the 2.25"-2.50" coupler on the driver's side and a 2.50" strait coupler on the passenger's side. Use a 10mm socket and ratchet to tighten the 63-73mm T-bolt clamps.

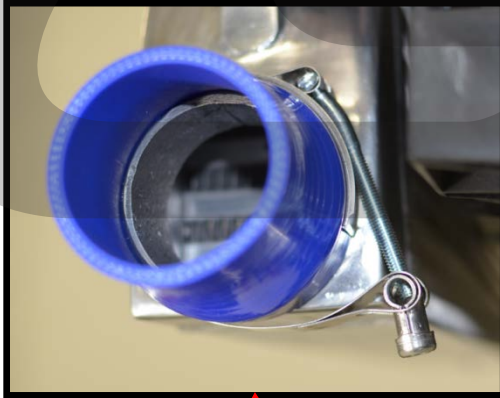

Figure 8b



If you have difficulty installing the clamp; remove the nut, position the clamp in the orientation in **Figure 8b**, then slide the clamp end over the end of the bolt.

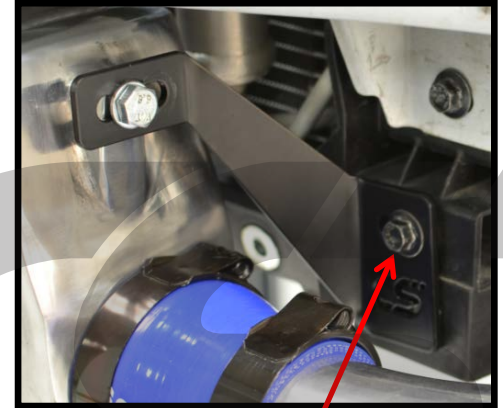

Figure 8c



Figure 8a

- b) **Mount the intercooler end brackets** with a 10mm socket and ratchet as shown in **Figure 8a & 8c**. Leave snug, not tight.
- c) **Mount the intercooler using the provided hardware.** Position the intercooler between the end brackets then thread in the provided bolts with washers. Use a 13mm socket and ratchet to snug the bolts (**Figure 8d**).
- d) **Center the intercooler and tighten the 10mm bolts** holding the end brackets using a 10mm socket and ratchet.



Leave the 13mm IC bolts snug enough to rotate and slide the IC back and forth, this will help when installing the 90 degree IC piping.



Figure 8d

9. Small Core 90 Degree IC Piping Installation



Figure 9a

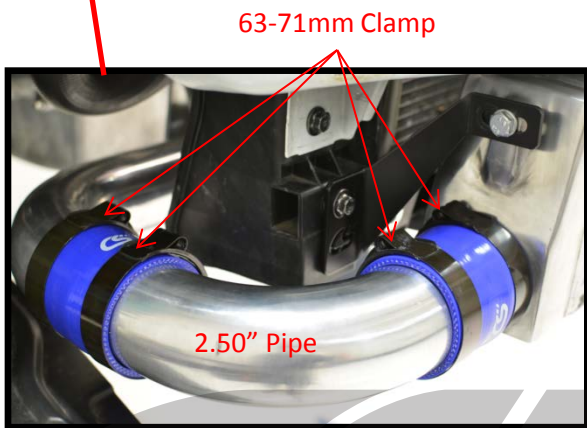

Figure 9b: Passenger's Side

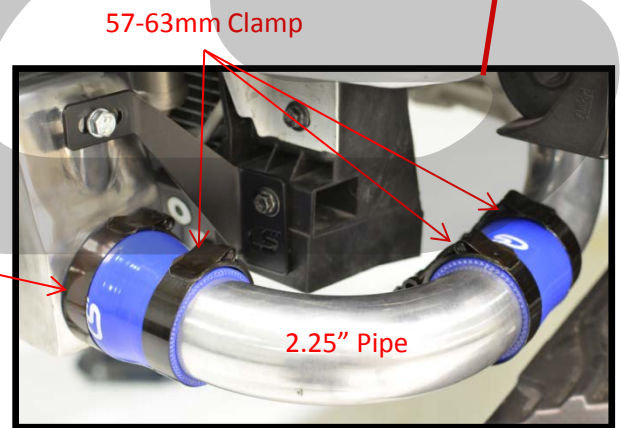

Figure 9c: Driver's Side



Use a small amount of silicone-teflon spray on the inside surface of the silicone couplers to allow easy coupler installation and adjustment.

- a) **Attach the silicone couplers to the 90 degree pipes.** Use the 2.25" coupler on the 2.25" pipe and the 2.50" coupler on the 2.50" pipe.
- b) **Loosely position the clamps** on their respective pipes (see **Figures 9b & 9c**) then mount the 2.25" pipe on the driver's side and the 2.50" pipe on the passenger side.
- c) **Adjust the silicone couplers and intercooler** so there is a minimum of one clamp's width of silicone on all IC pipe ends.
- d) **Tighten the intercooler bolts** with a 13mm socket and ratchet then orientate the clamps into the position shown in **Figures 9b & 9c**. This will allow for easy clamp & silicone adjustment when the bumper is on the car. Tighten the clamps with a 10mm deep socket and ratchet.



Note the orientation of the clamps in Figures 9a-9c. Pointing the bolts downward and towards the engine bay will make it much easier to fix boost leaks with the bumper still installed.

10. OEM Crash Bar Removal (Large Core Only)

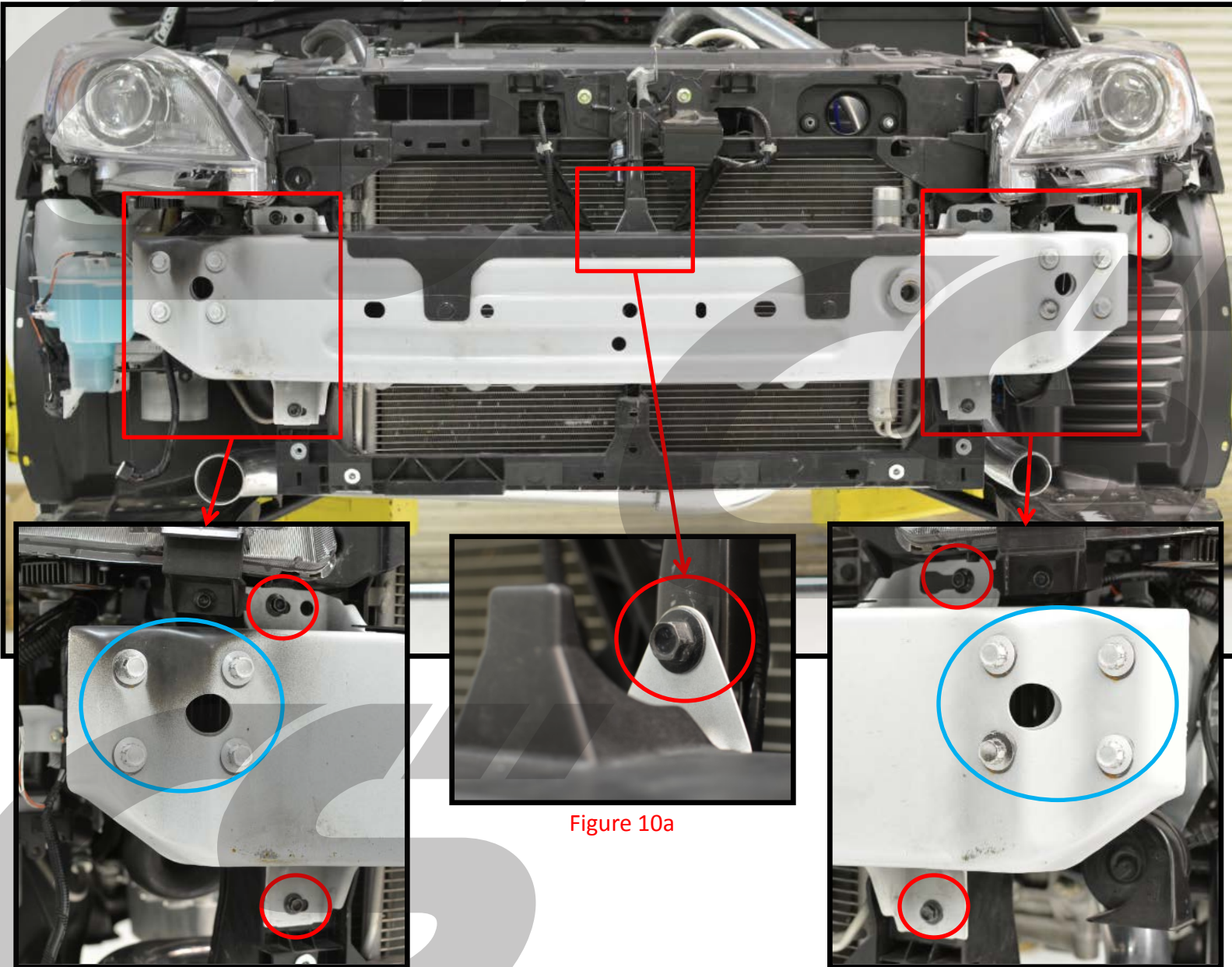

Figure 10a

Figure 10b

Figure 10c

- a) Remove the 10mm bolt attached to the core support, located on the top center of the crash bar. Shown in Figure 10a.
- b) Remove the four 10mm bolts attaching the crash bar to the radiator core assembly. Shown with the red circles in Figures 10b & 10c.
- c) Remove the eight 14mm bolts attaching the crash bar to the chassis. Shown with the blue circles in Figures 10b & 10c.
- d) Remove the OEM crash bar.

11. CorkSport Crash Bar Installation



Figure 11a

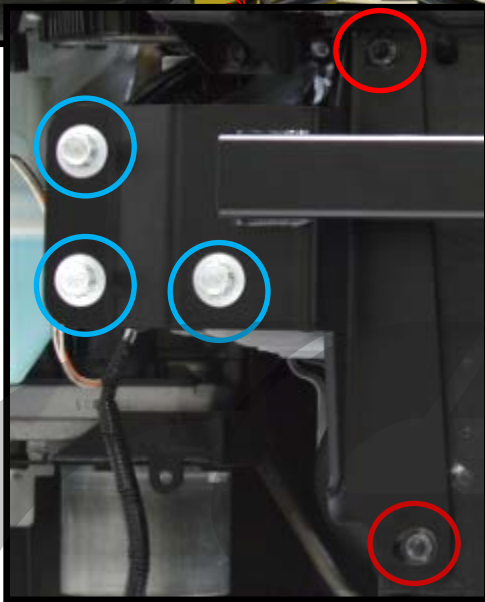

Figure 11b

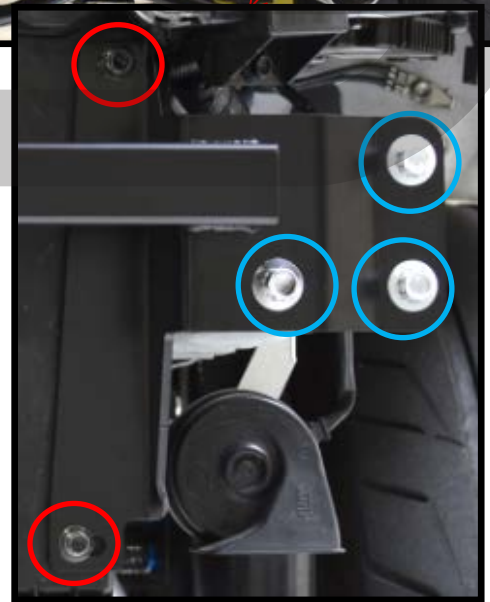

Figure 11c

- a) **Mount the CorkSport crash bar to the vehicle**, using six of the 14mm bolts shown with blue circles in Figures 11b & 11c. Torque to 60-70 ft-lbs.
- b) **Install the four 10mm bolts**, shown with the red circles in Figures 11b & 11c. Torque to 10-12ft-lbs.

12. Large Core Intercooler Installation

- a) Locate the provided M8x1.25x50mm bolts and washers shown in **Figure 12a**.
- b) Install the intercooler on the vehicle using the M8x1.25x50mm bolts. Let it hang loose. Shown with the **red circles** in **Figure 12b** and **12a**.



Figure 12a



Figure 12b

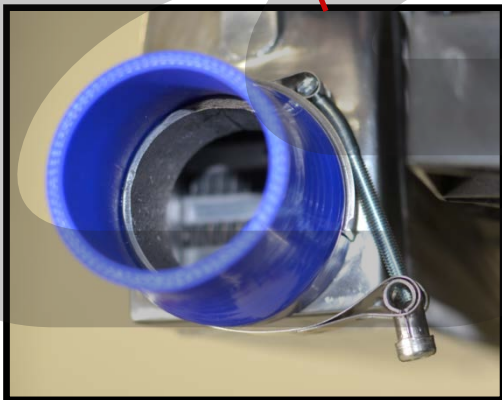

Figure 12c



If you are have difficulty installing the clamp; remove the nut, position the clamp in the orientation in **Figure 12c**, then slide the clamp end over the end of the bolt. Then reinstall the nut.

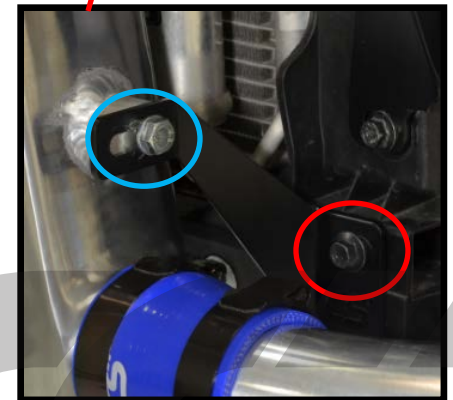

Figure 12d

- c) **Attach the silicone couplers to the intercooler.** Use the 2.25"-2.50" coupler on the driver's side and a 2.50" strait coupler on the passenger's side. Use a 10mm socket and ratchet to tighten the 63-73mm T-bolt clamps.
- d) **Mount the intercooler end brackets.** Install the 10mm OEM bolt shown with the **red circle** in **Figure 12d**. Then install the provided 13mm bolt shown with **blue circle**. Leave both snug, not tight.

13. Large Core 90 Degree IC Piping Installation



63-71mm Clamp

Figure 13a

57-63mm Clamp

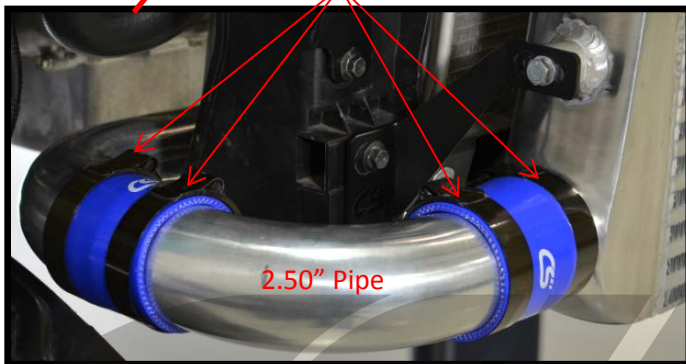

Figure 13b: Passenger's Side

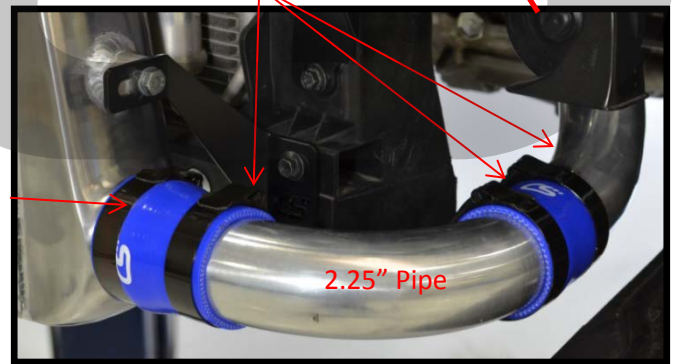

Figure 13c: Driver's Side



Use a small amount of silicone-teflon spray on the inside surface of the silicone couplers to allow easy coupler installation and adjustment.

- a) **Attach the silicone couplers to the 90 degree pipes.** Use the 2.25" coupler on the 2.25" pipe and the 2.50" coupler on the 2.50" pipe.
- b) **Loosely position the clamps** on their respective pipes (see **Figures 13b & 13c**) then mount the 2.25" pipe on the driver's side and the 2.50" pipe on the passenger side.
- c) **Adjust the silicone couplers and intercooler** so there is a minimum of one clamp's width of silicone on all IC pipe ends.
- d) **Tighten the intercooler bolts** with a 13mm socket and ratchet then orientate the clamps into the position shown in **Figures 13b & 13c**. This will allow for easy clamp & silicone adjustment when the bumper is on the car. Tighten the clamps with a 10mm deep socket and ratchet.



Note the orientation of the clamps in Figures 13a-13c. Pointing the bolts downward and towards the engine bay will make it much easier to fix boost leaks with the bumper still installed.

14. Bumper Trimming

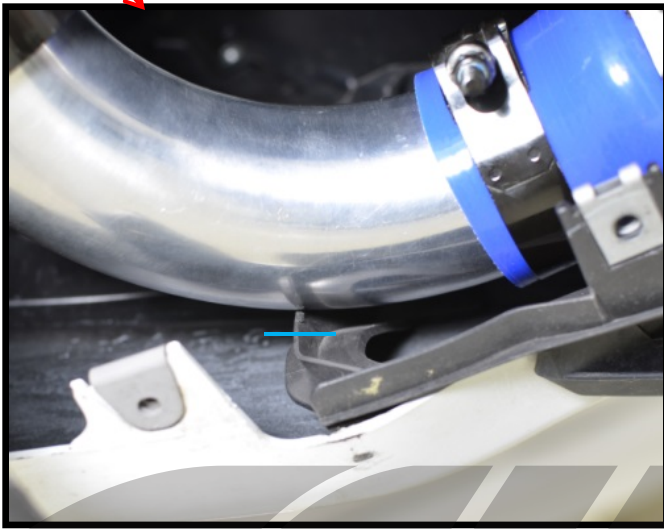
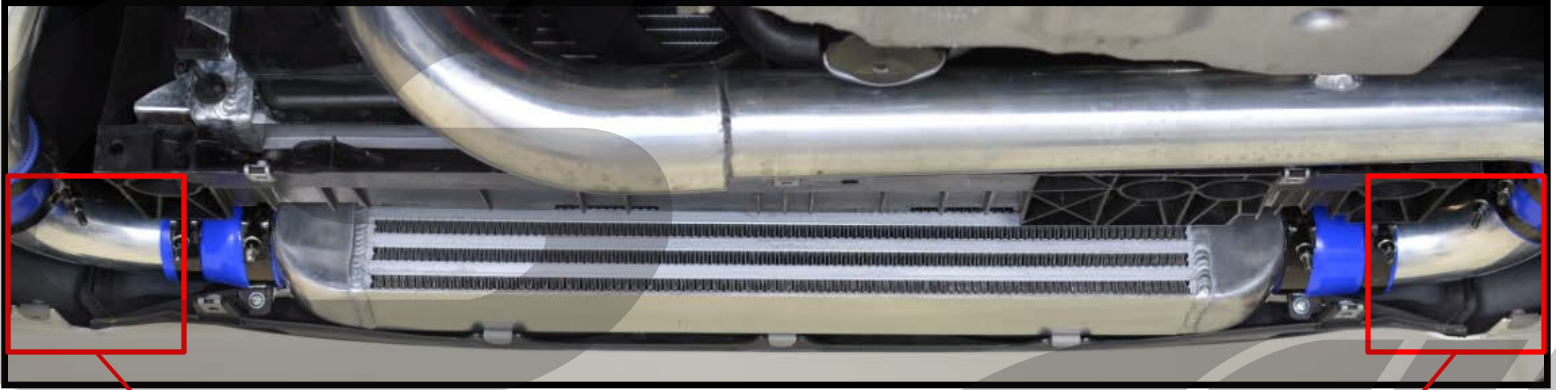

Figure 14a

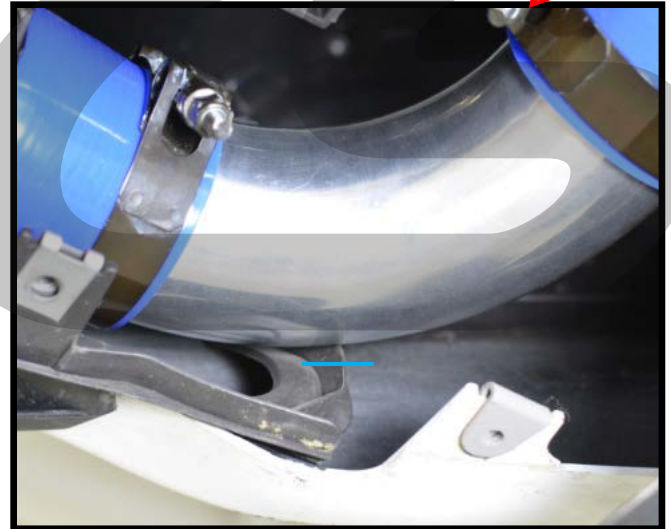

Figure 14b

- Install the bumper and mark the location of the blue lines in Figures 14a & 14b.
- Remove the bumper from the vehicle for trimming.
- Measure 3 inches up from your mark, then cut the 3 inch section of vertical rib off. Shown in Figure 14c.
- Reinstall the bumper to check fitment and trim more if needed.

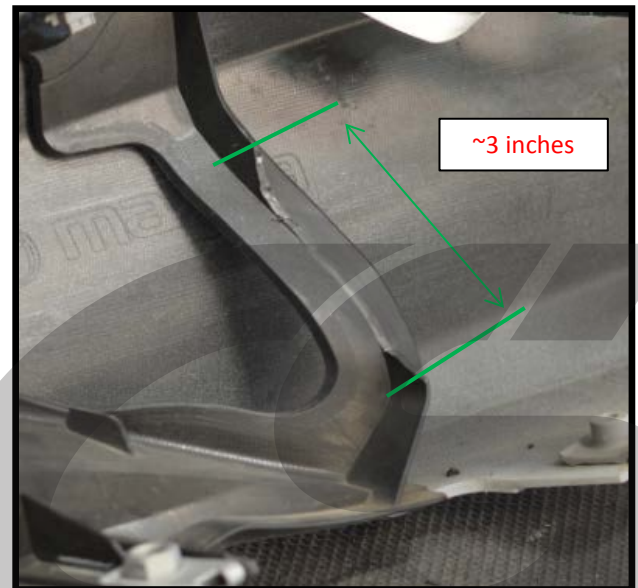

Figure 14c

15. Undertray Trimming

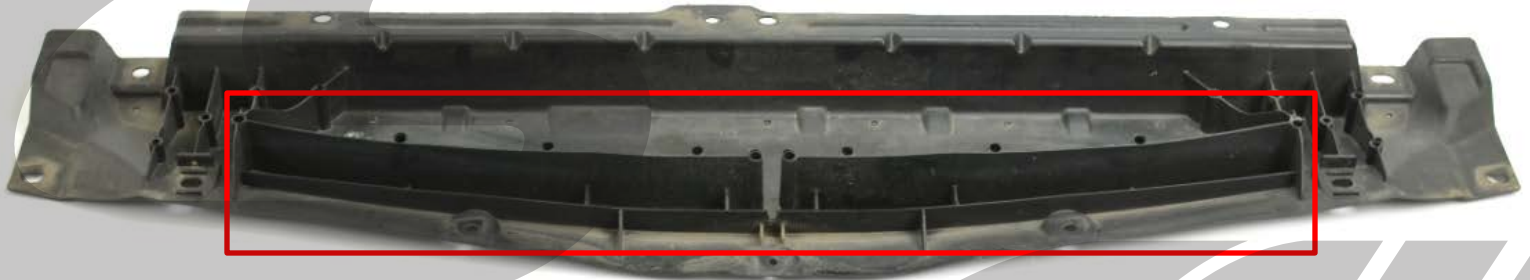

Figure 15a



Figure 15b

- a) Trim off the vertical ribs from the core assembly undertray, red square in Figure 15a.
- b) The result should look like Figure 15b.
- c) A close up of the red square in Figure 15b is shown in Figure 15c.



Figure 15c



Many different tools can be used to trim the undertray and bumper. We used a reciprocating saw with a narrow fine tooth blade. Some other useful tools could be: Razor Blade, Grinder w/cutoff wheel, Vibrating Saw, etc..



This completes the installation of your CorkSport FMIC Kit. Pressure check the system for boost leaks before final installation of the bumper. Reinstall the bumper and undertrays then enjoy!

16. BPV Installation

- a) Locate the provided M6x1.0x25mm flange bolts and flange nuts.
- b) Install the BPV recirc hose onto the BPV (if running recirc).
- c) Mount the BPV onto the cold pipe flange. Install the M6 bolts and nuts through the BPV and holes as shown in **Figure 16a**.
- d) Use a 10mm to torque the bolts to **10-12 ft-lbs**.

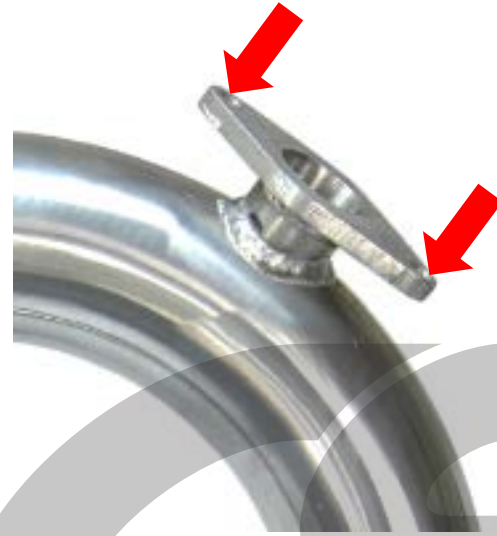

Figure 16a



This completes the installation of your CorkSport FMIC Kit. Pressure check the system for boost leaks before final installation of the bumper. Reinstall the bumper and undertrays then enjoy!

What's Next:

[CORKSPORT 2010-2013 Mazdaspeed 3 Downpipe](#)



Get maximum turbo performance and dramatically increase torque with the Mazdaspeed 3 Power Series Downpipe. The CorkSport downpipe has been expertly designed to replace the restrictive element in the Mazdaspeed 3 stock downpipe. Mandrel bent piping is used to create smooth exhaust flow for dramatic increases in power. For lasting corrosion resistance and reduced heat transfer to the engine bay, the CorkSport MS3 downpipe uses polished 3" 304 stainless steel and features TIG welds that offer superior arc and weld puddle control for a cleaner appearance and precise weld bead control

[CORKSPORT Mazdaspeed MZR Bypass Valve](#)

Add performance and style while protecting your turbo with the Patent Pending CorkSport Mazdaspeed MZR Bypass Valve. Using an innovative patent pending design utilizing a wave spring, we were able to reduce the spring height of the OEM Bypass Valve by 50%. This size reduction provides the same amount of force, while accelerating the speed of the valve. By increasing speed the Bypass Valve effectively increases the life of your turbo by preventing premature wear since the BPV can safely move at speeds 33% faster than stock or other valves. With the extra space allowed by the spring we were able to increase piston size by over 30%.



[CORKSPORT Mazdaspeed Performance Drop-In Turbocharger](#)



Experience a boost in performance with our **drop-in Mazdaspeed turbocharger**. It easily bolts in and replaces your undersized OEM turbo with NO mechanical modifications. The CorkSport turbo supports a range of 250-450* horsepower in your Mazdaspeed. If your Mazdaspeed 3 or Mazdaspeed 6 turbo is worn out or is smoking, you need our turbo. Add the power without the hassle today!

Designed with you in mind, the **CorkSport turbo upgrade fits the Gen 1 and Gen 2 Mazdaspeed 3 and the 2006-2007 Mazdaspeed 6**. No extra modifications are required with our turbo. Nor will you experience the pain of running out for missing parts mid-installation. Our turbocharger comes with all the necessities you need for increased power performance

Need Help With Your Installation?
Call (360) 260-CORK